







Assembly Instructions, #10402 Delton Recliner Wedge Table

A: Top Assembly	
B: (4) Legs	
C: Shelf	
D: (8) Bolts	
E: (8) Flat Washers	
F: (8) Lock Washers	
G: Allen Wrench	

Step 1

Place table upside down on a soft surface. Fasten the legs with (4) bolts, flat washers and lock washers using the Allen wrench. Do not tighten yet.

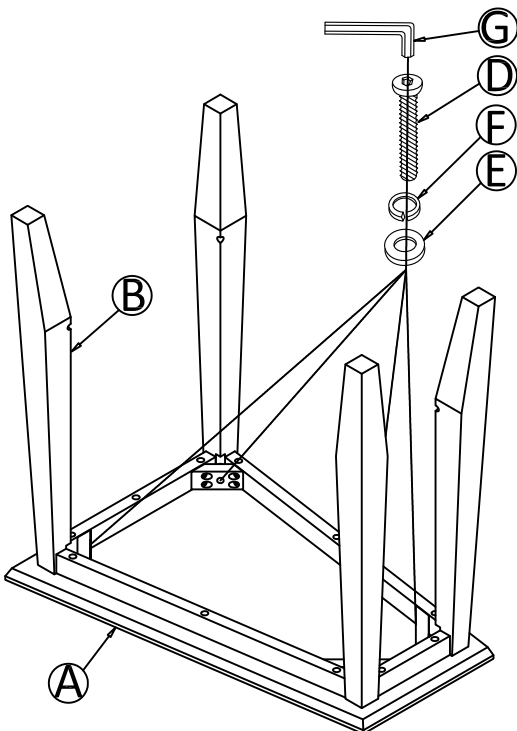

Step 2

Fasten the shelf to the legs with (4) bolts and flat washers and lock washers, tighten bolts. Ask for another set of hands to help hold the shelf while the bolts are inserted. Now tighten these bolts and the other bolts in step 1.

