



Extended Warranty
Sign Up

E-1

Welcome home!

VFD8179

**TEAMSON HOME
2 Tier Fountain**

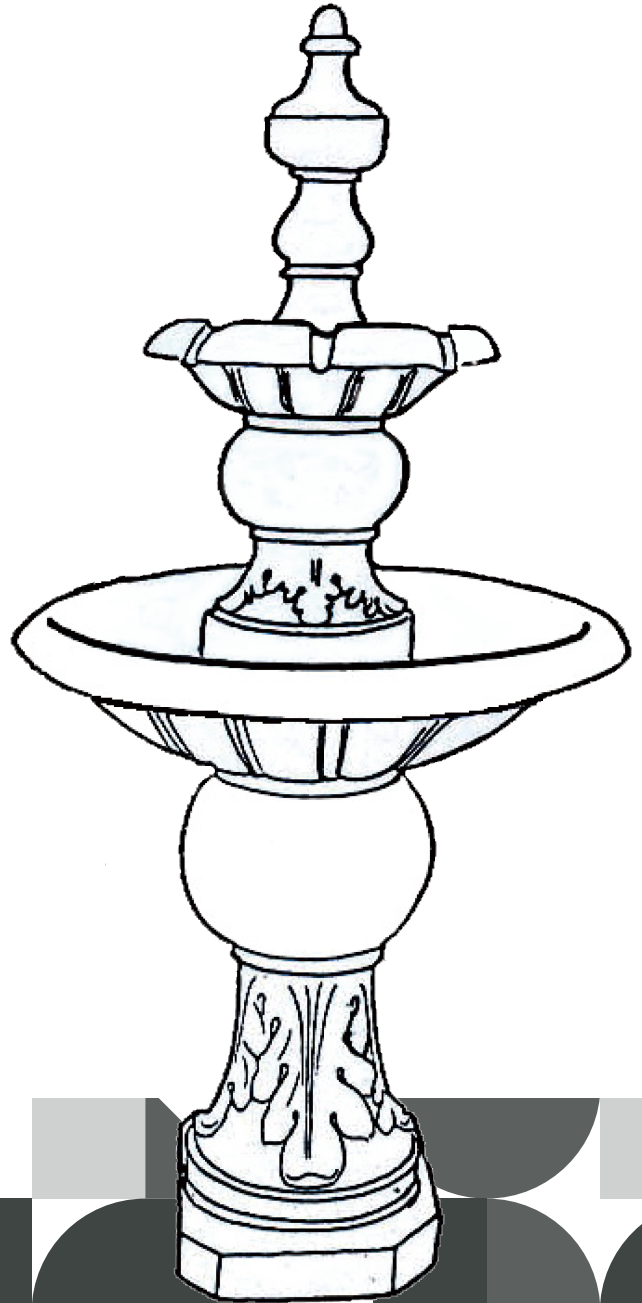

Warranty

All components are warranted by the manufacturer for a period of 30 days after the date of purchase by the original owner against defects in materials & workmanship under normal use. If it is appropriate to replace your product due to specific defects, the manufacturer will replace the purchase with the same product or a comparable product.

For specific instructions on how to obtain warranty service for your product, please contact Customer Service using the contact information provided.

Global Customer Service

USA



✉ support@teamson.com

+1(800)935-3959

Mon - Fri 10:00am ~ 2:00pm EST

EU/UK



✉ support@teamson.co.uk

+44(0)1952-916-050

Mon - Thu 9:00am ~ 5:00pm GMT

Friday 9:00am ~ 4:00pm GMT

ASIA

深圳办公室:

✉ sales_ec@teamson.com

+86(0755)8885-3558. 分机号331

Mon - Sat 9:00am ~ 5:00pm GMT+8

台北办公室:



✉ sales_ec@teamson.com

+886(2)2556-6268

Mon - Fri 9:00am ~ 5:00pm GMT+8

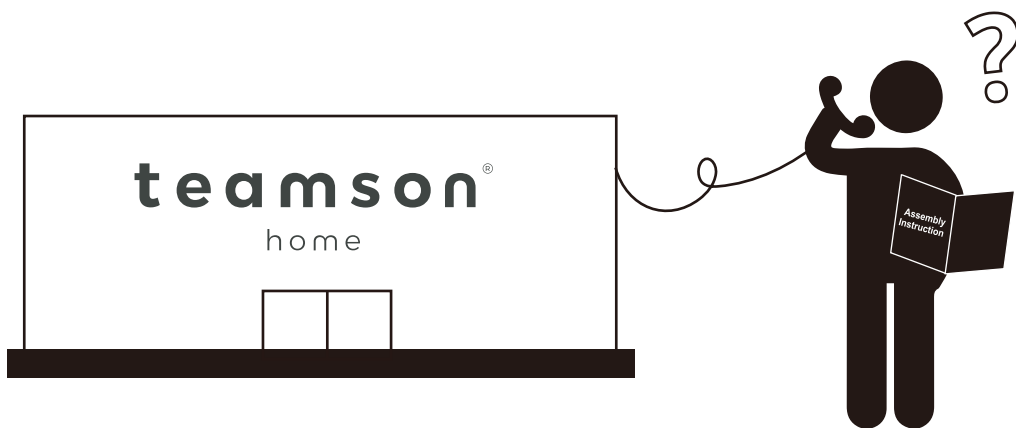
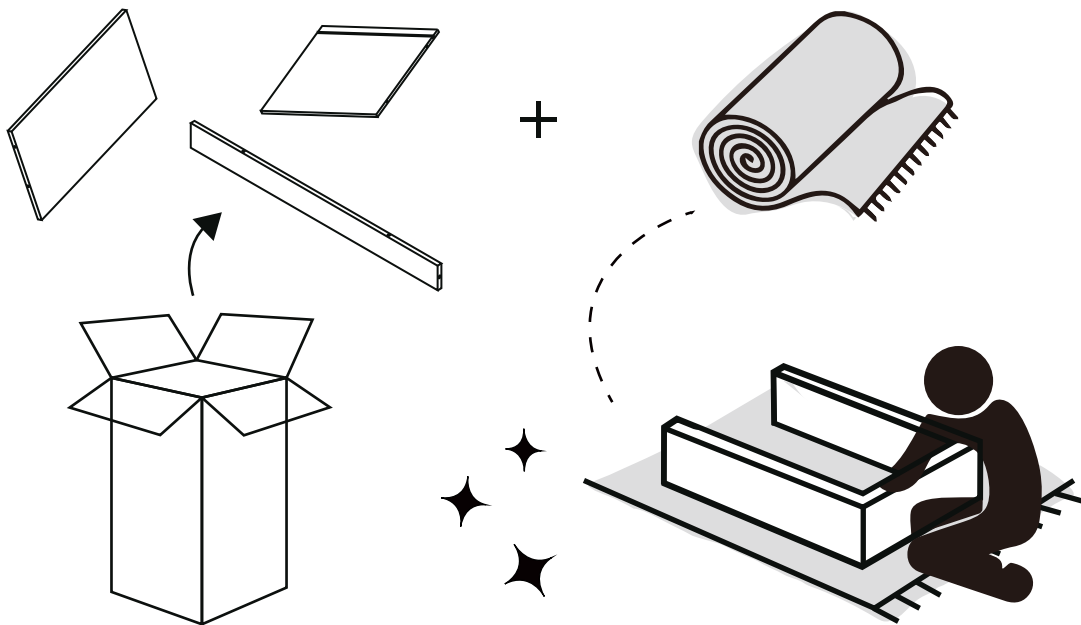
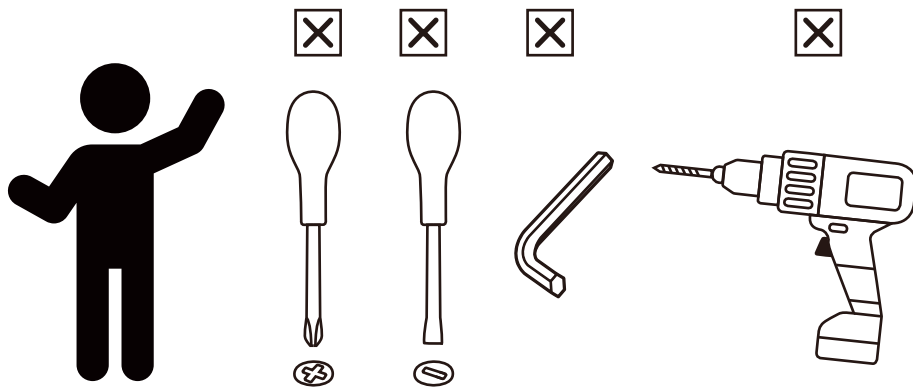

** Got questions? Please have your product code (on the first page of this instruction, e.g. VFD8179) and the order number ready, give us a call or email us through our customer care support! We are always ready to assist you!

Assembly Instruction

1. Unpack the contents of the box and check to make sure that all items are accounted for and in good condition.
2. Select a flat, level surface for the assembly and final location of your fountain.
3. Place the base onto the earth flat(Keep the connector upright). Lead the pump power cord through the cord tube in the basin to the cord notch at the underside of the base. Align the arrow sign on both the fountain basin and the base, and then twist the fountain basin to the base clockwise until the parts are secured together. And place the pump upright onto the fountain basin.To avoid the water leaking along from the pump cord's pipe, please insert this water sealed cap on top of the pump cord's pipe. (Step.1)
4. Align the arrow sign on both the basin and middle pedestal, and twist the middle pedestal to the basin clockwise until the parts are secured together, then align the middle pedestal and middle basin and twist it for lock (Step.2)
5. Insert the supply tube through the pipe of the top of the middle basin and middle pedestal and lead the water supply tube put of the pump house, align the fountain top and middle basin, and insert the fountain top to the middle basin directly. Insert the water supply tube from the underside of the middle basin into the pump outlet on top of the pump.Place the pump house cover to the pump house door.(Step.3)
6. Add clean water into the fountain basin. The water level should be approximately 1 in. / 25 mm lower than the edge of the basin. Connect the pump to a GFCI outlet and the product will begin to function as intended. (Step. 4)
7. If the pump runs with low or high water circulation Check and adjust the regulator dial or slide on the front of the pump. Adjust the dial/slide towards (+) to increase water flow or towards (-) to decrease water flow.
8. To eliminate the possibility of water damage around your fountain, check for leaks and excessive splashing after the initial setup of your fountain. It is highly recommended that this fountain be placed in an area where it cannot be damaged that might cause damaged with the fountain .
9. Do not leave your fountain running for extended periods of time when no one is present to observe the performance.
10. Check the area around your fountain on a regular basis to ensure that there is no leakage.

Important Safety Instruction

TRANSFORMERS

When using electrical products, basic precautions should always be practiced including the following:

1. READ AND FOLLOW ALL SAFETY INSTRUCTIONS.
2. Read and follow all instructions that are on the product or provided with the product.
3. For a cord-connected or direct plug-in power unit, do not use an extension cord.
4. Reference the National Electrical Code, ANSI/NFPA 70, specifically for the installation of wiring and clearances from power and lighting conductors.
5. Installation work and electrical wiring must be done by qualified person(s) in accordance with all applicable codes and standards, including fire-rated construction.
6. For a cord-connected or direct plug-in power unit, do not install or use within 3.05 m / 10 ft of a pool.
7. For a cord-connected or direct plug-in power unit, do not use in a bathroom.
8. For a cord-connected power unit, user should pay attention to below statement
 - ▲WARNING: Risk of Electric Shock. When used outdoors, install only to a covered Class A GFCI protected receptacle that is weatherproof with the power unit connected to the receptacle. If one is not provided, contact a qualified electrician or proper installation. Ensure that the power unit and cord do not interfere with completely closing the receptacle cover.
9. ▲WARNING: Risk of Fire. Installation involves special wiring methods to run wiring through a building structure. Consult a qualified electrician.
10. For a unit intended to be mounted greater than 0.3 m / 1 ft from the ground surface:
 - ▲WARNING: Risk of Electric Shock. Mount the unit at a height greater than 0.3 m / 1 ft from the ground surface.

PUMP

⚠ CAUTIONS

1. The pump has been evaluated for use with water only.
2. Risk of electric shock.
3. Do not remove cord and strain relief. Do not connect conduit to pump.
4. Do not use the pump in water exceeding 86°F / 30°C.
5. Do not use the pump in flammable liquids.
6. Do not use the pump for industrial purposes.
7. Do not use the pump in vehicles or on board ships or aircraft or swimming pools.
8. Do not use the pump in location where special conditions prevail, such as the presence of a corrosive or explosive atmosphere (dust, vapor or gas).
9. Do not let the pump run dry. Pump must be completely submerged for proper operation and cooling.
10. Do not lift the pump by its power cord.
11. Keep the plug dry. Do not expose the plug to water or steam.
12. Before connecting to the power source, make sure that the pump is assembled and completely submerged in water.
13. Always disconnect the pump from the power source before performing any maintenance on the pump, lights (if equipped), or fountain.
14. Do not exceed the voltage shown on the pump.
15. Check the water level regularly to ensure the pump is completely submerged during operation.
The pump should be fully submerged during operation.
16. Do not add water while operating the product. Always disconnect the pump from the power source before adding water.

⚠ WARNING

1. Risk of electric shock. This pump is supplied with a grounding conductor and grounding-type attachment plug.
To reduce the risk of electric shock, be certain that it is connected only to a properly grounded, grounding-type receptacle.
2. To reduce the risk of electric shock, use only on portable self-contained fountains no larger than 5 ft / 1.52 m in any dimension.
3. If equipped with a 3-prong, grounded type plug, do not remove the grounding pin from the plug on the power cord.



Scan for assembly instructions.

Care and Maintenance

1. Distilled water is always recommended to fill your fountain. Distilled water is pure and should have no minerals or sediment in it. It will extend the life of the pump and the time between cleanings. If distilled water is not an option, use filtered water, as water directly from your tap will generally have minerals and chemicals that can build up and leave behind residue on your fountain.
2. Check the water level regularly to ensure the pump is completely submerged during operation. This is necessary to ensure proper cooling of the pump and prevent overheating. In summer months, or dry, hot climates, water evaporates very quickly, so it may be necessary to check the water level every day. The rate of water evaporation will also be greater with larger fountains, with more surface area, than smaller fountains.
3. Keep the fountain water and pump clean and clear of debris. If placed under a tree or near vegetation, you may need to scoop out leaves and other debris every other day. Water treatments that prevent algae growth and mineral deposits are available at your local home & garden stores. Do not use bleach as it may be harmful to pets and wildlife and may also damage the finish of the fountain.
4. Clean the fountain monthly to prevent mineral deposits and contamination which may clog the pump. Disconnect the pump from the power source and empty the water from the fountain. Use any gentle household cleanser and a soft brush or cloth to clean the fountain. Avoid using any harsh chemicals, abrasives or rough scrubbing, as this could damage the finish on your fountain. The frequency of cleaning may vary depending on the location of your fountain.
5. Use a pre-filter on your pump if available to prevent it from clogging with leaves or other debris.
6. Regular cleaning of the pump will be necessary depending upon the environment in which it is operated. Clean the pump when it is visibly soiled or when a noticeable decrease in performance is detected. Failure to clean the pump will result in overheating of the pump.
7. Before cleaning, always disconnect the pump from the power source.
8. Disassemble the pump by removing the filter and regulator/impeller plate. Remove the impeller/rotor assembly by gently pulling on the impeller blades. Use a soft cloth or brush to clean the area inside of the pump housing. Clean the filter, gland and impeller in warm soapy water. Reassemble the pump and inspect for proper operation. Please see the diagram which matches your pump below:
9. Although it is not required, pumps generally last longer if left running continuously as it reduces the wear from starting and stopping. However, running the pump continuously will also use a little more electricity, and will require you to refill the fountain more frequently. If mosquitoes are a problem in your area, it is recommended to run the fountain as much as possible to prevent standing water, where mosquitoes breed. You may also add a few drops of anti-mosquito water treatment, available at your local home and garden store, to the fountain water.
10. Place the fountain in a location that will not be damaged should the area come in contact with liquids.
11. To eliminate water damage to floors and/or surrounding fountain areas, check for leaks and excessive splashing after initial installation and on a regular basis.
12. If your fountain develops a leak and a visible crack is detected, plastic epoxy or Clear Silicone II sealant may be used to seal it. If the fountain leaks without a visible crack, turn the pump off, fill the fountain and let the fountain sit for one week. If there is a crack, it will appear white. Remember to keep the water $\frac{3}{4}$ full as will evaporate over time. Seal the leak with plastic epoxy or Clear Silicone II sealant.
13. If the fountain is not in use for an extended period of time, disconnect the power and empty all the water from the fountain. Do not tip the fountain to empty the water. Use a siphon pump or a small bucket.
14. The fountain should not be operated in temperatures below 41° Fahrenheit / 5° Celsius to prevent frost damage. During winter months, before the temperature hits freezing, disconnect the power, drain your fountain and store it in a heated area. If the fountain is stored outdoors in freezing temperature, disconnect the power, empty all the water from the fountain, remove the pump and any lights if possible, make sure it is completely dry and cover it with a tarpaulin. Any water left in the fountain may freeze and expand causing the fountain to crack.
15. If your fountain is equipped with an independent light set, you can use an outlet timer to have the lights activate during night time hours. Please note, on some models the lights cannot be operated independently from the pump so the lights are on, when the pump is on.

Troubleshooting Guide

If the pump does not operate...

1. Check to make sure the pump is connected to a power source.
2. Check the water level to ensure the pump is completely submerged. Add water as needed.

If the pump operates, but, there is no water flow...

1. Check the water level to ensure the pump is completely submerged. Add water as needed.
2. Check the supply tube for any kinks or folds and correct.

If the pump operates, but there is no water flow and the pump is fully submerged and the supply tubing has no kinks...

1. Disconnect the pump from the power source.
2. Disconnect the supply tube from the pump outlet.
3. Check for clogs or holes and clean the tubing inside and outside if necessary.
4. Check for clogs and clean the pump inlets and outlet if necessary.
5. Place the pump back into the water outlet side up and then re-connect the pump to the power source.
6. Once the water begins to flow from the pump, re-connect the supply tubing to the pump outlet.
7. Check for any air trapped in the water supply tube which may prevent the pump from working.

If the pump runs with low or high water circulation...

1. Check and adjust the regulator dial or slide on the front of the pump. Adjust the dial/slide towards (+) to increase water flow or towards (-) to decrease water flow.

If the pump operates, but the water flow is uneven or non-existent and the pump makes noise...

1. Check the impeller assembly for wear. Remove the front cover and regulator/impeller plate and remove the impeller assembly. Clean the impeller assembly and inspect for wear. If the rotor spins freely from the magnetic body, the impeller assembly is worn and needs to be replaced. Contact customer service for replacement parts.

If the pump starts to make noise...

1. Check the water level to ensure the pump is completely submerged. If the water level drops below the pump intake, it may suck in air and cause the noise or the pump to completely stop working.
2. Move the pump away from the sides of the basin or place a piece of foam or sponge underneath the pump to isolate any vibration which causes the noise.

If the water starts to foam...

1. Check the water level to ensure the pump is completely submerged. If the water level drops below the pump intake, it may suck in air and cause the pump to 'spit' and foam the water.
2. Add a few drops of anti-foaming water treatment, available at your local home and garden store, to the fountain water.

If the water flow is uneven...

1. Gently sweep across the water surface to achieve even water flow across the face of the fountain.
2. Check the top of the basin to ensure it is level. If not, shim the basin from the bottom until the top spillway is level or has achieved even water flow all around.

Warranty

LIMITATIONS

All components are warranted by the manufacturer for a period of 30 days after the date of purchase by the original owner against defects in materials & workmanship under normal use. If it is appropriate to replace your product due to specific defects, the manufacturer will replace the purchase with the same product or a comparable product.

GENERAL TERMS & CONDITIONS

1. Proof of purchase is required to request a claim under this warranty.
2. This warranty applies only to manufacturer errors & defects. The warranty applies to the following:
 - a. Breaks and cracks in the product that originated with the manufacturer
 - b. Missing pieces
 - c. Stains that occurred during the manufacturing process
3. This warranty does not apply to the following:
 - a. Damage due to improper loading, handling, or transportation
 - b. Any costs associated with the installation and removal of products or parts subject to this warranty
 - c. Acts of God
 - d. Products which have been subject to negligence, abuse, accident, misapplication, tampering, alteration, or modification
 - e. Products which have been subject to improper installation, operation, maintenance, repair, or storage
 - f. Products which have been subject to defects that occur when this product is used incorrectly and/or outside of normal application purposes
 - g. Products which have had, including but not limited to, operational failures caused by corrosion, rust, or other foreign materials in the system, or operation at pressures in excess of recommended maximums
 - h. All other possible defects not mentioned here that would not have occurred during manufacturing or during correct, routine use of the item

INSTRUCTIONS

For specific instructions on how to obtain warranty service for your product, please contact Customer Service using the contact information provided. In most circumstances, you will need to return your product either in its original packaging or in equally protective packaging to the address specified by Customer Service.

Before delivering your product for warranty service, it is your responsibility to remove all personal items and belongings you may have stored in your product. Teamson is not responsible for the possible loss, destruction, or damage of any personal items or belongings that have been sent alongside the product.

DISCLAIMER

Any oral statements made about the product by the seller, the manufacturer, the representatives, or any other parties do not constitute warranties, should not be relied upon by the user, and are not part of the contract for sale. The sellers and manufacturers only obligation, and buyers only remedy shall be for the manufacturer to either replace and /or repair at the manufacturers sole discretion, the product as described above. Neither seller nor the manufacturer shall be liable for any injury, loss or damages for lost profits, lost sales, injury to person or property, or any other incidental or consequential loss arising from any cause whatsoever, no matter whether based upon warranty, contract, negligence or other misuse, and the buyer and user agree that no other remedy shall be available to them. Before using, the buyer and user shall determine the suitability of the product for intended use, and assume all risk and liability whatsoever in connection therewith. The warranty and remedy described in this limited warranty is an exclusive warranty and remedy in lieu of any other warranty or remedy expressed or implied. All other warranties and remedies are hereby expressly excluded, including but not limited to any implied warranty of merchantability of fitness for any particular purpose.

OTHER LEGAL RIGHTS

This warranty gives the buyer and user specific legal rights, and buyer and user may also have other rights which vary from state to state. Some states do not allow exclusions or limitation of incidental or consequential damages, so the above limitations or exclusions may not apply to you.

THANK YOU

We appreciate the trust and confidence you have placed in Teamson through the purchase of this product. We strive to continually create quality products designed to enhance your home and life. Visit us online to see our full line of products available for your home décor, toy, and pet needs. Thank you for choosing Teamson!



**Scan for assembly
instructions.**

Exploded Drawing

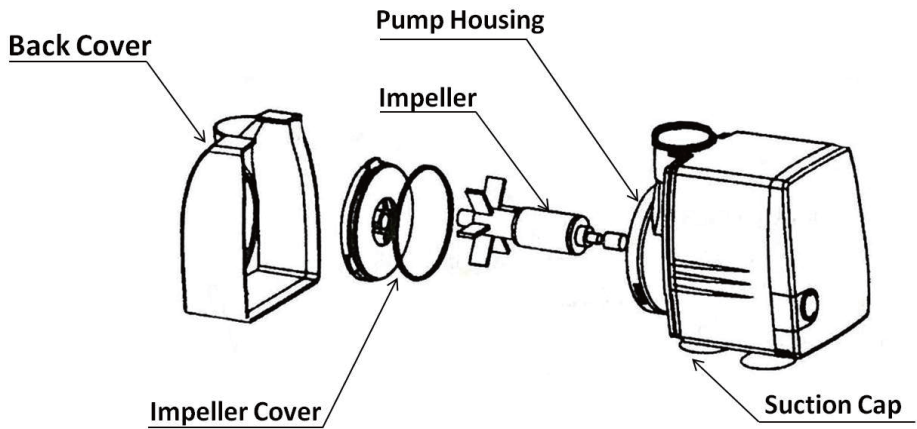
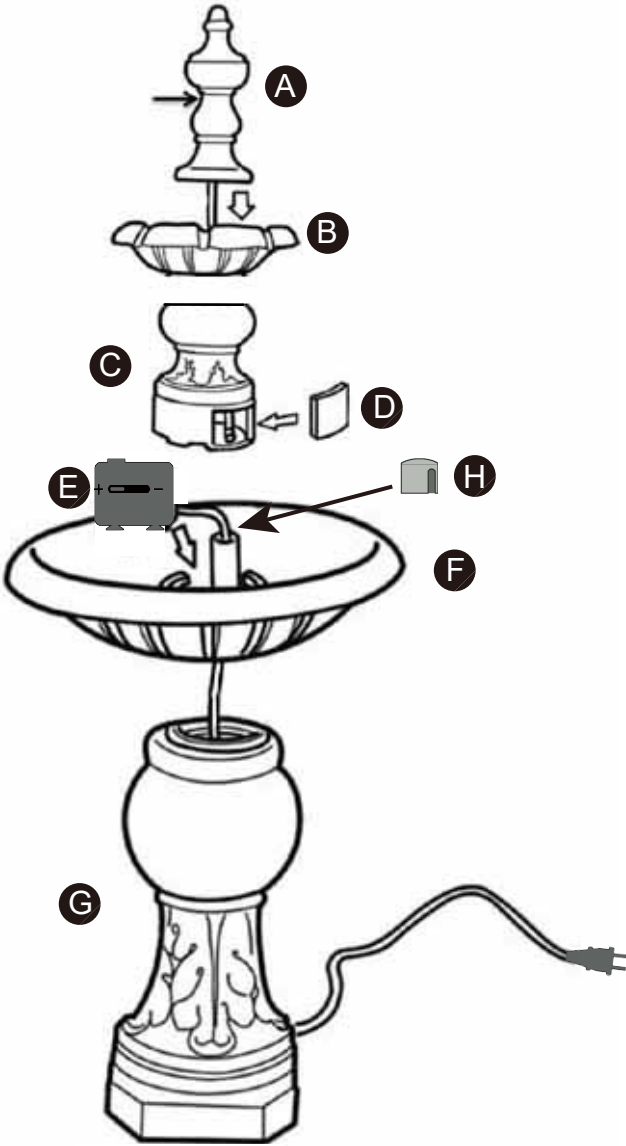

Scan for assembly instructions.

Product Parts

A



Fountain Top

1 PC

B



Middle Basin

1 PC

C



Middle Pedestal

1 PC

D



Pump House Cover

1 PC

E



Pump

1 PC

F



Basin

1 PC

G



Base

1 PC

H



Cap

1 PC



Scan for assembly instructions.

Step 1

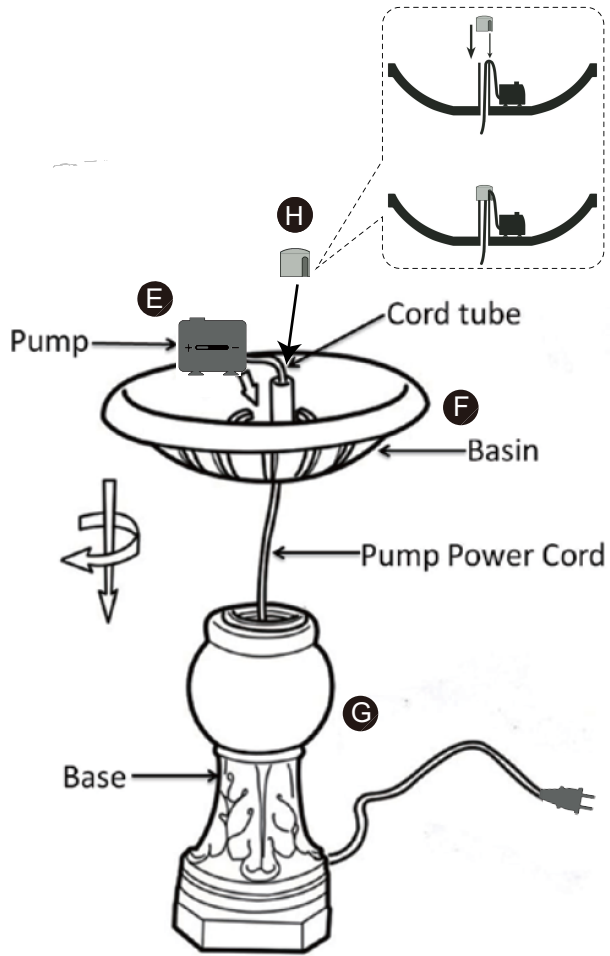

Step 2

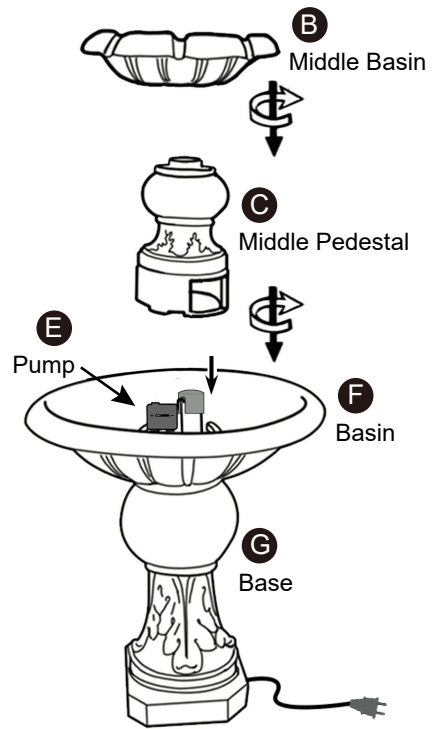

Step 3

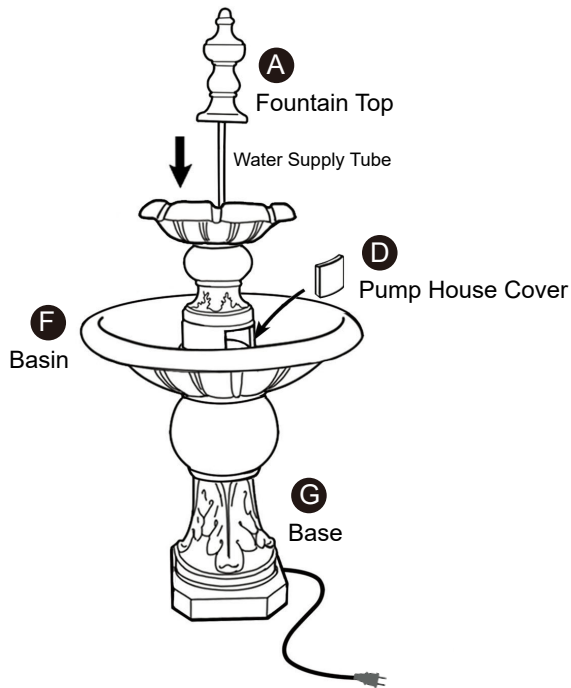

Step 4

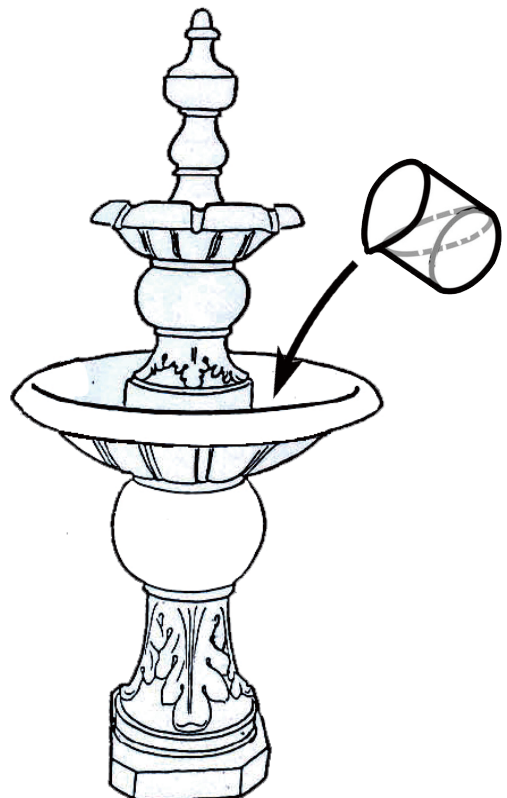

Scan for assembly instructions.