

Thank you for choosing Sunnydaze Decor. We stand behind our brand and the quality of the items we sell. Replacement parts or products can be requested with the 1-year warranty period. Proof of purchase must be provided. This includes the date of the purchase as well as photos of the product defect. Photos are used to determine the cause of the defect and to provide future quality control. The request will be reviewed, and replacement pieces will be sent at our discretion. For warranty information, visit <https://tiny.cc/SunnydazeWarranty>



If you have any questions, comments or concerns, feel free to contact us by phone at 833-982-1977, by email: customerservice@sunnydazedecor.com, or via our contact us page at <https://tiny.cc/SunnydazeContact>

CROSSWEAVE PATIO TABLE

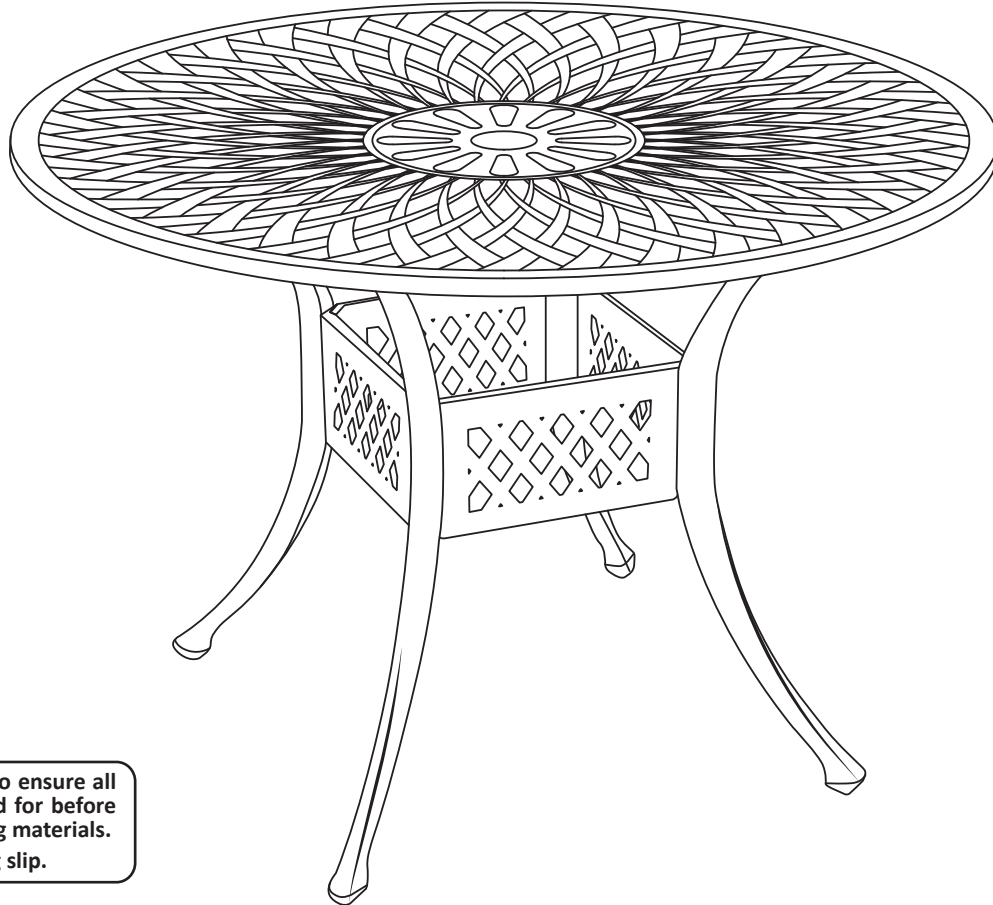

YUK-809

Review all assembly and care information before using this product. Save this manual for future reference.
Assemble components on a soft, clean surface to avoid damaging the finish.







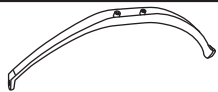

 Inspect packaging to ensure all parts are accounted for before disposing of packing materials.
 Save the packing slip.

145
pounds
65.8 kg
Weight Capacity

No.	PARTS		QTY.
E		Tabletop	1
F		Panel	4
G		Leg	4

⚠ WARNING ⚠
CHOKING HAZARD — This item contains small parts that can be swallowed. Keep children and pets away during assembly.

TOOLS REQUIRED (not included)	
	Hex Key
	Spanner

No.	HARDWARE		QTY.
3		M8x34mm Grub Screw	12
4		Flat Washer	12
5		Split Washer	12
6		Nut	12

 **SCAN THIS CODE WITH YOUR SMARTPHONE TO VIEW OUR ASSEMBLY VIDEO**

ASSEMBLY

STEP 1

E: 1
3: 4

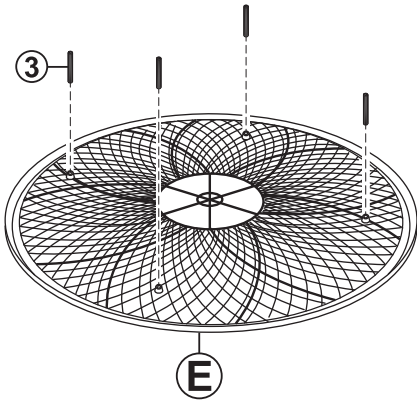

Place Tabletop (E) face down on a soft, clean surface. Firmly secure four Grub Screws (3) to the tabletop.

STEP 2

G: 4
3: 8

x4

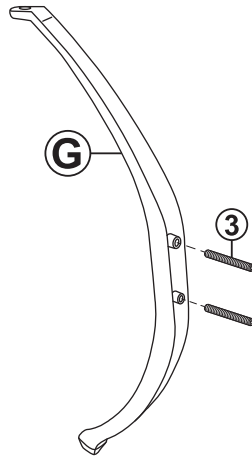

Firmly secure two Grub Screws (3) into each Leg (G).

STEP 3

4: 4
5: 4
6: 4

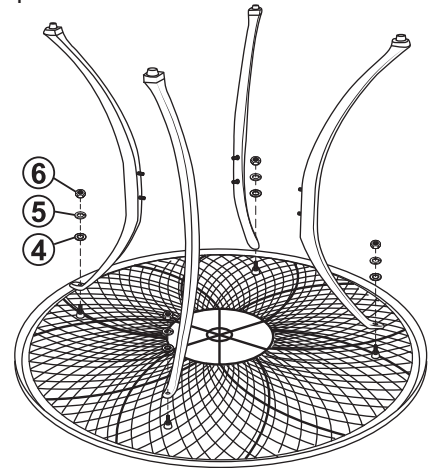

Loosely fasten each leg to the tabletop using Flat Washer (4), Split Washer (5), and Nut (6).

STEP 4

F: 4
4: 8
5: 8
6: 8

! IMPORTANT: Ensure Panels (F) align correctly.

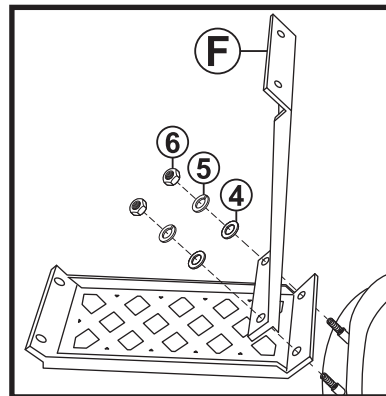
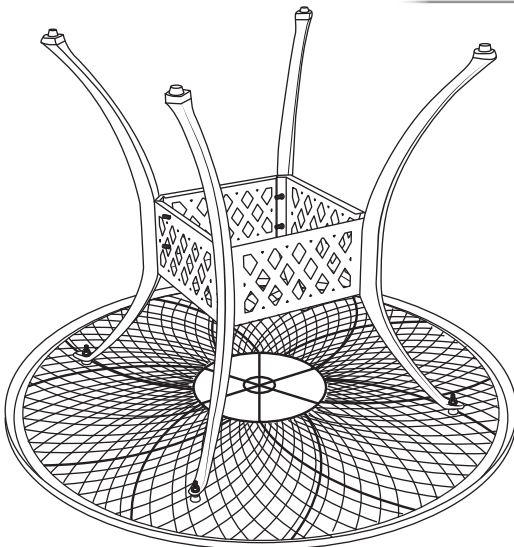
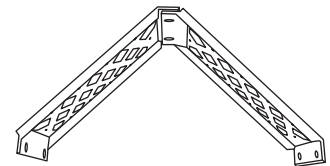
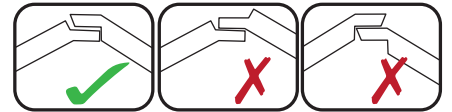
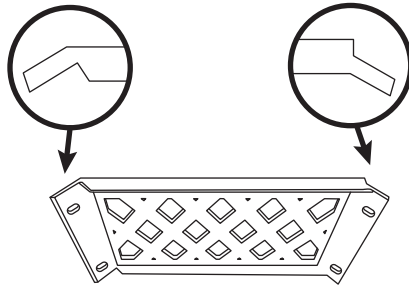

Fasten the four Panels (F) to the legs using Flat Washers (4), Split Washers (5), and Nuts (6).

Care & Maintenance

SAFE USE: For residential use only. Only use on a flat, level surface. Never sit or stand on any part of this unit.

EXPOSURE: Over time, sunlight may cause the finish to fade. Long-term exposure to moisture may cause hardware to rust.

INSPECT: Periodically check assembly points and tighten fittings as necessary.

CARE & STORAGE: Protect this item from inclement weather, especially ice and snow. Move to a dry indoor location when not in use. Covering while in storage is recommended to help prevent dust build-up.

SCRATCHES: The powder coating on this product is tough & durable but, even under normal use, some scratching is inevitable. Scratches can be repaired with a rust-resistant paint (not included).

WARNING: THE ONE-YEAR WARRANTY DOES NOT COVER DAMAGES OR DEFECTS CAUSED BY THE APPLICATION OF CHEMICAL TREATMENTS, PROTECTIVE COATINGS, TOUCH-UP PAINT, OR CLEANING PRODUCTS.

Cleaning

 HAND-WASH ONLY

 DO NOT USE BLEACH

 DO NOT USE A PRESSURE WASHER

Mix warm water with mild detergent. Use a soft cloth to hand-wash the furniture. Rinse thoroughly with clean water, ensuring all soap residue has been removed. To prevent water spotting, dry with a soft, lint-free cloth.

SAFETY STATEMENTS & WARNINGS

- Do not exceed the weight capacity.
- Do not sit or stand on the table.
- Inspect hardware often and tighten as necessary.
- Do not use harsh chemicals or abrasive materials to clean this unit.
- This product is for residential use only; institutional or commercial use will void this warranty.

Any modification to the product or failure to follow recommended care will void the product warranty.

If you experience issues with assembly or the product was damaged during shipping, please contact our customer service team through one of the methods mentioned at the top of page 1.

Please have the item number and order information ready to expedite response time.

WARNING!

Manufacturer and seller expressly disclaim any and all liability from personal injury, property damage or loss, whether direct or indirect, or incidental, resulting from the incorrect attachment, improper use, inadequate maintenance, or neglect of this product.