

USE AND CARE GUIDE

SINGLE HEAD COMMERCIAL SECURITY FLOOD LIGHT

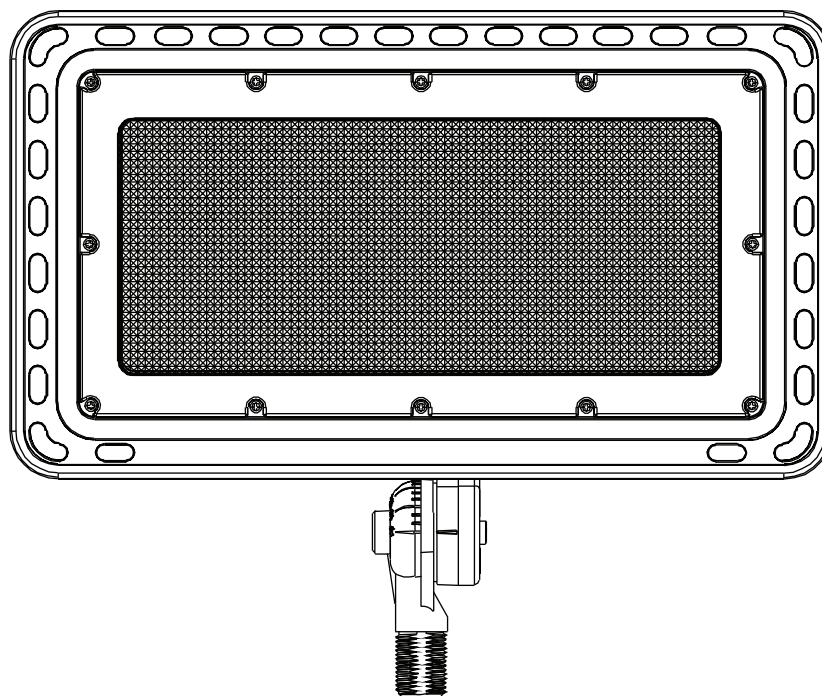

DUSK TO DAWN OPERATION

READ BEFORE INSTALLATION
SAVE THESE INSTRUCTIONS

Questions, problems, missing parts? Before returning to the store,
call Feit Electric Customer Service
8 a.m. - 5 p.m., PST, Monday - Friday

1-866-326-BULB (2852)
FEIT.COM

THANK YOU

We appreciate the trust and confidence you have placed in Feit Electric through the purchase of this LED yard light fixture. We strive to continually create quality products designed to enhance your home. Visit us online to see our full line of products available for your home improvement needs. Thank you for choosing Feit Electric!

Table of Contents

- Table of Contents 2
- Safety Information 2
- ISED STATEMENT 2
- Care and Maintenance 2
- Warranty 2
- Pre-Installation 3
- Tools Required 3
- Hardware Included 3
- Installation Preparation 3
- J-Box or Post Mount Installation 4
- Wiring Diagrams 5
- Troubleshooting 5
- Operation 6

DUSK TO DAWN OPERATION:

The light will turn on at dusk and remain on through the night until dawn. The light will remain off throughout the day, until dusk.

NOTICE: To make sure this function works properly, always keep the wall switch in the “ON” position (including daytime).

NOTICE: A sensor cover (DD) is provided which can be used to block out light and bypass the sensor. This will keep the light continuous on and fixture can be controlled to turn on/off through the wall switch or a master photocell.

Safety Information

For your safety, always remember to:

- Turn off the power supply at the fuse or circuit breaker box before you install the fixture.
- Ground the fixture to avoid potential electric shock and to ensure reliable starting.
- Double-check all connections to be sure they are tight and correct.
- Wear rubber soled shoes and work on a sturdy wooden ladder.
- Account for small parts and destroy packing material, as these may be hazardous to children.

This fixture is designed for use in a circuit protected by a fuse or circuit breaker. It is also designed to be installed in accordance with local electrical codes. If you are unsure about your wiring, consult a qualified electrician or local electrical inspector, and check your local electrical code.

Account for small parts and destroy packing material, as these may be hazardous to children.

Supplier’s Declaration of Conformity:
47 CFR § 2.1077 Compliance Information
Responsible Party:
Feit Electric Company
4901 Gregg Road,
Pico Rivera, CA 90660, USA
562-463-2852
Unique Identifier:
S13.5FL/MM/BZ

FCC STATEMENT: This device complies with part 15 of the FCC Rules. Operation is subject to the following two conditions: (1) This device may not cause harmful interference, and (2) this device must accept any interference received, including interference that may cause undesired operation. Note: This equipment has been tested and found to comply with the limits for a Class B digital device, pursuant to part 15 of the FCC Rules. These limits are designed to provide reasonable protection against harmful interference in a residential installation. This equipment generates, uses and can radiate radio frequency energy and, if not installed and used in accordance with the instructions, may cause harmful interference to radio communications. However, there is no guarantee that interference will not occur in a particular installation. If this equipment does cause harmful interference to radio or television reception, which can be determined by turning the equipment off and on, the user is encouraged to try to correct the interference by one or more of the following measures: Reorient or relocate the receiving antenna. Increase the separation between the equipment and receiver. Connect the equipment into an outlet on a circuit different from that to which the receiver is connected. Consult the dealer or an experienced radio/TV technician for help. Any changes or modifications not expressly approved by the manufacturer could void the user’s authority to operate the equipment. CAN ICES-005 (B)

This device complies with FCC radiation exposure limits set forth for an uncontrolled environment. This device should be installed and operated with a minimum distance of 20cm between the radiator and your body. Any changes or modifications not expressly approved by the manufacturer could void the user’s authority to operate the equipment.

Product Specifications:

- 120/277 VAC, 50/60Hz, 131W max
- Suitable for wet locations
- Dimmable with 0-10V dimmers only
- Suitable for mounting within 4 ft. (1.2 m) of the ground

 **WARNING: RISK OF SHOCK.** House electric current can cause painful shock or serious injury unless handled properly.

 **CAUTION:** Turn off the main power at the circuit breaker before installing the fixture, in order to prevent possible shock.

 **WARNING:** Changes or modifications to this unit not expressly approved by the party responsible for compliance could void the user’s authority to operate the equipment.

 **WARNING: RISK OF CUTS.** Some metal parts in the fixture may have sharp edges. To prevent cuts and scrapes, wear gloves when handling the parts.

NOTICE: All electrical connections must be in accordance with local and National Electrical Code (N.E.C.) standards. If you are unfamiliar with proper electrical wiring connections obtain the services of a qualified electrician.

Remove the fixture and the mounting package from the box and make sure that no parts are missing by referencing the illustrations on the installation instructions.

ISED STATEMENT

This device complies with Industry Canada’s license-exempt RSSs. Operation is subject to the following two conditions: (1) This device may not cause interference; and (2) This device must accept any interference, including interference that may cause undesired operation of the device.

Care and Maintenance

Periodically clean the fixture and diffuser using a mild, non-abrasive cleaner and soft cloth. When cleaning the fixture, make sure the power is turned off. Do not spray cleaner directly onto any part of the fixture or LEDs.

Limited Warranty

This product is warranted to be free from defects in workmanship and materials for up to 5 years from date of purchase. If the product fails within the warranty period, please contact Feit Electric at info@feit.com, visit feit.com/contact-us or call 1-866-326-BULB (2852) for instructions on replacement or refund. REPLACEMENT OR REFUND IS YOUR SOLE REMEDY. EXCEPT TO THE EXTENT PROHIBITED BY APPLICABLE LAW, ANY IMPLIED WARRANTIES ARE LIMITED IN DURATION TO THE DURATION OF THIS WARRANTY. LIABILITY FOR INCIDENTAL OR CONSEQUENTIAL DAMAGES IS HEREBY EXPRESSLY EXCLUDED. Some states and provinces do not allow the exclusion of incidental or consequential damages, so the above limitation or exclusion may not apply to you. This warranty gives you specific legal rights, and you may also have other rights which vary from state to state or province to province.

Pre-Installation

TOOLS REQUIRED (NOT INCLUDED)



Phillips
screwdriver

 **NOTE:** Hardware not shown to actual size.

HARDWARE INCLUDED

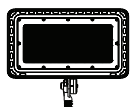

AA



BB



CC



DD

Part	Description	Quantity
AA	Single Head Commercial Security Flood Light	1
BB	Nut	1
CC	Wire Nuts	5
DD	Sensor Cover	1

Installation Preparation

- The fixture must be mounted using the Swivel Knuckle into a domed cover plate (not provided) on a junction box or via a landscape post (sold separately).

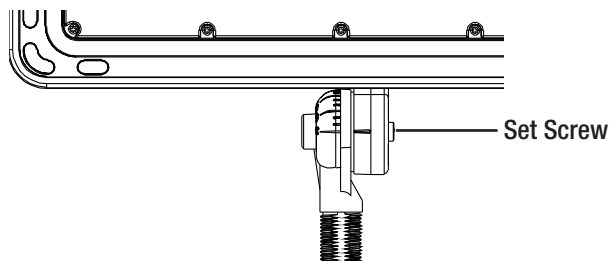

J-Box or Post Mount Installation

1 Turning Off the Power

- Turn the power OFF at the switch and fusebox or the circuit breaker.

2 Installing the Flood Light into the Weatherproof Cover or Landscape Post

- Install the fixture's swivel Knuckle extension with 1/2 in. thread into a weatherproof J-Box cover (sold separately) or landscape post (sold separately) for ground mount installation.

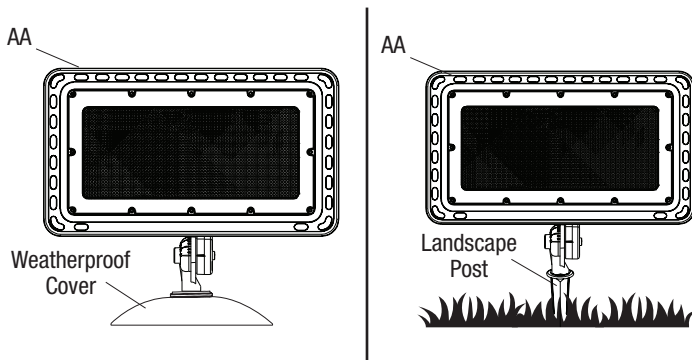

NOTE: Ensure the weatherproof J-Box cover and landscape post is provided with 1/2 in. threaded opening to install the fixture's swivel knuckle extension.

3 Connecting the Power Supply Wires

- Using the wire nuts (provided), connect the supply wires to the fixture's wires:
- See wiring diagram A or diagram B



NOTE: Purple and Pink wires to be used with 0-10V dimmers only (purple +10V, pink -10V). Purple (+10V) - Purple from dimmer Pink (-10V) - Pink from dimmer. See wiring diagram B

4 Securing the Fixture

- Mount the fixture onto the J-Box. Please ensure to follow the weatherproof cover or landscaping post manufacture installation instructions.

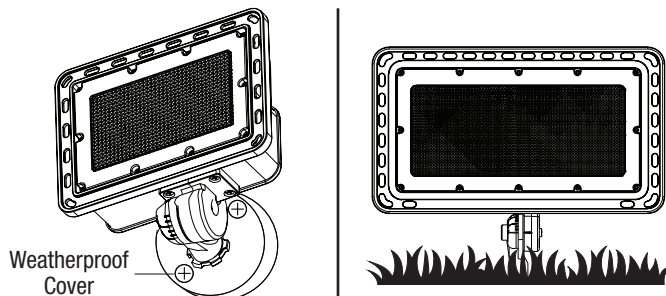

5 Tighten the Nut and Waterproof

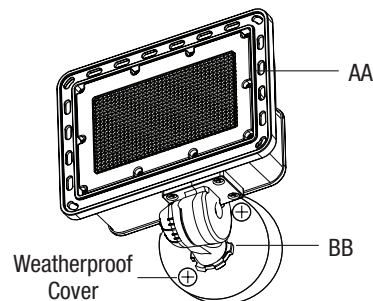

- Tighten the Nut (BB) on the Security Flood Light (AA) or landscape post (sold separately) for ground mount installation to secure it from moving.
- If water proof seals are not provided, to prevent water or moisture from entering the fixture between the fixture and mounting surface, waterproof silicon, caulk or gel should be applied to seal any gaps around the junction point.

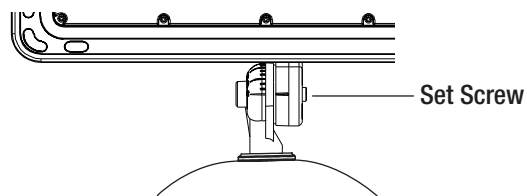

NOTE: To adjust the angle of the fixture, loosen the Set Screw of the swivel with screwdriver and position to a suitable angle and tighten the screw firmly.

6 Turning the Power On

- Turn the power ON at the wall switch, fusebox or the circuit breaker.

Wiring for a Standard Wall Switch

WIRING DIAGRAM A

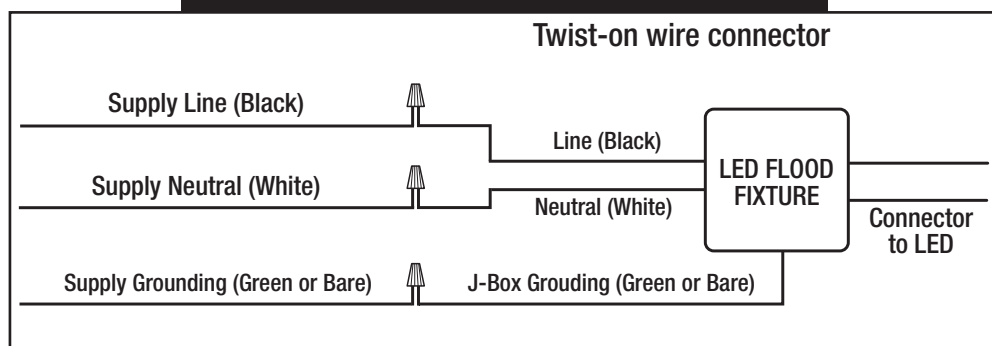

Wiring for 0-10V Dimmer

WIRING DIAGRAM B

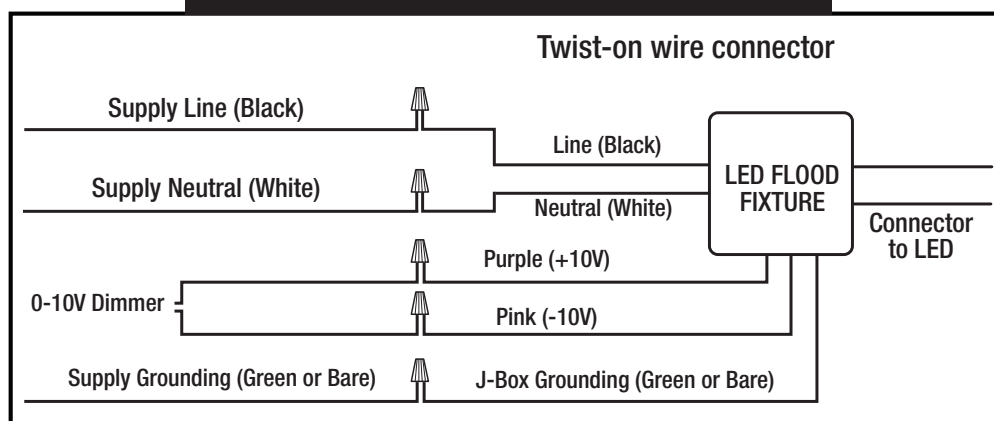

Troubleshooting

Problem	Possible Cause	Corrective Action
LED Flood light comes on during the day.	<ol style="list-style-type: none"> Dusk-to-Dawn sensor is in a shaded area and is fooled into thinking it is nighttime. Dusk-to-Dawn sensor is possibly dirty. 	<ol style="list-style-type: none"> Shine a flashlight onto the light sensor. If the security light turns off then the fixture is mounted in an area that does not allow enough light to enter the sensor. Relocate LED Wall Pack. Clean sensor with a damp soft cloth.
LED Flood light cycles ON and OFF continuously.	<ol style="list-style-type: none"> Dusk-to-Dawn sensor is sensing reflected light from the LED Wall Pack. 	<ol style="list-style-type: none"> Ensure no reflective materials are near to the wall pack. Relocate the LED Wall Pack to a different location where it no longer causes reflected light.
Light will not dim to 30%.	<ol style="list-style-type: none"> Switch is positioned in the D2D mode. 	<ol style="list-style-type: none"> Position switch to the MOT mode.

Operation

Lumen Switch

Select the brightness: 5000, 10,000, or 15,000 lumens

CCT Switch

Select the color temperature:

- 3K (3000K) – Soft White
- 3.5K (3500K) – Neutral White
- 4K (4000K) – Bright White
- 5K (5000K) – Daylight
- 6.5K (6500K) – Daylight Deluxe

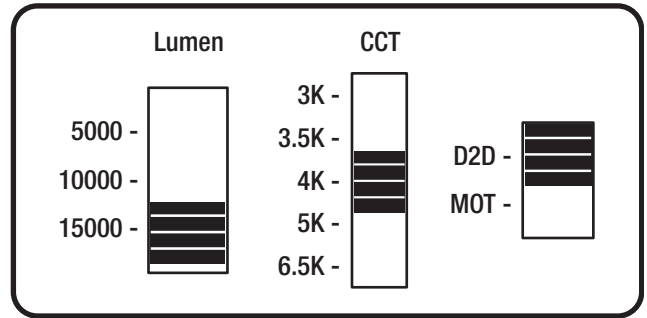

D2D/MOT Switch

D2D – Motion detection is disabled. Light will remain off during the day and automatically turn on at dusk.



NOTE: A Dust-To-Dawn Sensor Cover is provided to block out light and bypass the sensor. This will keep the light on continuously and the fixture can be controlled through the wall switch or a master photocell.

MOT – Motion sensor is activated. Light will turn on for 10 minutes when motion is detected. During this time, brightness will be at 100% and will drop to 30% of the selected lumen if no motion is detected.



NOTE: There will be a warmup time for about 10 seconds when first powered up. Brightness will be at 100% and will then drop to 30% after the warmup time. Brightness will go to 100% once motion is detected.



NOTE: The 180-degree coverage of the motion sensor is measured side-to-side. The sensor will detect motion across the field of view (see below image). The motion sensor maximum detection range is up to 50 ft.

Motion Detection Distance at Mounting Heights:

8ft: Maximum detection range is up to 55ft.

15ft: Maximum detection range is up to 45ft.

20ft: Maximum detection range is up to 40ft

