

INSTRUCTION MANUAL

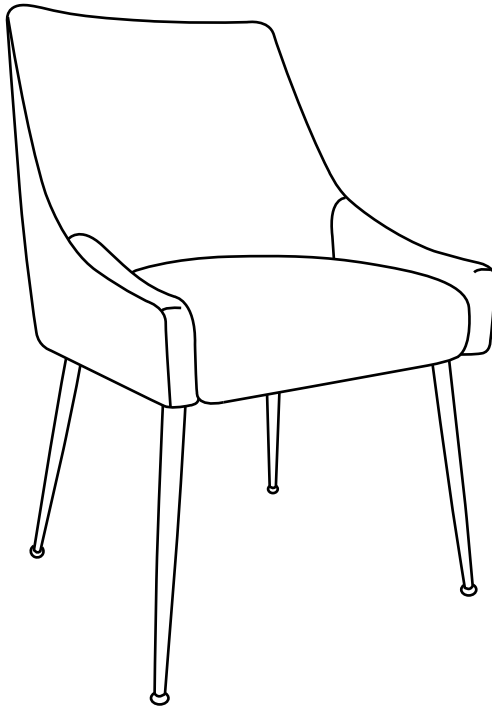

**Upholstered Performance Velvet
Accent Chair With Metal Leg
SKU: IA4002**

V1.0

! CARE & MAINTENANCE

Please keep this instruction for your future reference.

- Be careful when assembly, avoid hurting the plating of the surface.
- Clean the chair with lukewarm water, mild detergent & soft cloth.
- Firmly secure all bolts before use, do not use any part of this item as a step ladder.
- Reconfirm that all bolts, screws, and nuts are secure every 90 days.
- Do not use or store this item in the proximity of open flame or flammable/combustible chemicals.
- Be aware that some parts are heavy and have sharp edges.
- Do not overtighten screws. (Insert all screws before tighten screws.)

TOOLS REQUIRED



ALLEN WRENCH
(PROVIDED)



250 LBS
CAPACITY



1 PERSON
ASSEMBLY



UP TO 15 MIN.
ASSEMBLY

HARDWARE

1

BOLT



12 PCS

2

WRENCH



1 PC

PARTS

A

CHAIR BODY

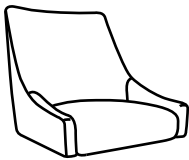

1 PC

B

FRONT LEG

with adjustable feet leveler
(metal gold)

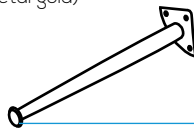

2 PCS

adjustable feet leveler

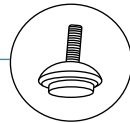

C

BACK LEG

with adjustable feet leveler
(metal gold)

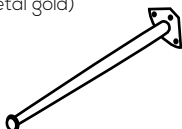

2 PCS

adjustable feet leveler

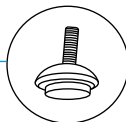

PRODUCT ASSEMBLY

1

Attach 2pcs of Part B Front Legs & 2pcs of Part C Back Legs to Part A Chair Body with 12 pcs Hardware 1 Bolt

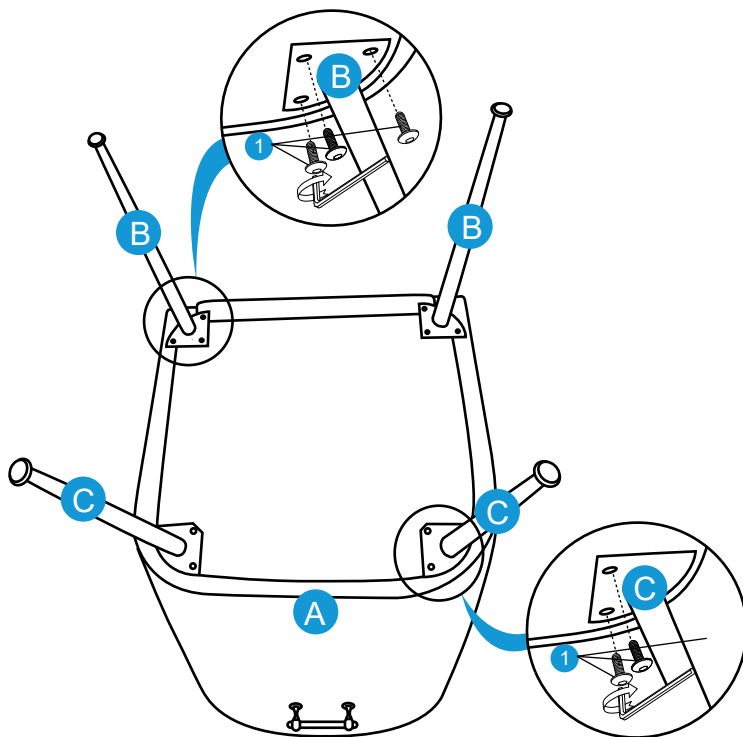

2

Tighten all the bolts again to ensure the chair is stable enough to use. Adjust the feet levelers for perfect balance.

