







ASSEMBLY INSTRUCTIONS

Palone Shelving Wood/Metal 24"

<p>X4+1 EXTRA</p>  <p>SCREWS</p>	<p>X1</p>  <p>ALLEN KEY</p>	<p>X2+1 EXTRA</p>  <p>WALL ANCHOR</p> <p>X2+1 EXTRA</p>  <p>SCREWS</p>	 <p>1 PC WOODEN SHELF</p>	 <p>2 PCS METAL BRACKET</p>
---	--	--	---	--

STEP-1

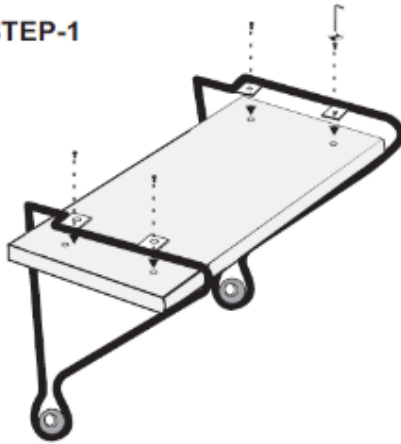

Place the metal brackets on wooden shelf as shown and secure with help of Allen screws.

STEP-2

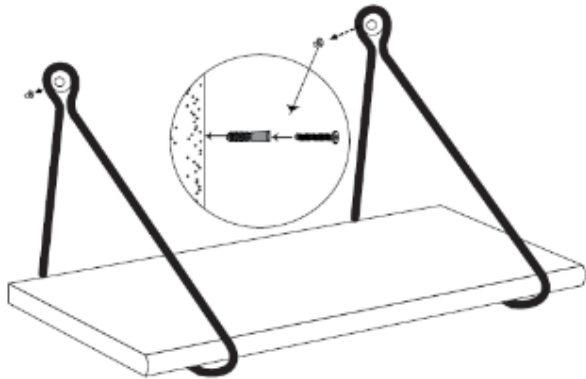

After fixing the anchors in to the wall-mount the shelf as shown and secure with screws.

READY TO USE

