





Thank you for purchasing this quality product. Be sure to unpack carefully looking for small parts which may have come loose during shipment.

Read all instruction and study the drawing carefully before starting the assembly process.

PART LIST			
NO.	DRAWING	DESCRIPTION	Q'TY
①		Feet	3 PCS
②		Shelf Panel	2 PCS
③		Post	3 PCS
④		Cap	3 PCS

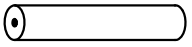

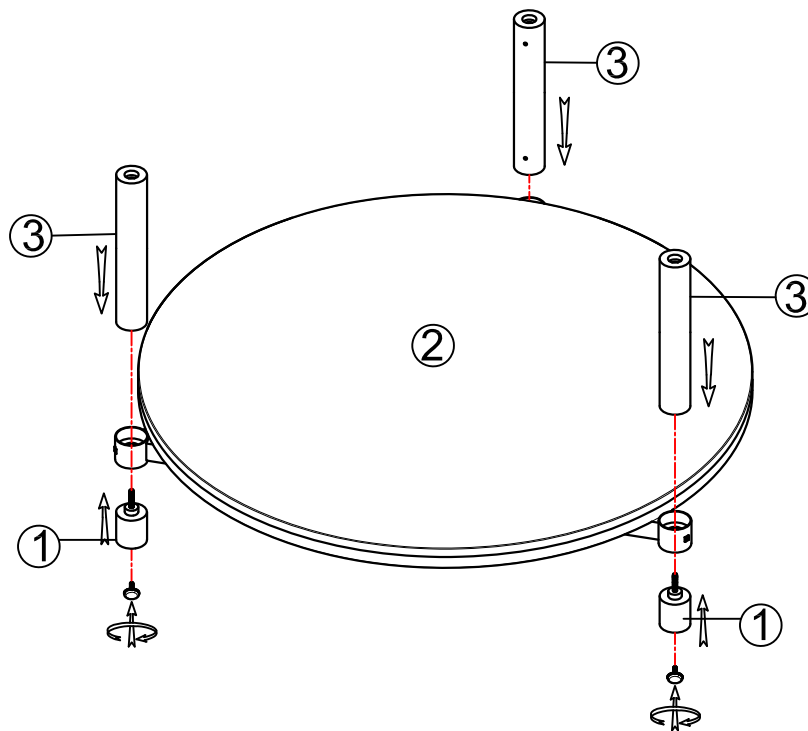
**STEP 1:**  
Assemble feet (1), shelf panel (2) and post (3).

Thank you for purchasing this quality product. Be sure to unpack carefully looking for small parts which may have come loose during shipment.

Read all instruction and study the drawing carefully before starting the assembly process.

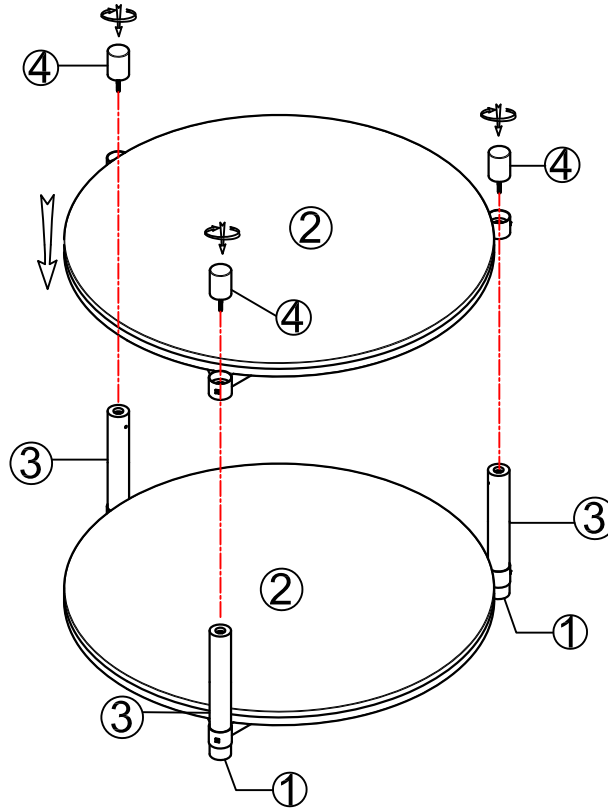
**STEP 2:**

Assemble cap (4) and shelf panel (2),  
attach shelf panel (2) to the post (3).

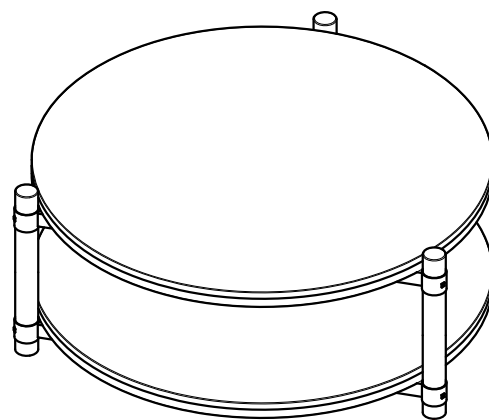
**STEP 3:**

Adjust leveler if needed to level table  
on uneven floor.

