

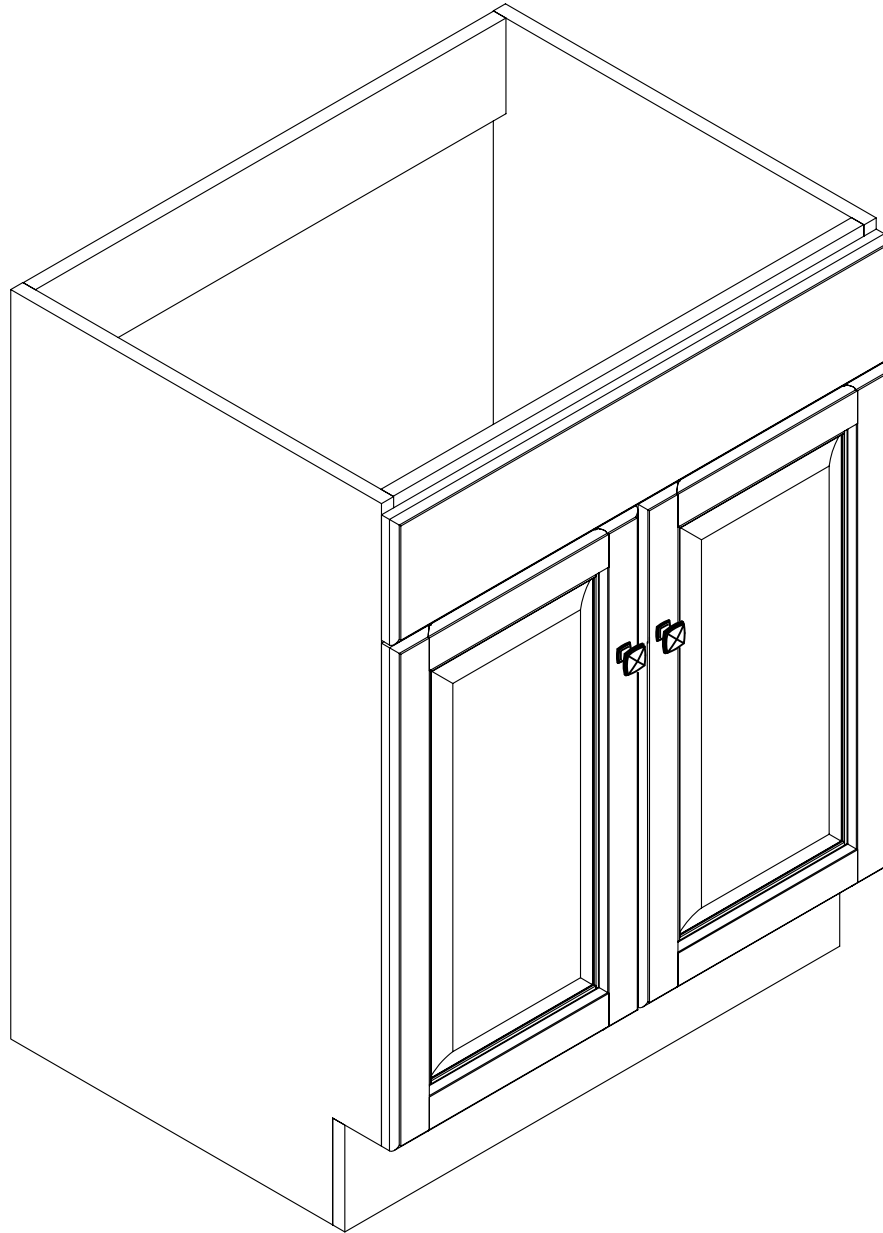

www.todaysdesignhouse.com



591107

ASSEMBLY INSTRUCTIONS

DHI Corp. • 5205 W. Donges Bay Rd. • Mequon, WI 53092 • 800.558.8700

PARTS LIST:

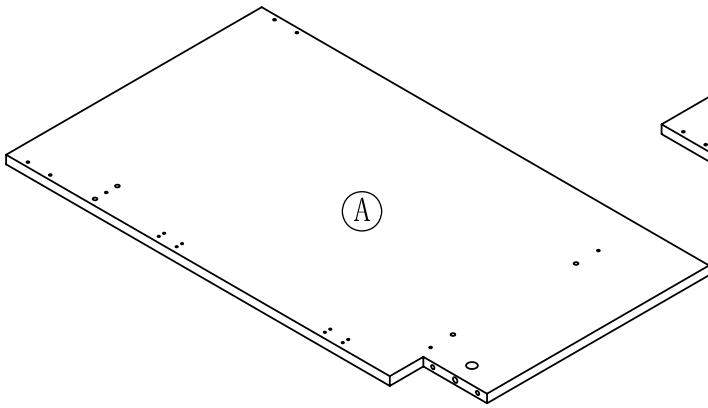

LEFT SIDE PANEL 1PC

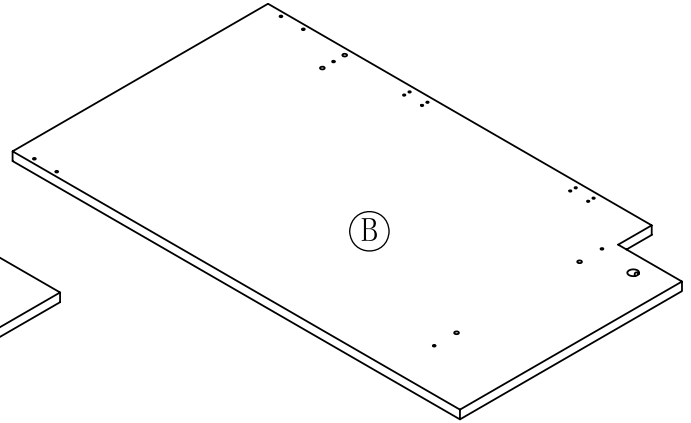

RIGHT SIDE PANEL 1PC

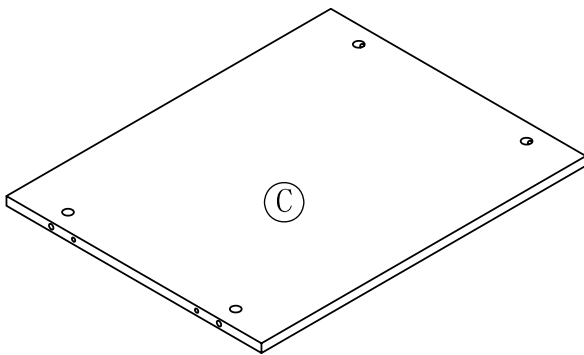

BOTTOM PANEL 1PC

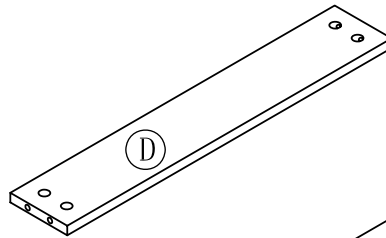

BACK CROSS BRACE 1PC

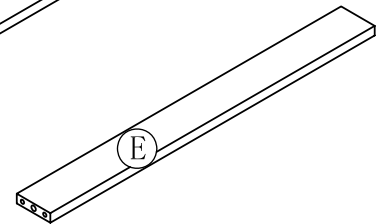

FRONT CROSS BRACE 1PC

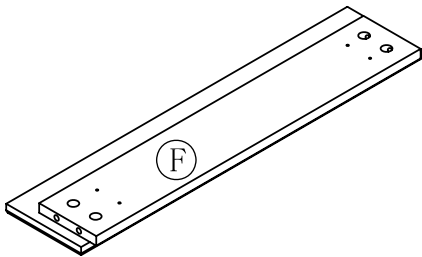

FALSE DRAWER FRONT 1PC

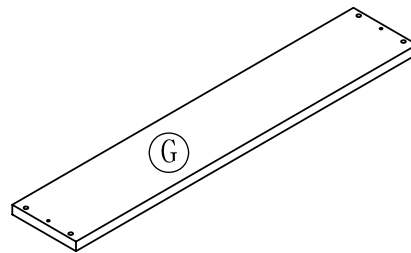

TOE KICK PANEL 1PC

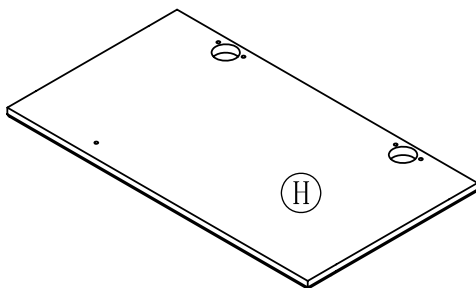

LEFT SIDE DOOR 1PC

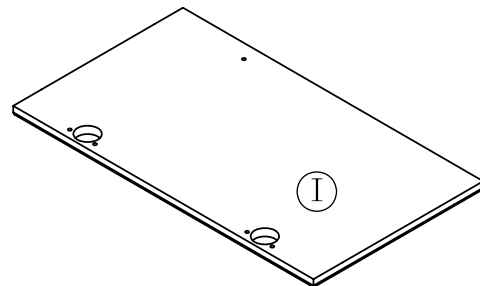

RIGET SIDE DOOR 1PC

HARDWARE LIST:



a. WOOD DOWEL 12PCS

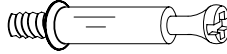

b. CAM LOCK SCREW 16PCS

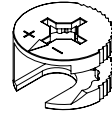

c. CAM LOCK 16PCS

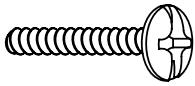

d. KNOB BOLT 2PCS

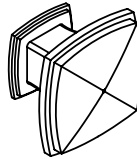

e. KNOB 2PCS

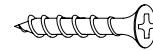

f. 5/8" L FLAT HEAD SCREW 24PCS

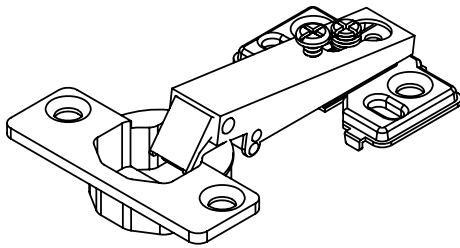

g. HINGE 4PCS



h. WRENCH 1PC

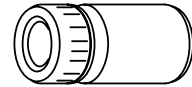

i. GLUE 1PC

STEP 1

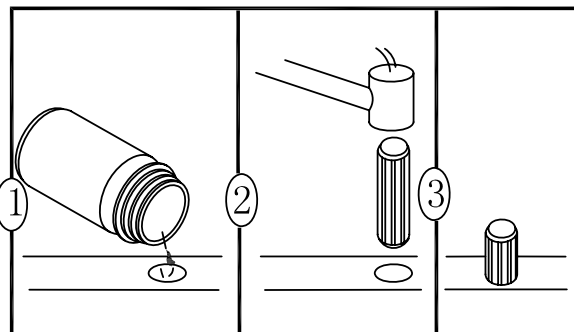
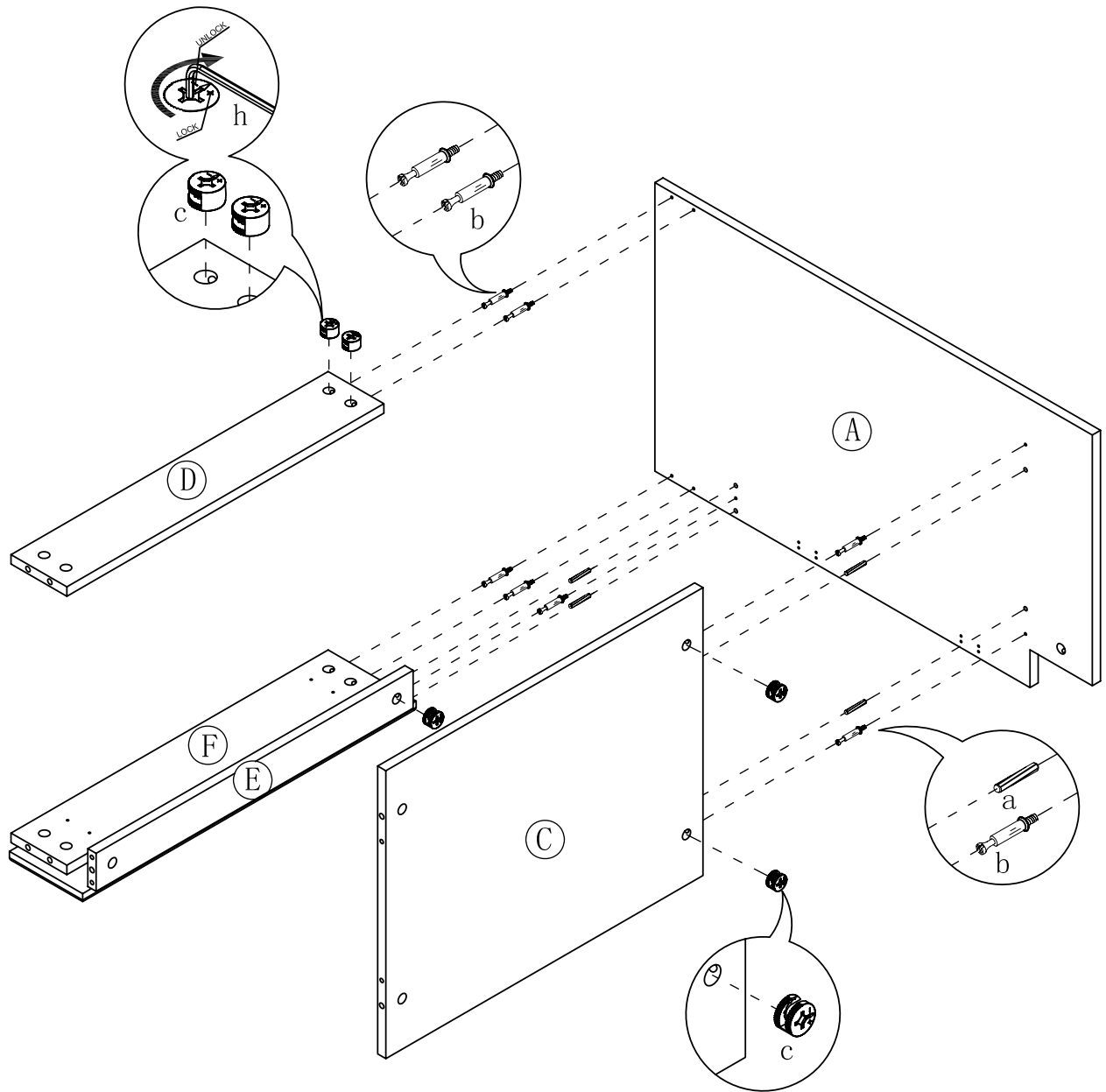

STEP 2

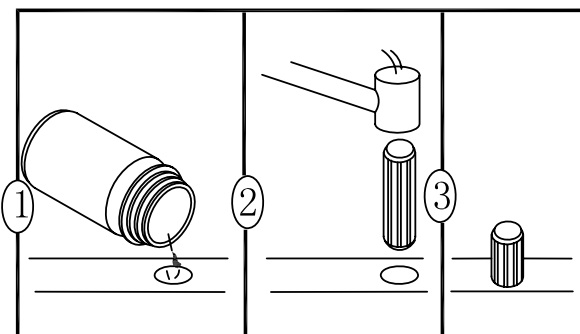
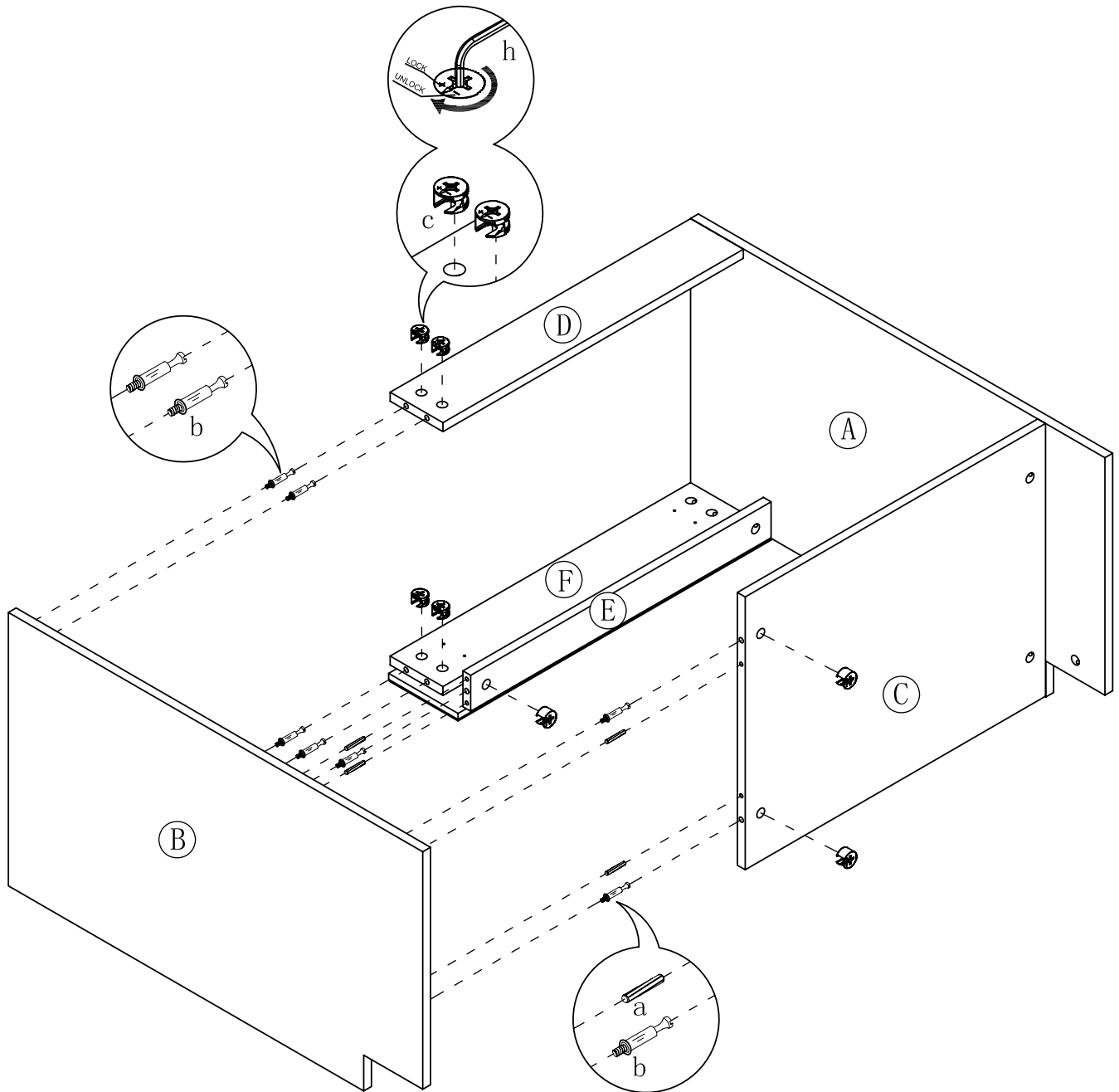

STEP 3

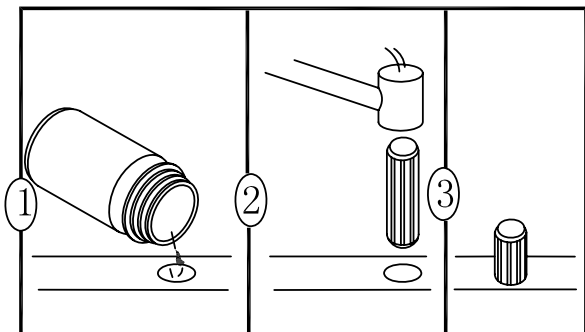
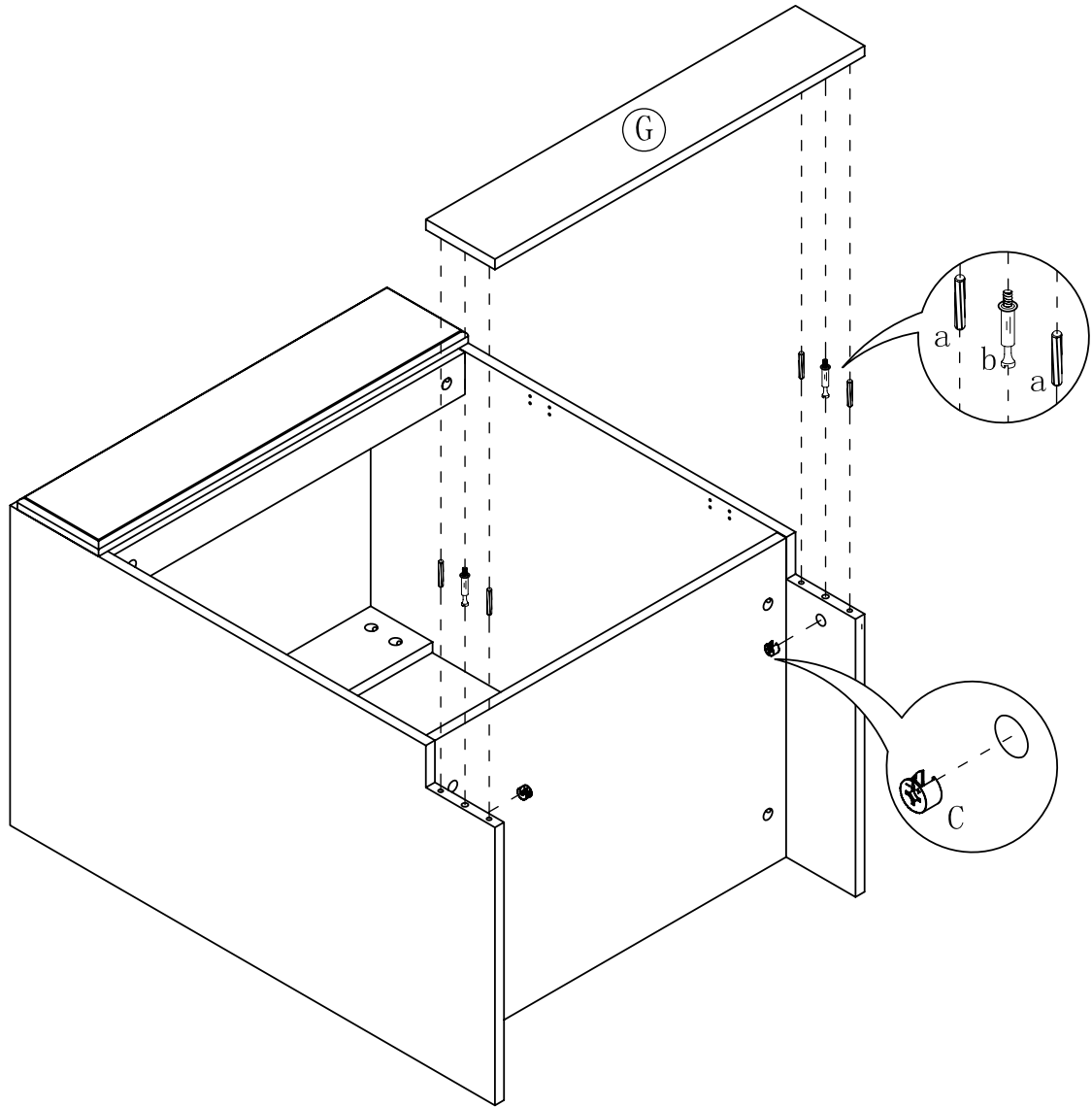

STEP 4

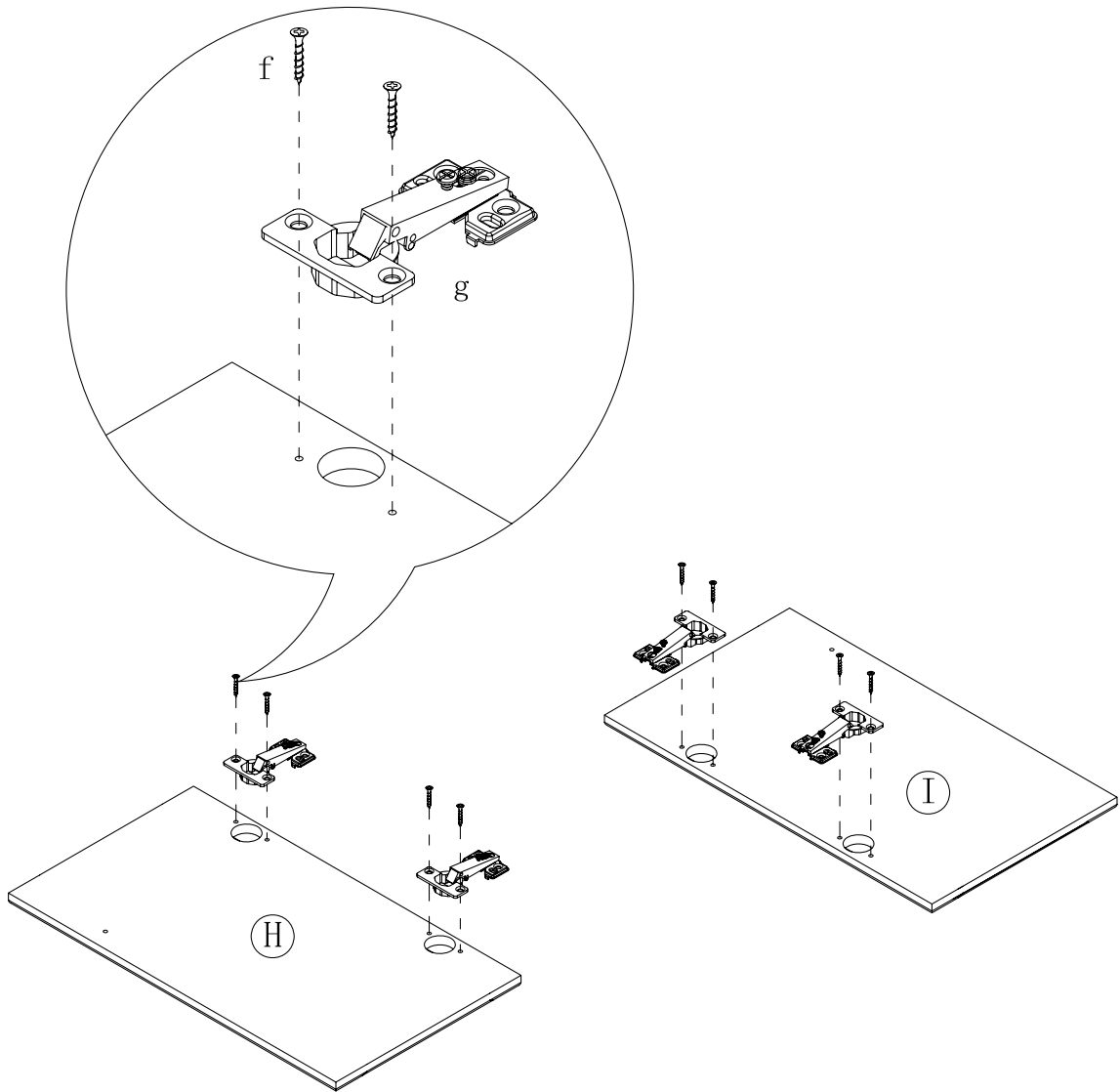

STEP 5

