

# TelaScapes FABRIC TRACK SYSTEM

## INSTALLATION MANUAL

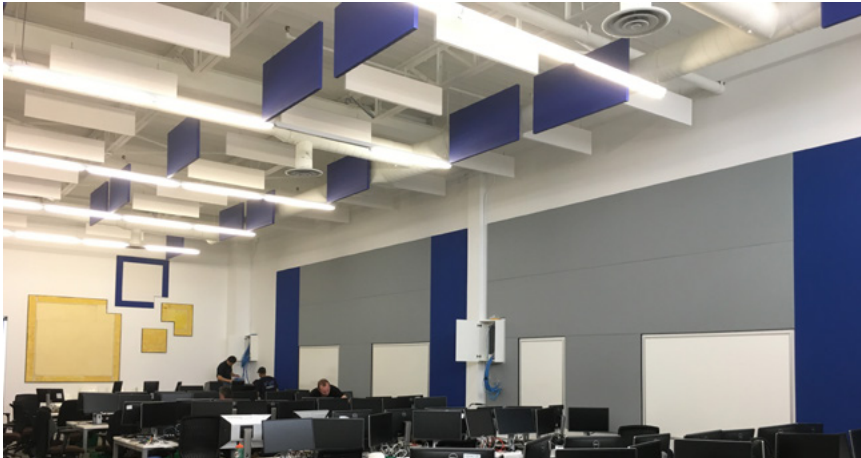

Thank you for your purchase of the Primacoustic TelaScapes Fabric Track System. This product is ideal for large spaces where a custom color or pattern is needed.

The TelaScapes Fabric Track System allows you to acoustically treat any commercial or residential space without sacrificing aesthetics, while maintaining a high level of effective sound absorption within the space. The system is comprised of three fully customizable components: high density glass wool panels that provide broadband acoustic absorption, a modular track system that is almost universally compatible with any surface, and a selection of stretch fabric available in a wide range of colors or in a printable option to apply unique graphics and logos.

Please take a few minutes to read through this manual before you begin installing TelaScapes. Should you have any questions or comments, please feel free to contact us by email at [info@primacoustic.com](mailto:info@primacoustic.com) for a timely response.

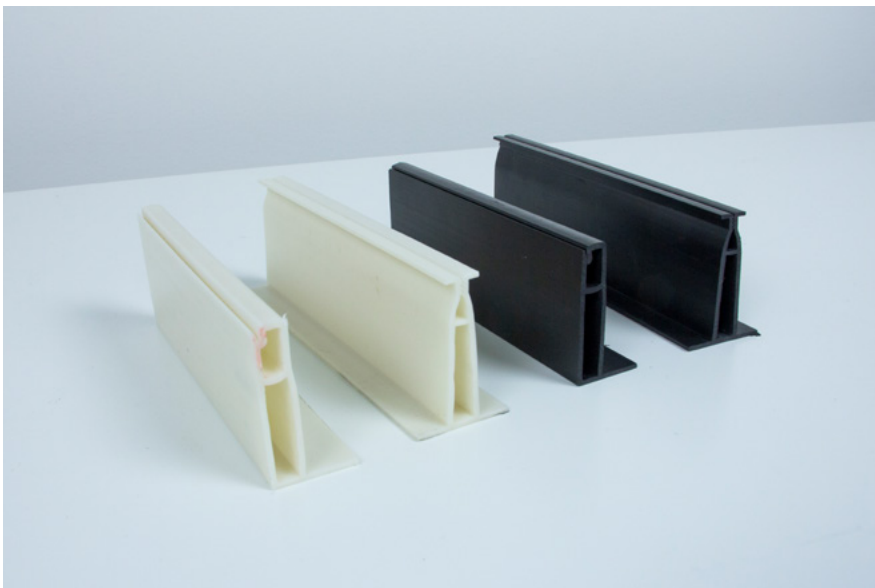

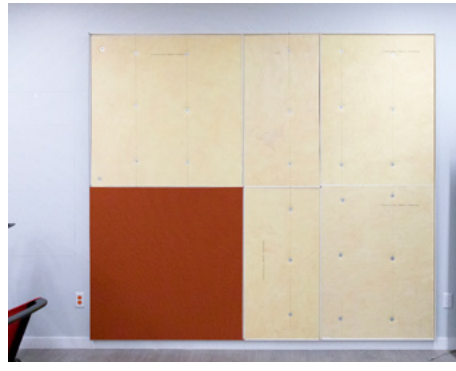

## TOOLS REQUIRED

- Utility Knife
- Scissors
- Sandpaper and/or File

5" Finishing Spatula

2" Finishing Spatula



TelaRocker

## Fabric Tucking Tools (available from Primacoustic)

- TelaRocker
- 5" Finishing Spatula
- 2" Finishing Spatula

## Track Cutting

- 8" or 10" Miter Saw
- Saw Blade should be "Ultra Thin" for cutting plastic, with 200 teeth per blade. Do not use a carbide tip saw blade, use a plywood blade.



## Track Attachment

- For attaching to drywall we recommend an 18 Ga. 1/4" Crown Stapler
- If a stapler is not available the track can be screwed through the drywall into blocking, using pan head sheet metal screws every 1"-2" max.
- For attaching track to surfaces other than drywall your tool requirements will vary.

## Panel Attachment

- Appropriate length drywall screws depending on track and panel thickness
- Panel securing washers available through Primacoustic.



Schluter galvanized steel washers.  
(pack of 100)

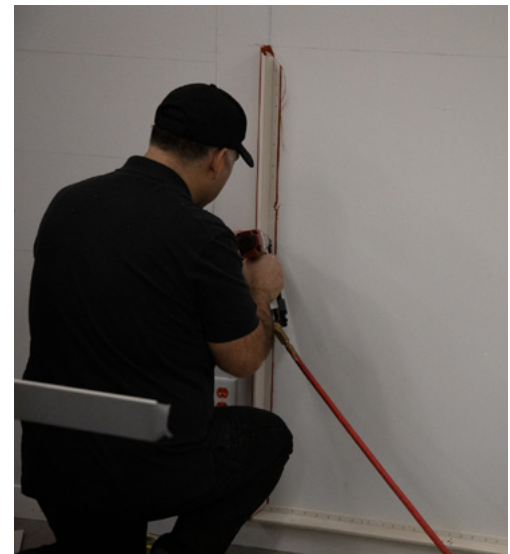

## PLAN THE SPACE

It's best to first draw out and plan how you want to design your TelaScapes and have a plan for each section. Begin by striking the outer perimeter of the wall using a laser or level and tape measure.

After the outer perimeter has been marked, mark the mid-wall tracks that will be required to complete the design.

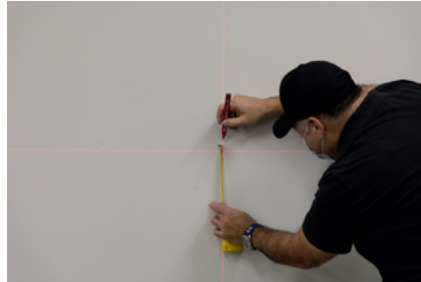
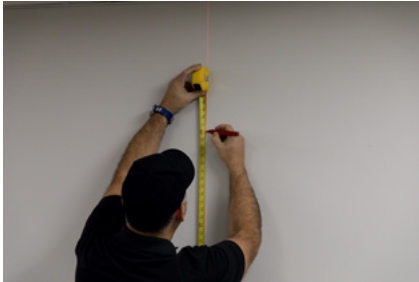
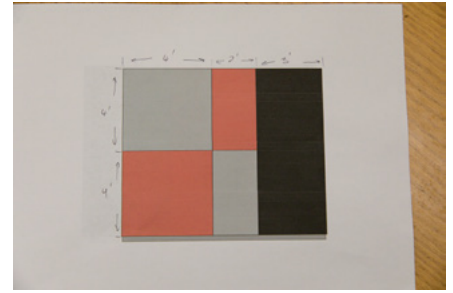

## CUTTING THE WALLTRACK

After the plan has been laid out on the wall, its time to start cutting the tracks to match the design. A miter saw is required to make the angle cuts for the corners and joints for the perimeter and mid-wall tracks.

For the perimeter, measure each track that will be going the length of one section. For each corner, the appropriate angle cut must be made to make the joint look seamless. For squares a 45° angle will need to be cut, however any other shape and angle can be done. Just note the angle to ensure that all joints are connected tightly.

The Mid-wall track requires two 45° miter cuts to fit between two tracks.

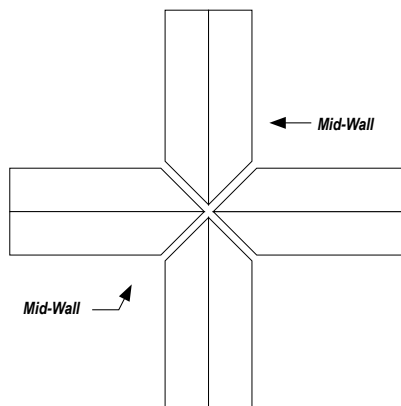
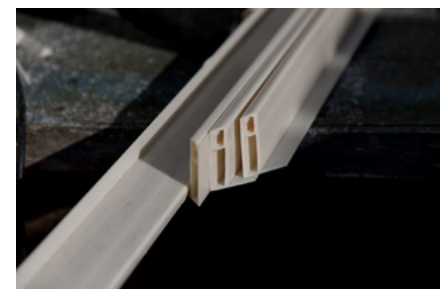
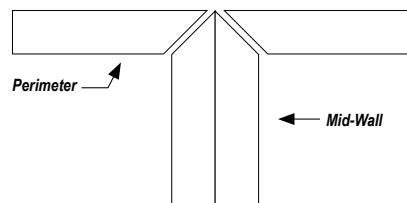
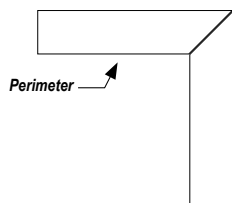

Joining mid-wall tracks require all 4 points to be mitered to a triangle.

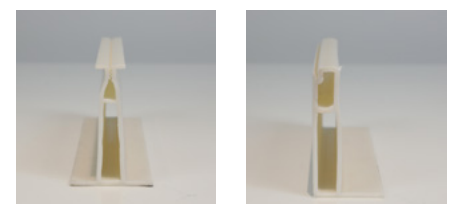

Mid-Wall

Perimeter

## PRE-WRAP

Before attaching the outer perimeter track to the wall, you must first pre-wrap the outer tracks with fabric to create the seamless design between track and wrapped fabric.

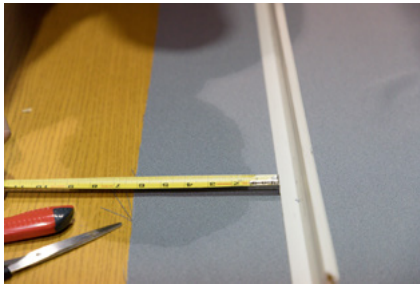
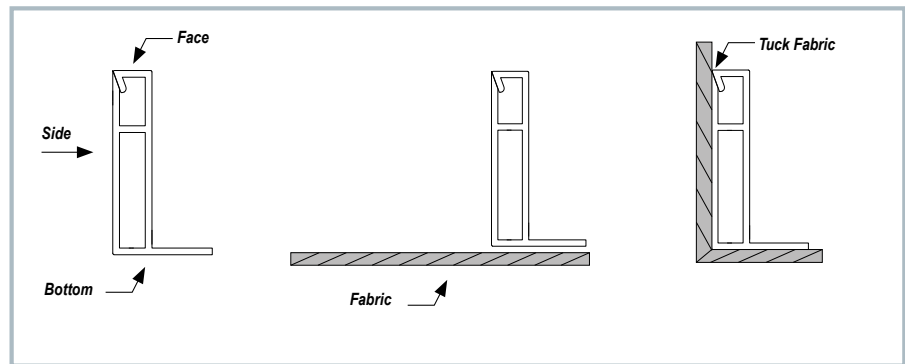

1. Begin by cutting a strip of fabric to attach to the perimeter track. A 6" strip is recommended for a 2" frame and a 4" strip is best for the 1" frame.



2. Carefully cut a straight edge to have a piece of fabric to attach the track.



3. Spray adhesive to the side and bottom of the track. On a flat surface, lay the track down onto the fabric with the bottom face.



4. Wrap the track with the fabric strip on the bottom and side edge. Tuck in the excess fabric into the channel.



5. Trim the excess fabric.



6. Re-tuck the excess fabric back into the channel to create a clean line.



A finished perimeter track is now ready to be mounted to the wall.



## MOUNTING THE TRACKS

Now that the perimeter tracks have been pre-wrapped it is time to mount the track system on the wall. Start with a perimeter corner track and attach using staples or screws every 1" - 2" and shot at different angles to best affix the track onto the drywall. Each connecting perimeter track should be placed flush and without gaps to each other.

Perimeter tracks with an expected mid-wall track connection should leave 1/16" spacing to allow for extra fabric and material.

Mid-wall tracks should be then placed in a similar fashion with staples or screws every 1" - 2", alternating sides of the track to secure properly.

When a 4 mid-wall tracks are coming to a point, leave 1/16" gap between each track to allow for fabric.

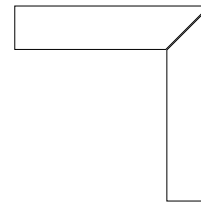

*Perimeter tracks should be mounted flush to each other.*

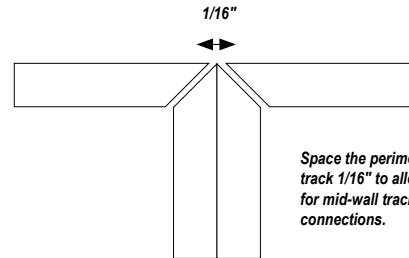

*Space the perimeter track 1/16" to allow for mid-wall track connections.*

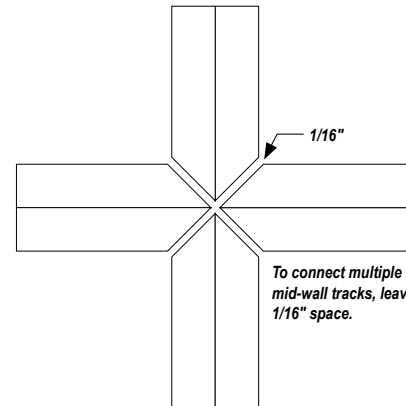

*To connect multiple mid-wall tracks, leave 1/16" space.*



## PREPARING THE ACOUSTIC MATERIAL



1. Prepare the acoustic material by first cutting to size for each section.



2. It is recommended to re-seal the exposed edge with an adhesive to prevent any glass wool from escaping.



3. Fit the acoustic panel into the frame, ideally it should be tight and hold in place on its own.



4. It is recommended to mark out stud locations and transfer to the panel to mark where to secure the panels with the mounting hardware.



5. Secure the panel to the wall using an appropriate length drywall screw and washers. Washers are available from Primacoustic.

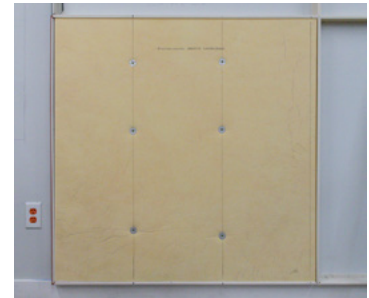

6. Panel is now secured in place and is ready to be fabric wrapped.



*Schluter galvanized steel washers.  
(pack of 100)*

## STRETCHING THE FABRIC



1. Measure and cut the fabric to the first section. Cut 6-8" wider and longer than the area to be covered. Take note of patterns and textures that should be straight with the panel.



2. Start at the top of the center of the track and tuck the fabric in both directions. There should be 2-3" of extra fabric, leave this to be trimmed later.



3. Now tuck the bottom of the panel starting at the center and working your way to the edges.



4. Tuck the sides of the panel starting at the middle and working your way out, alternating on each side. Take care in the corners to ensure they will not rip.



5. After all edges are tucked, double check the pattern and weave to make sure they are in the correct orientation.



6. Use scissors to trim the edge of the fabric as close to the track as possible, be careful not to also cut the trucked fabric.



7. Tuck in the remaining fabric into the track to hide the recently trimmed fabric. Again take extra precaution tucking in at the corners.



8. Trim any loose threads and you now have a finished TelaScapes Panel.



9. Repeat these steps for the remaining sections.

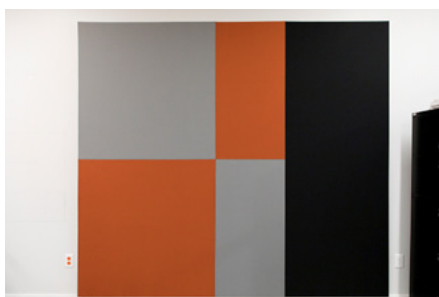
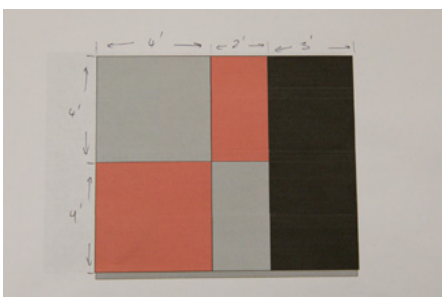

From design to final installation, TelaScapes makes creating a custom acoustic solution easy.

## WARRANTY

Please inspect products immediately after receiving your purchase. Primacoustic acoustic products are guaranteed to be free of manufacturing defects for a period of 3 years after purchase. In the unlikely event that a defect is uncovered, please call 604-942-1001 to obtain a RA number (Return Authorization number) from Primacoustic before the 3 year warranty period expires. Once you have obtained a RA number you must return the product, freight prepaid, within fifteen (15) days after the date the RA number is issued. Please return the product in the original packaging (or another, affording an equal degree of protection) with all of the following: (1) RA number clearly marked on the returned package; (2) a receipt or bill of sale showing proof of purchase from an authorized seller; plus (3) a letter describing the defect. Please include your name, address, telephone number and the applicable RA number. You are solely responsible for all shipping and insurance costs for returning the product to Primacoustic, and you will not be reimbursed or compensated for any loss or damage incurred during return shipping. Primacoustic will at its sole discretion repair or replace the product. Should the product no longer be available, Primacoustic reserves the right to exchange this with a product of similar performance and value. Due to different dye lots, Primacoustic cannot guarantee exact color match. This Warranty shall solely extend to the original owner and is limited to manufacturing defects and excludes damage due to improper installation, freight handling, wear and tear, abuse, misuse, misapplication, color fading or deterioration due to prolonged exposure to ultra violet light, smoke, humidity or other environmental factors. It is understood that the use and suitability of the product is entirely the responsibility of the buyer or specifying engineer and as such, these parties agree to hold Primacoustic, or its associated company, and/or officers, harmless from any responsibility whatsoever other than what is clearly outlined in this warranty.

## SPECIFICATIONS

CORE MATERIAL	Formed, semi rigid inorganic glass fibers; Density = 6.0 lbs. (2.72kg/m3) per cubic foot
---------------	------------------------------------------------------------------------------------------

