

USER'S MANUAL

UBAC50D

AMPLIFIED | 12V UNIVERSAL **BLUETOOTH**® CONTROLLER
AMPLIFICADO | 12V UNIVERSAL CONTROLADOR DE **BLUETOOTH**®



BOSS Audio Systems
3451 Lunar Court • Oxnard, CA 93030
www.bossaudio.com | 805.322.8794
tech support: www.bossaudio.com/support/technical-support



0816



The Bluetooth® word mark and logos are registered trademarks owned by Bluetooth SIG, Inc. and any use of such marks by BOSS Audio Systems is under license. Other trademarks and trade names are those of their respective owners.

Las marcas registradas marca Bluetooth® y sus logotipos son marcas registradas propiedad de Bluetooth SIG, Inc. y cualquier uso de dichas marcas por parte de BOSS Audio Systems es bajo licencia. Otras marcas y nombres comerciales pertenecen a sus respectivos propietarios.

USER'S MANUAL

UBAC50D

AMPLIFIED | 12V UNIVERSAL **BLUETOOTH**® CONTROLLER
FEATURING BUILT-IN CLASS D AMPLIFIER

AMPLIFICADO | 12V UNIVERSAL CONTROLADOR
DE **BLUETOOTH**®
AMPLIFICADOR DE CLASE D INCORPORADO



TABLE OF CONTENTS

INTRODUCTION	1
WHAT'S IN THE BOX	2
IMPORTANT SAFETY PRECAUTIONS	3
INSTALLATION PRECAUTIONS	4
WIRING	5
MOUNTING METHODS	6
GETTING TO KNOW YOUR UBAC50D	7
BLUETOOTH OPERATION	8
BLUETOOTH RECONNECTION	10
BLUETOOTH STREAMING CONTROL	11
AUX-IN	12
TROUBLE SHOOTING	13
SPECIFICATIONS	13

All trademarks are the property of their respective owners.
BOSS AUDIO SYSTEM has no affiliation with these companies.

All rights reserved. No part of this publication may be reproduced, distributed, or transmitted in any form or by any means, including photocopying, recording, or other electronic or mechanical methods, without the prior written permission of BOSS AUDIO INC.

Copyright © 2016 BOSS AUDIO INC

Congratulations
on your new purchase of the

BOSS[®]
AUDIO SYSTEMS

UBAC50D

The *UBAC50D* is a universal
Bluetooth[®] audio source unit controller
with integrated 2CH *Class D* amplifier. Designed for
Android / iOS / Windows Smart devices.

The *UBAC50D* conveniently expands your existing
sound system from one small package. Rear RCA
outputs connect direct to your larger amplifiers for
extending your system. You can easily control your
favorite music streaming *APP* all whilst keeping
your device safely stored away.

Other conveniences include a front *3.5mm AUX
INPUT* port and *USB* charging port for keeping your
Smart Devices battery topped off.
(USB and AUX cables not included)

Please read through these instructions carefully so you will
know how to operate your model properly. After you have
finished reading the instructions, keep this document in a
safe place for future reference.

INTRODUCTION



The Bluetooth® word mark and logos are registered trademarks owned by Bluetooth SIG, Inc. and any use of such marks is under license. Other trademarks and trade names are those of their respective owners.

FCC COMPLIANCE STATEMENT

This device complies with part 15 of the FCC Rules. Operation is subject to the following two conditions:

- (1) this device may not cause interference, and
- (2) this device must accept any interference, including interference that may cause undesired operation of this device.

This transmitter must not be co-located or operated in conjunction with any other antenna or transmitter. The Bluetooth antenna cannot be removed (or replaced) by user. This equipment complies with FCC/ IC radiation exposure limits set forth for an uncontrolled environment and meets the FCC radio frequency (RF) Exposure Guidelines and RSS-102 of the IC radio frequency (RF) Exposure rules. This equipment has very low levels of RF energy that it deemed to comply without maximum permissive exposure evaluation (MPE). But it is desirable that it should be installed and operated keeping the radiator at least 20 cm or more away from person's body (excluding extremities: hands, wrists, feet and ankles). Alteration or modifications carried out without appropriate authorization may invalidate the user's right to operate the equipment.

NOTE: This equipment has been tested and found to comply with the limits for a Class B digital device, pursuant to Part 15 of the FCC Rules. These limits are designed to provide reasonable protection against harmful interference in a residential installation. This equipment generates, uses and can radiate radio frequency energy and, if not installed and used in accordance with the instructions, may cause harmful interference to radio communications. However, there is no guarantee that interference will not occur in a particular installation. If this equipment does cause harmful interference to radio or television reception, which can be determined by turning the equipment off and on, the user is encouraged to try to correct the interference by one or more of the following measures:

- Relocate or reorient the receiving antenna.
- Increase the separation between the equipment and receiver.
- Connect the equipment into an outlet on a circuit different from that to which the receiver is connected.
- Consult the dealer or an experienced radio/TV technician for help.

CAUTION!!

ADJUSTMENT OR ALTERATIONS OF THIS DEVICE MAY RESULT
IN HAZARDOUS RADIATION EXPOSURE.

WHAT'S IN THE BOX

UBAC50D

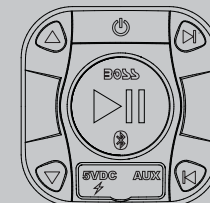

SURFACE & FLUSH MOUNT BEZELS

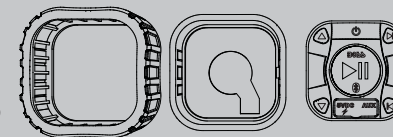

BAR MULTI-MOUNT

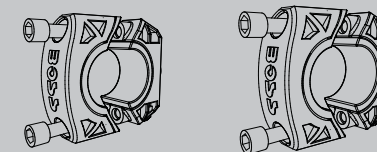

0.75" ~ 1"

1.5" ~ 2.00"

HANDLEBAR & CAGE BUSHINGS



4mm Allen Head

QUICK START GUIDE

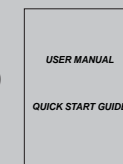

WARRANTY CARD



FACEBOOK CARD

IMPORTANT SAFETY PRECAUTIONS

EN

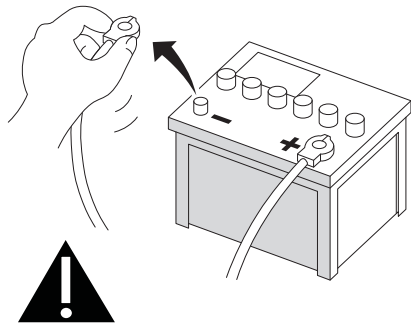

To avoid potential shorts in the electrical system, be sure to disconnect the (-) battery cable before installation. Use this unit with a 12-volt battery and negative grounding system only. Failure to do so may result in a fire or malfunction.

- Do not operate mobile equipment while driving a motorized vehicle – safe driving and safety consideration of others should always be your highest priority.
- In the event you should notice smoke, strange noises or odor from this product, or any other abnormal signs, immediately turn off the power and consult your dealer or the nearest authorized **BOSS AUDIO Service Center**. Using this product in this condition may result in permanent damage to the system.
- Refer any repairs to a qualified **BOSS AUDIO SYSTEMS Service Center**.
- Set your volume control at a low setting, then slowly increase the sound until you can hear it comfortably without distortion, or ear discomfort.

BE SURE TO OBSERVE THE FOLLOWING GUIDELINES:

- Do not turn up the volume so high that you can't hear what's around you.
- Use caution or temporarily discontinue use in potentially hazardous situations.
- Abide all Federal, State, and Local laws.

3

BOSS[®]
AUDIO SYSTEMS

INSTALLATION PRECAUTIONS

WARNING - Always consult a professional installer

- Do not attempt to install or service this product by yourself. Installation or servicing of this product by persons without professional training and experience in electronic equipment and motorized vehicle accessories may be dangerous and could expose you to the risk of electric shock, injury or other hazards.
- Ensure the **UBAC50D** is not attached to, or behind metal.
- Never install this product in a heated location, or under water.
- Do not install the **UBAC50D** next to the vehicles electronics.
- The **UBAC50D** should be hard wired directly to an accessory switch or to the battery through an optional switched relay.
- Always use the included fuse and fuse holder, always replace with a 3 Amp fuse.
- The **UBAC50D** has a weather resistant design, it should not be under any circumstances submerged in, or under water.
- Use only the supplied installation parts provided with the **UBAC50D**.
- Wash with a mild detergent and lukewarm water using a clean sponge or a soft cloth.
- Rinse well with clean water.

"DO NOT'S" - Very Important

- DON'T clean in hot sun or on very hot days.
- DON'T use abrasive or highly alkaline cleaners on the main body.
- DON'T scrape the main body with razor blades, or other sharp instruments.
- DON'T ever use, gasoline, acetone or carbon tetrachloride.
- DON'T ever use a pressure washer.

4

BOSS[®]
AUDIO SYSTEMS

EN

EN

QUICK START GUIDE

WIRING

TECH SUPPORT: 805.322.8794

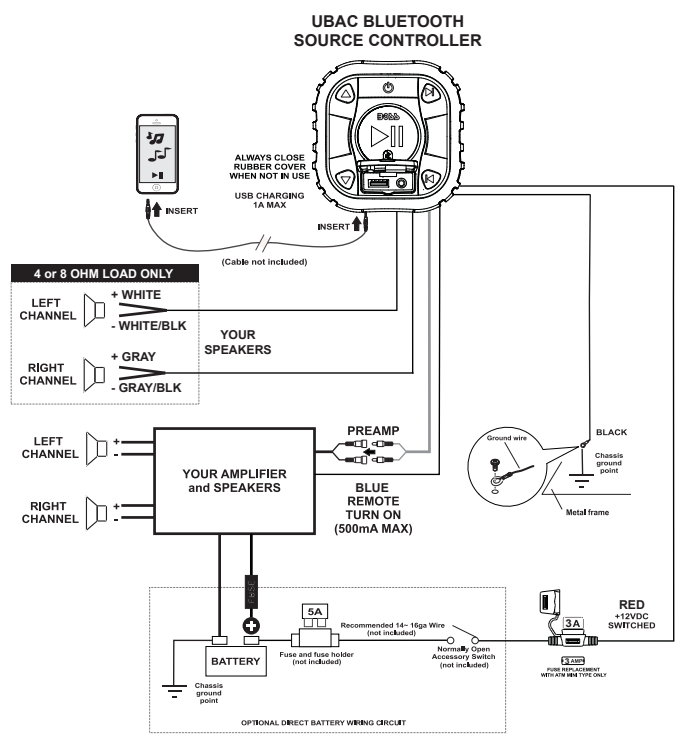

- RED ----- ACC SWITCHED (+12VDC)
- BLACK ----- GROUND
- BLUE ----- AMP REMOTE OUTPUT (+12VDC)
- RED RCA ----- RIGHT AUDIO OUTPUT
- WHITE RCA ----- LEFT AUDIO OUTPUT
- GRAY ----- RIGHT SPEAKER OUTPUT
- WHITE ----- LEFT SPEAKER OUTPUT

■ The ground cable length should not exceed 18 inches.

5



MOUNTING METHODS

- HANDLEBAR
- FLUSH MOUNT
- SURFACE MOUNT

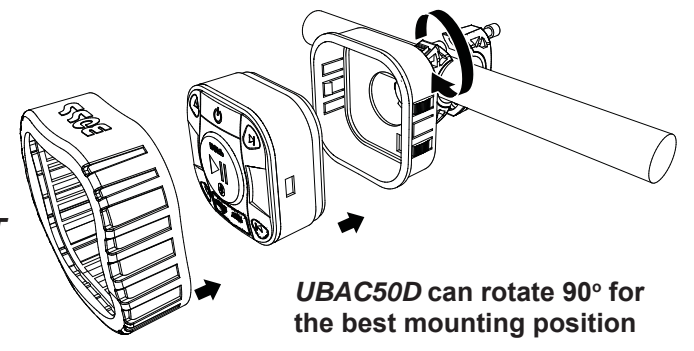

HANDLEBAR / CAGE MOUNT

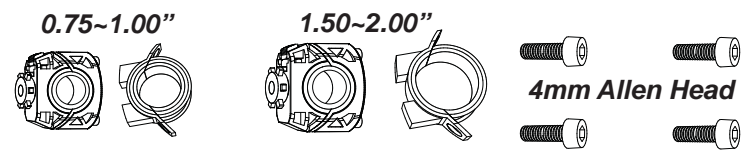

FLUSH MOUNT

- 1) Always check mounting depth before cutting
- 2) Use the flush bezel as template
- 3) Cutout hole exactly
- 4) Insert flush mount bezel, push side tabs outwards
- 5) Use optional silicon glue to give extra hold
- 6) Insert UBAC50D

SURFACE MOUNT

- 1) Check mounting depth before drilling
- 2) Use the flush bezel as template
- 3) Drill or cut wire hole exactly
- 4) Insert rubber trim around flush bezel, screw in place
- 5) Insert UBAC50D

TOOLS NEEDED: - 4mm Allen Wrench - Wire Crimpers

OPTIONAL TOOLS NEEDED: - Hand saw or Jigsaw

6



EN

QUICK START GUIDE

GETTING TO KNOW YOUR UBAC50D

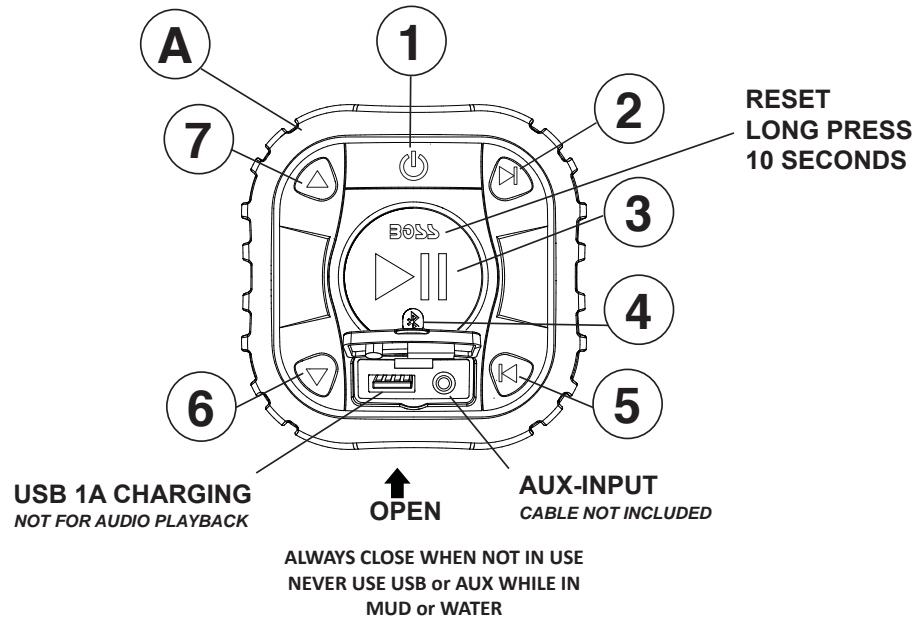

- A** UBAC50D MFC - MULTIFUNCTION CONTROLLER
- 1** POWER ON - Press and hold for 3 seconds
- 2** NEXT TRACK - Press and hold for Fast Forward
- 3** PLAY/PAUSE
- 4** BLUETOOTH PAIRING - LED BLUE COLOR
- 5** PREVIOUS TRACK - Press and hold for Fast Rewind
- 6** VOL DOWN
- 7** VOL UP

7

BOSS[®]
AUDIO SYSTEMS

BLUETOOTH OPERATION

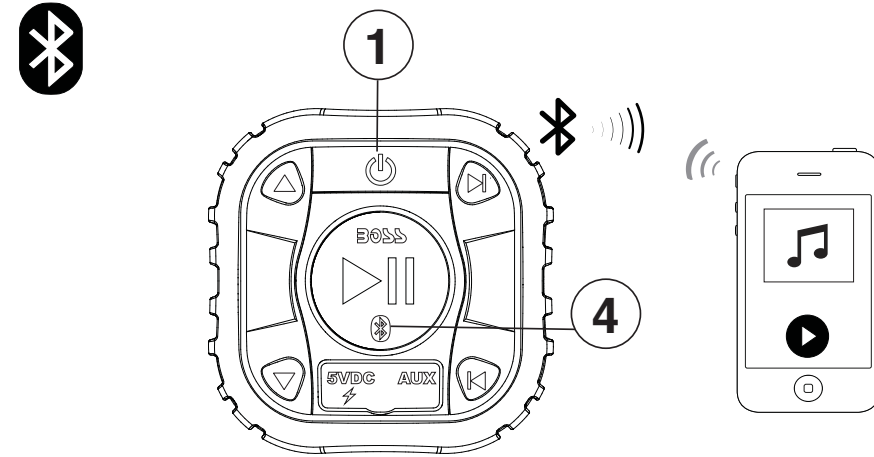

PAIRING & DISCOVERING A NEW BLUETOOTH CONNECTION

- 1) Power on the **UBAC50D** by long pressing **1** POWER button for 3 seconds
- 2) Long press the **BLUETOOTH** **4** button, the **BLUE LED** will start to rapidly flash, signalling that the **UBAC50D** is now ready for **BLUETOOTH** pairing.

NOTE: You have 2 minutes before you must restart this procedure over again.

- 3) Now that the **UBAC50D** is in pairing mode:

ANDROID users:

- a. Go into the **Settings Menu** of your **ANDROID** device
- b. Enter the **BLUETOOTH** Menu
- c. Turn ON **BLUETOOTH** and press **SCAN**
- d. "**BOSS UBAC50D**" will now be displayed under **AVAILABLE DEVICES**

8

BOSS[®]
AUDIO SYSTEMS

EN

QUICK START GUIDE

EN

QUICK START GUIDE

BLUETOOTH OPERATION (CON'T)

EN

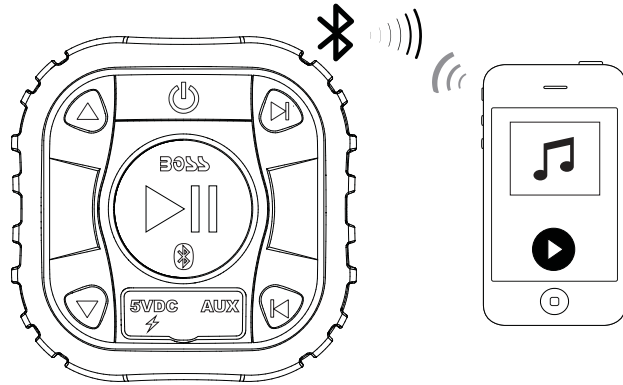

iOS users:

- a. Go into the Settings Menu of your iOS device
- b. Enter the **BLUETOOTH** Menu
- c. Turn **ON BLUETOOTH**
- d. Tap on “**BOSS UBAC50D**”
- e. If prompted, enter passcode: “0000”

4) If **BOSS AUDIO UBAC50D** is not seen, repeat the above steps to refresh the “Device List”

5) An audible confirmation **TONE** will be heard and the **BLUETOOTH LED** will illuminate solid when the connection is successful, you are now ready to stream music from your favorite media player **APP** to the **UBAC50D**



Tips:

To avoid battery exhaustion, be sure to occasionally run the vehicles engine while using this product.

9

BOSS[®]
AUDIO SYSTEMS

BLUETOOTH RECONNECTION

EN

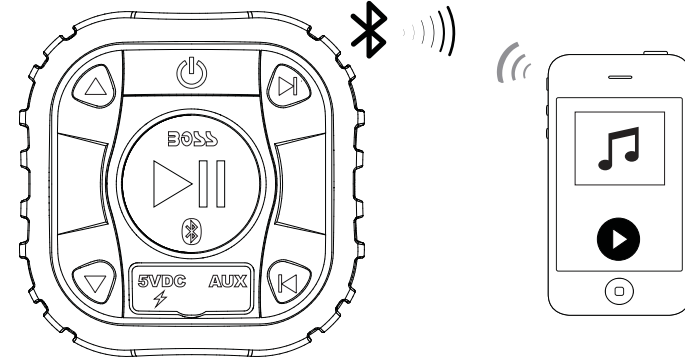

ONCE THE DEVICE IS BACK IN RANGE, IT SHOULD ATTEMPT TO AUTOMATICALLY RECONNECT

- 1) Power on the **UBAC50D** and your devices **BLUETOOTH**
- 2) The **BLUETOOTH LED** will flash slowly as it is looking for your previously paired device
- 3) The **UBAC50D** should now try to automatically reconnect to your last paired device
- 4) If your device was previously paired with the **UBAC50D**, but it wasn't the last paired device:

See page 8 for **PAIRING & DISCOVERING A NEW BLUETOOTH CONNECTION**

NOTE: If the device is out of range from the **UBAC50D**, it will disconnect automatically.

10

BOSS[®]
AUDIO SYSTEMS

STREAMING MUSIC CONTROL

EN

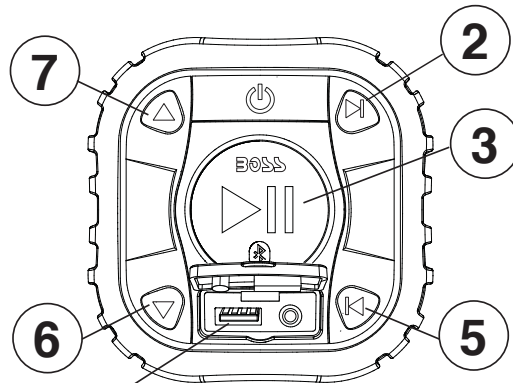

USB 1A CHARGING
NOT FOR AUDIO PLAYBACK

MULTIFUNCTION CONTROLLER BLUETOOTH OPERATION

- 1) Press the **3** **PLAY/PAUSE** once to start playing music or press the **PLAY** button from your devices touch screen
- 2) To skip songs or advance, press the **2** **NEXT TRACK** button
- 3) To select the previous song, press the **5** **PREVIOUS TRACK** button

VOLUME CONTROL

- 4) To raise the volume, press the **7** **VOL UP** button
- 5) To lower the volume, press the **6** **VOL DOWN** button
- 6) To **MUTE** the volume, press the **3** **PLAY/PAUSE** button



Tips: Before stowing: Make sure your devices MEDIA volume is set at 100% level.

11

BOSS[®]
AUDIO SYSTEMS

AUX-INPUT

EN

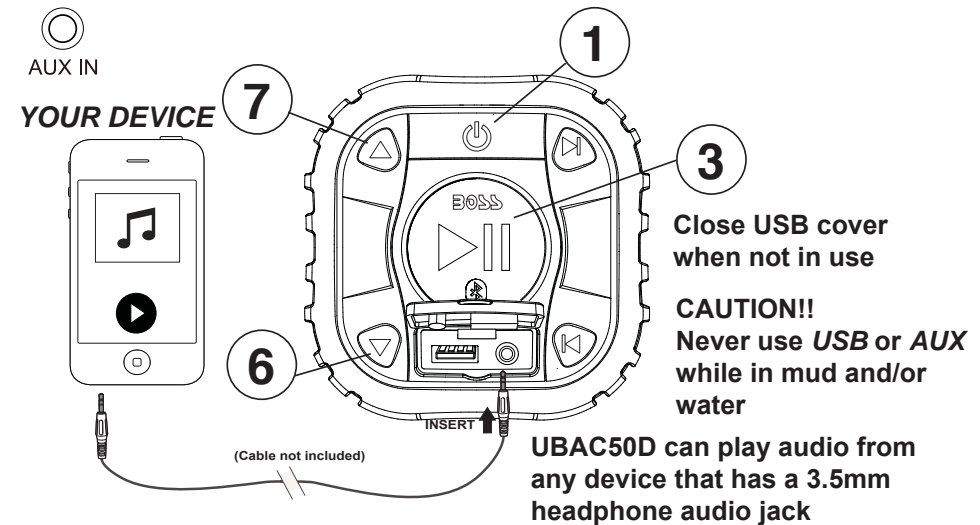

MULTIFUNCTION CONTROLLER AUX-IN OPERATION

- 1) Power on the **UBAC50D** by pressing and holding down the **1** **POWER** button for 3 seconds
- 2) Disconnect any paired Bluetooth device by turning off **BLUETOOTH** in your devices **SETTINGS MENU**
- 3) Under the protective door, connect your 3.5mm **AUX-IN** cable to your devices headphone jack
- 4) Route the **AUX-IN** wire back to **UBAC50D**, secure your device in a safe location

VOLUME CONTROL

- 5) To raise the volume, press the **7** **VOL UP** button
- 6) To lower the volume, press the **6** **VOL DOWN** button
- 7) To **MUTE** the volume, press the **5** **PLAY/PAUSE** button



Tips: Before stowing: Make sure your devices HEADPHONE volume is set at 100% level.

12

BOSS[®]
AUDIO SYSTEMS

TROUBLE SHOOTING

TECH SUPPORT: 805.322.8794

SYMPTOM

SOLUTION

No sound -----	Unit or Device is MUTED
No sound -----	Speaker is shorted
Audio is distorted -----	Bluetooth is out of range
No power indicator -----	Fuse is blown

SPECIFICATIONS

Power source: ----- 14.4VDC (10.8V~16V allowable)
 Grounding System: ----- Negative type
 Power Output: ----- 150W
 Preamp Output: ----- 2V RMS
 Preamp Impedance: ----- 600Ω
 Frequency Response: ----- 20-22kHz
 Speaker Impedance: ----- 4 or 8 Ω
 Maximum current: ----- 3A
 Bluetooth: ----- 4.1
 Class: ----- 2
 Range: ----- 33ft
 Profiles: ----- A2DP / GATT
 USB output: ----- 5VDC @ 1A
 Dimensions: HxDxW 4.05" x 1.65" x 4.05" / 200mm x 45mm x 200mm
 Unit weight: ----- 0.25lbs / 0.114kg
 Storage temperature: ----- -4°F to 160°F / -20°C to 70°C
 Operation temperature: ----- 32°F to 110°F / 0°C to 45°C

Replace fuse with rated 3A ATM type only

SPECIFICATIONS SUBJECT TO CHANGE WITHOUT NOTICE

NOTES

QUICK START GUIDE

QUICK START GUIDE