



Thank you for purchasing Leick Furniture products.
Contact customer service for comments or concerns.







Sheboygan, WI

920-451-4060

info@leickfurnituresince1910.com

www.leickfurnituresince1910.com

Assembly Instructions, #10110 Demilune Hall Stand

A: Top Assembly	
B: (3) Leg Frames	
C: Shelf	
D: (9) Bolts	
E: (9) Flat Washers	
F: (9) Lock Washers	
G: Allen Wrench	

Step 1

Place the shelf upside down. Fasten the legs and shelf with bolts. Do not tighten yet.

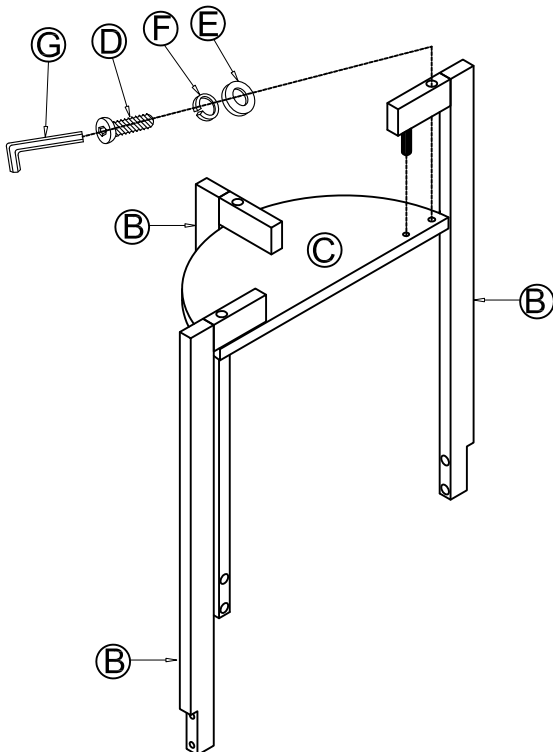

Step 2

Place the top upside down on a soft surface. Fasten the legs and top with bolts. Now tighten all bolts.

