

Aberdeen Sectional



Shown in fabric 11798-10, throw pillow fabric (TP) 11798-10, Espresso wood finish.

Pieces shown: P603-118, P603-115

Overall Height: 39" Seat Height: 22" Seat Depth: 23" Arm Height: 27"

Aberdeen Sectional

Standard Features	P603-010 Corner	P603-041 Large Armless	P603-061 Small Armless	P603-110/111 Right/Left Chaise	P603-114/115 Right/Left Two Seated End	P603-118/119 Right/Left Three Seated End w/ Corner
Loose Pillow Back	✓	✓	✓	✓	✓	✓
One 22" Non-Welted Down-Blend Throw Pillow (TP)	✓	N/A	N/A	✓	✓	✓ (2)
Wooden Leg Finish Choices	✓	✓	✓	✓	✓	✓
Harmony Cushion	✓	✓	✓	✓	✓	✓
Suspension System	sinuous	sinuous	sinuous	sinuous	sinuous	sinuous
Options - See Price List for Prices						
Extra Throw Pillows (XP)	✓	N/A	N/A	✓	✓	✓
Cloud Cushion	✓	✓	✓	✓	✓	✓

Aberdeen Bench Sectional

Standard Features	P603-010 Corner	P603-241 Large Armless	P603-061 Small Armless	P603-110/111 Right/Left Chaise	P603-244/245 Right/Left Two Seated End	P603-248/249 Right/Left Three Seated End w/ Corner
Loose Pillow Back	✓	✓	✓	✓	✓	✓
One 22" Non-Welted Down-Blend Throw Pillow (TP)	✓	N/A	N/A	✓	✓	✓ (2)
Wooden Leg Finish Choices	✓	✓	✓	✓	✓	✓
Harmony Cushion	✓	✓	✓	✓	✓	✓
Suspension System	sinuous	sinuous	sinuous	sinuous	sinuous	sinuous
Options - See Price List for Prices						
Extra Throw Pillows (XP)	✓	N/A	N/A	✓	✓	✓
Cloud Cushion	✓	✓	✓	✓	✓	✓

Pattern Availability: RG, PS, NM, RS

Note: PS, NM, & RS pattern types will have seams on bench cushions, front seat rail, in-back, and outback at back cushion breaks.

P603-110/111: RG and PS pattern types will have a seam about 4" in from back seam under back cushion.

This is a suggested application. Application is subject to change.
 Sizes and Dimensions will vary from piece to piece due to the individual hand craftsmanship used in every style we produce.
 All furniture style names are for internal reference only, not intended for commercial use.

Aberdeen Sectional

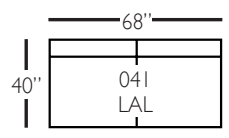
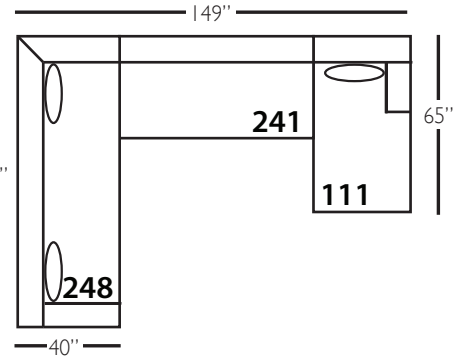
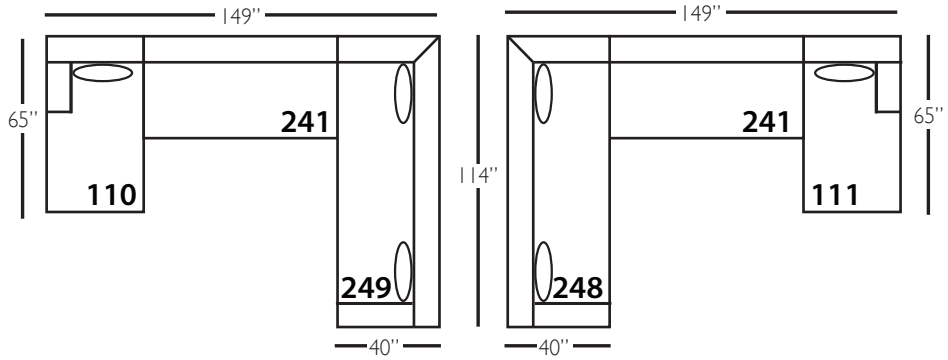
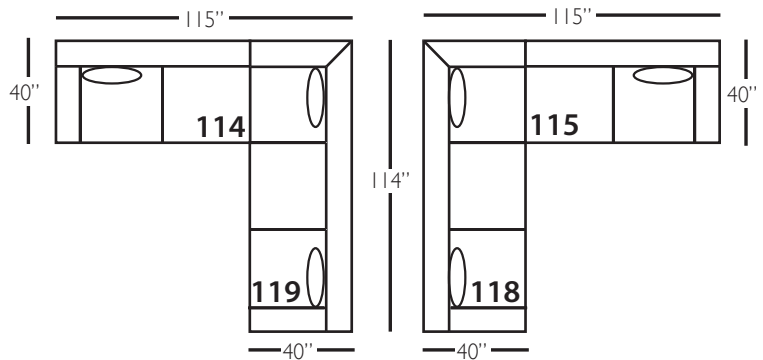
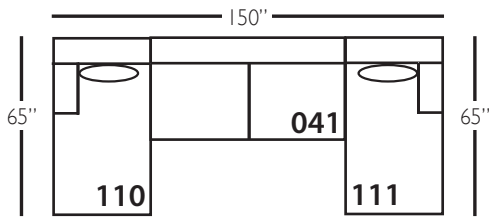

P603-041 - LAL

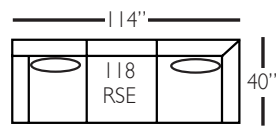

P603-118 - RSE
P603-119 - LSE

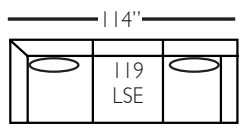

P603-114 - RSE
P603-115 - LSE

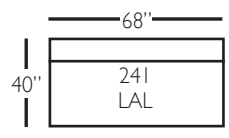
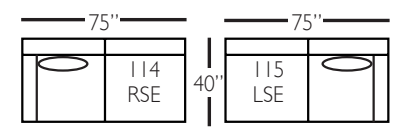

P603-241 - LAL

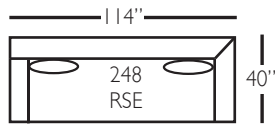

P603-248 - RSE
P603-249 - LSE

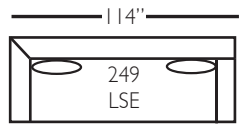

P603-244 - RSE
P603-245 - LSE

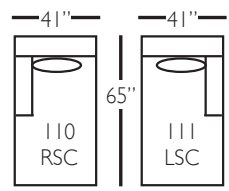
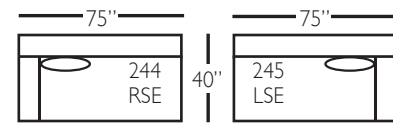

P603-110 - RSC
P603-111 - LSC

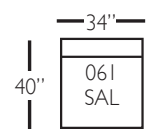

P603-061 - SAL

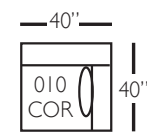

P603-010 - COR