

ITEM# 87360

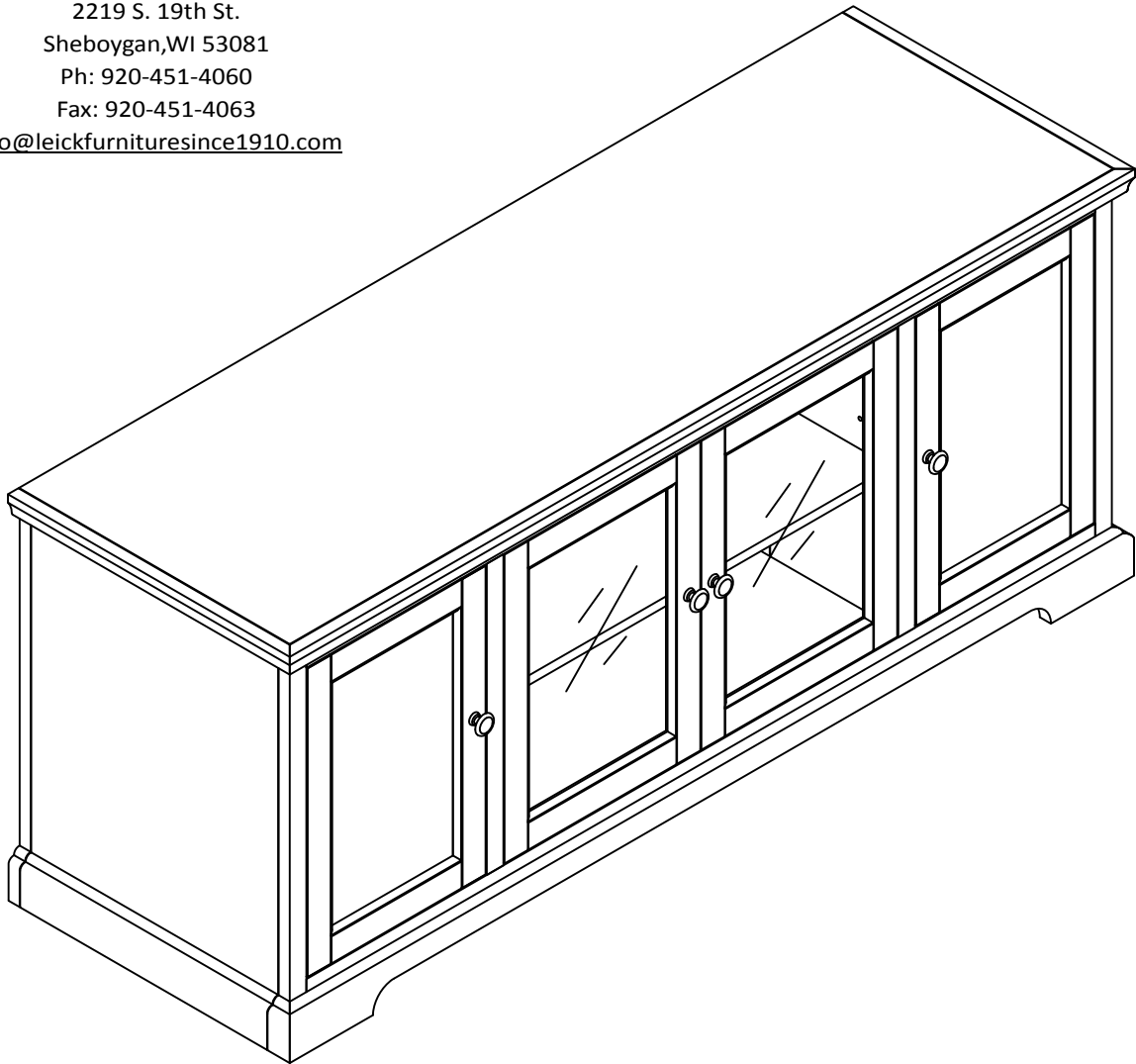



Westwood Cherry 25" H, 60" W Console

Leick
Home
SINCE 1910

2219 S. 19th St.
Sheboygan, WI 53081
Ph: 920-451-4060
Fax: 920-451-4063
info@leickfurnituresince1910.com

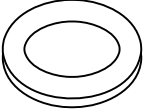
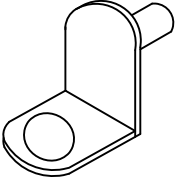
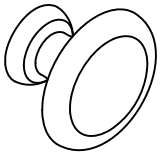

Hardware List

	Item	Description	Qty
a		Bolt 1/4" * 1-1/8"	6PCS
b		Allen wrench	1PC
c		Washer 1/4" * 12mm	6PCS
d		Shelf metal clip	12PCS
e		Door Pull	4PCS
f		Machine screw for door pull 5/32" * 3/4"	4PCS

Parts List

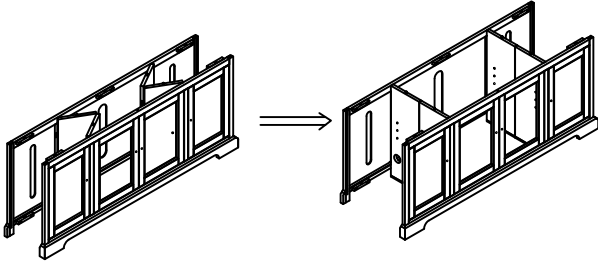
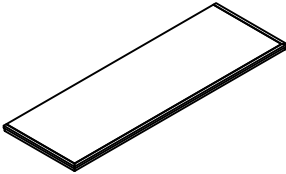
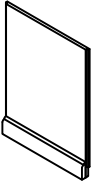
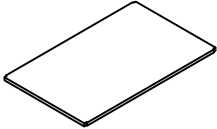
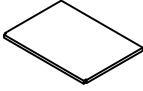
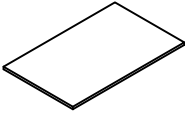
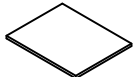
Item	Description	Qty
A	 Cabinet	1PC
B	 Top Panel	1PC
C	 Side Panel	2PCS
D	 Middle Bottom Panel	1PC
E	 Side Bottom Panel	2PCS
F	 Middle Adjustable Shelf	1PC
G	 Side Adjustable Shelf	2PCS

Assembly Instructions

Two person assembly recommended.

step 1

Unfold Cabinet.

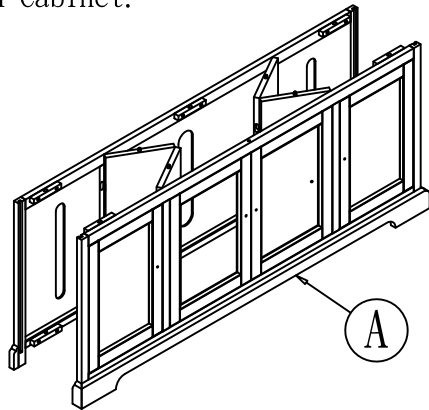

step 2

Open 4 doors. Insert the middle bottom panel first, then insert side bottom panels.

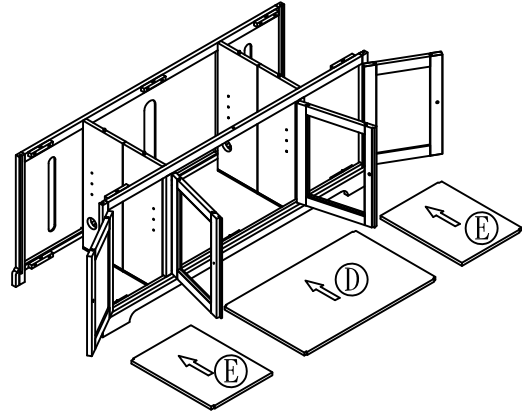

step 3

Insert two side panels.

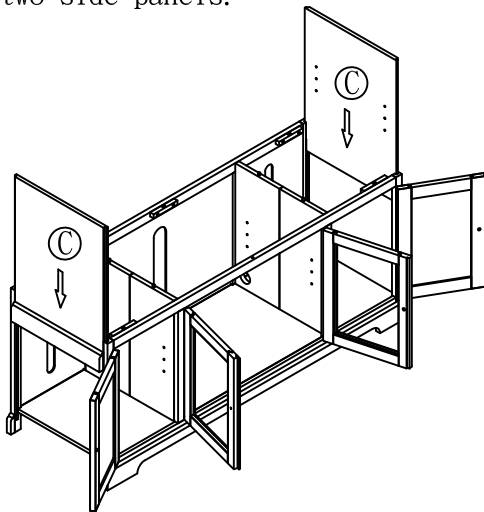

step 4

Bolt on top with 6 bolts.
DO NOT OVER TIGHTEN.

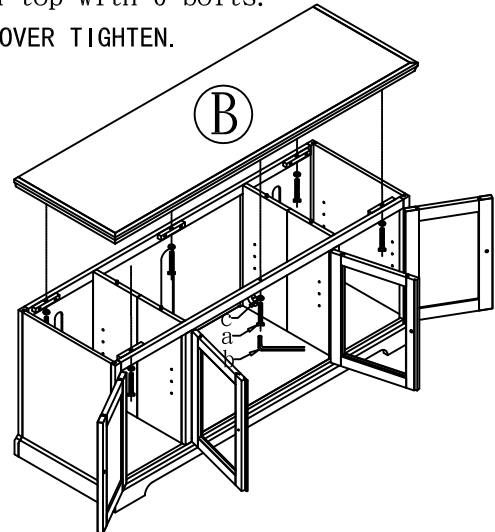

step 5

Install shelf clips and insert shelves.

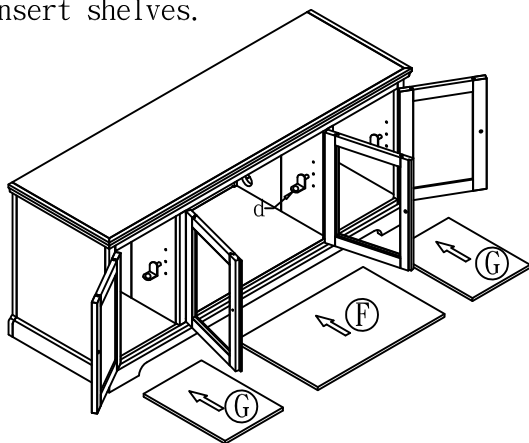

step 6

Install door pulls.

