

QUICKSTART "BASIC" INSTALLATION GUIDELINES FOR AN 1812 PLUS CABINET AND BY-PASS BOARD



120 Glasgow Avenue
Inglewood, California 90301
U.S.A.

It is highly recommended that you consult the Installation/Owner's manual for complete instructions on all the different types of installations. The 1812 Plus Telephone Entry System involves the installation of the 1812 Plus cabinet, the by-pass board for the incoming telephone line, and wiring of these components (On reverse side). Be sure that all dirt, metal or wood debris is removed from inside cabinet after mounting it. This could damage the control board and cause a malfunction during operation.

Remove Control Board from Cabinet

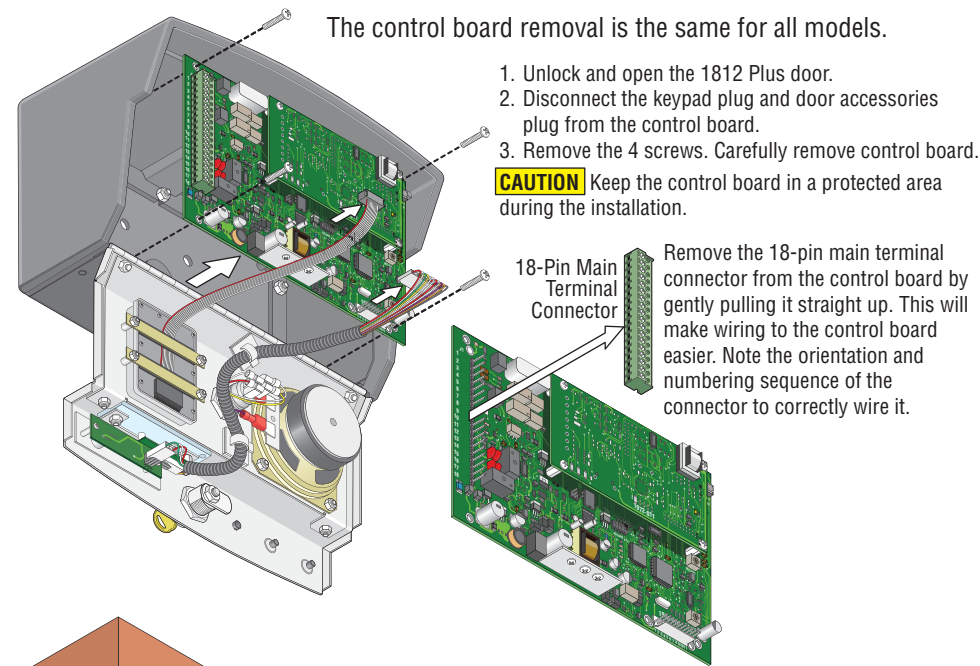

IMPORTANT The 1812 Plus and by-pass board **MUST** be properly grounded! A gooseneck mounting post anchored in concrete **does not** make a good ground.

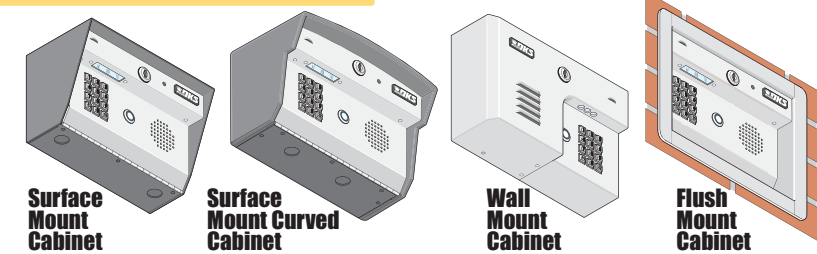

Install the By-Pass Board

The 1812 Plus by-pass board provides a method to by-pass the 1812 Plus and route the incoming telephone line directly to the homeowner's phone. **It must be installed as part of the 1812 Plus system.** All telephone wires for the 1812 Plus must pass through the by-pass board. Mount the by-pass board in a location that is easily accessible by the homeowner. In case of 1812 trouble or maintenance, the homeowner will use the by-pass switch on the board to route the incoming telephone line directly to their home phone. If the by-pass board is installed outdoors, it must be installed in a NEMA Type 4 enclosure (not supplied) with conduit to protect the board and wires from direct exposure to landscape sprinklers, rain, snow, and other elements.

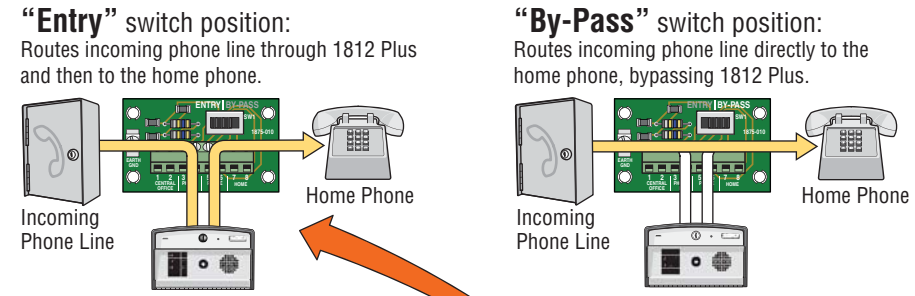

Mount Cabinet on a Mounting Post

Use existing 4 holes in cabinet box to bolt the surface or wall mount models on a DoorKing mounting post (there are several different styles available). Use the hardware that is supplied with the mounting post. Run all necessary wires through the post to the cabinet (See reverse side).

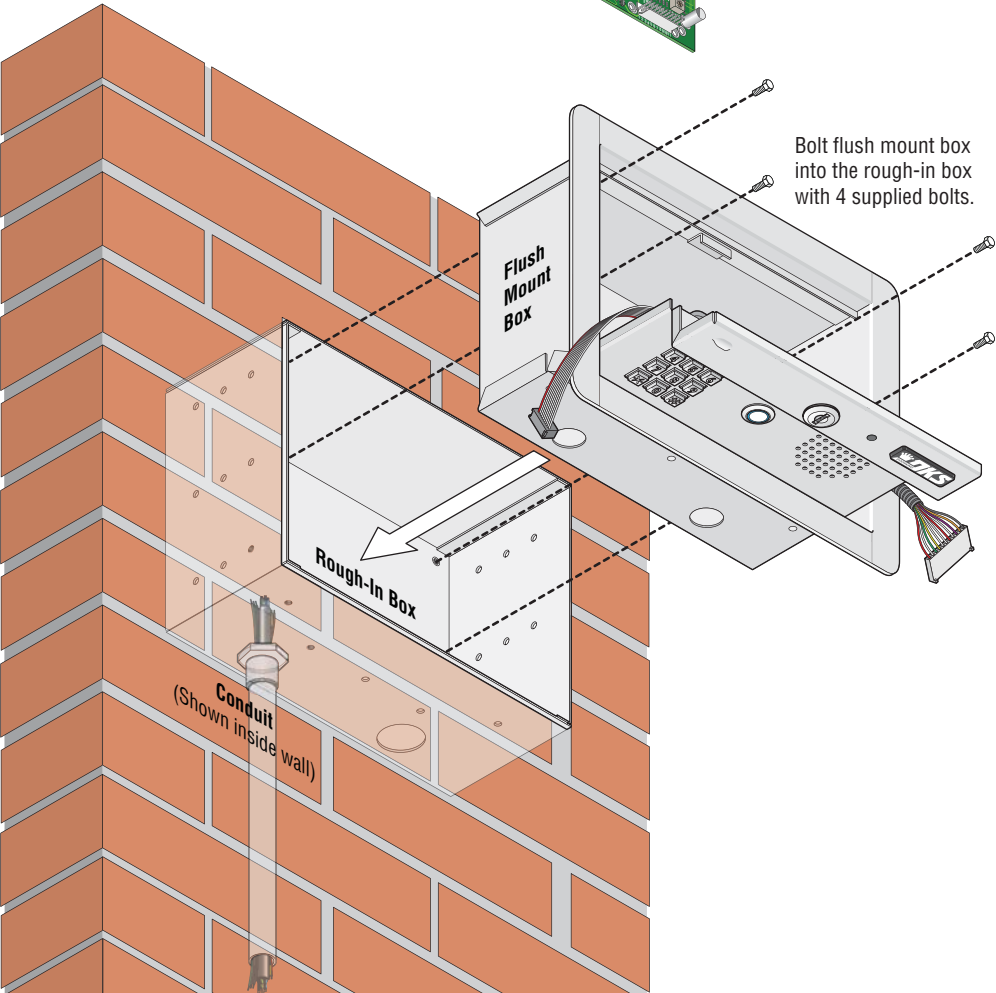
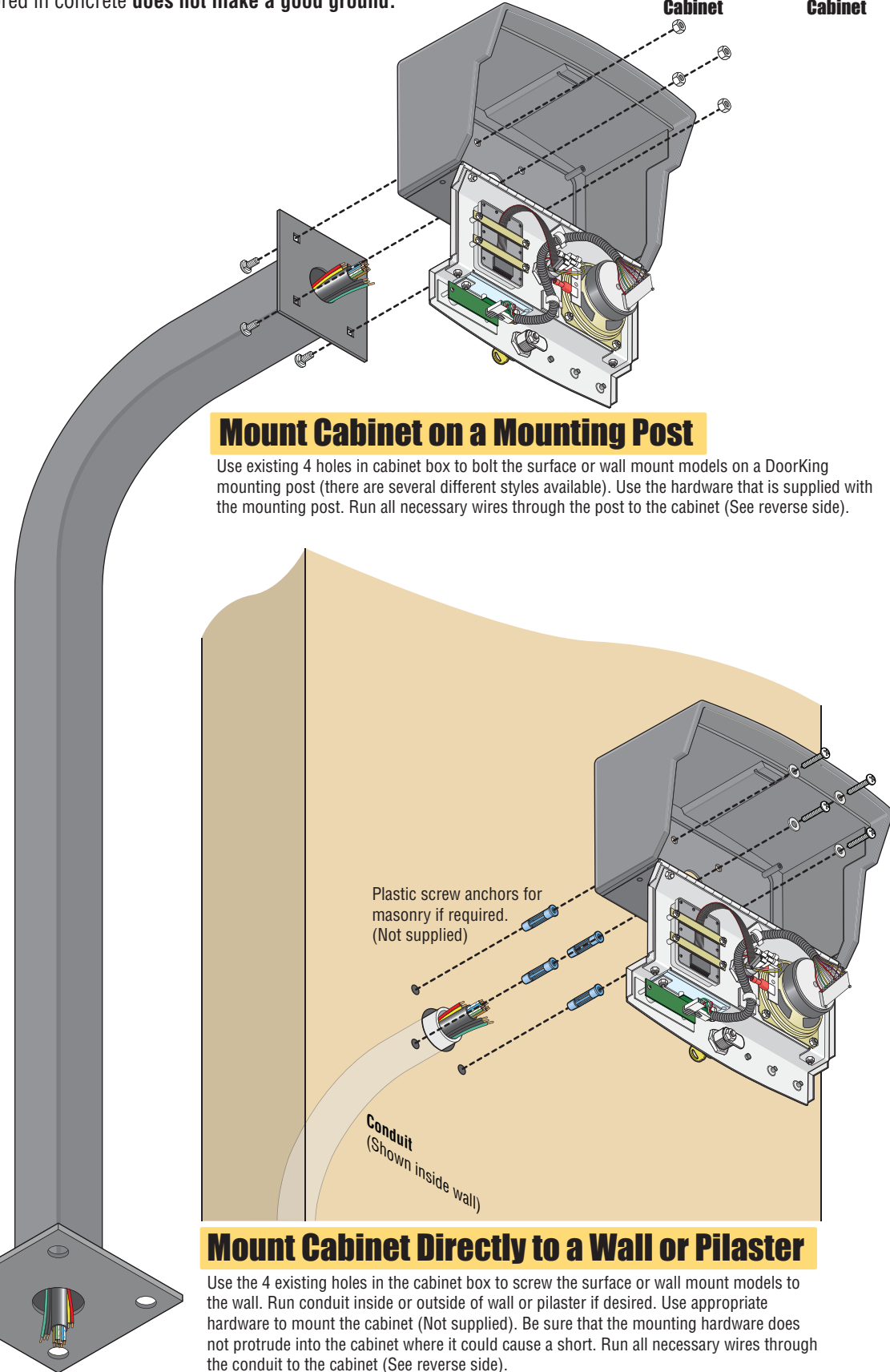

Flush Mount Cabinet in a Pilaster, Wall or Kiosk

Mount rough-in box into the pilaster, wall or kiosk. Run conduit inside wall into bottom of rough-in box if desired. Use appropriate hardware (Not supplied) to secure the rough-in box in place. Run all necessary wires through the conduit in to the rough-in box (See reverse side).

Mount Cabinet Directly to a Wall or Pilaster

Use the 4 existing holes in the cabinet box to screw the surface or wall mount models to the wall. Run conduit inside or outside of wall or pilaster if desired. Use appropriate hardware to mount the cabinet (Not supplied). Be sure that the mounting hardware does not protrude into the cabinet where it could cause a short. Run all necessary wires through the conduit to the cabinet (See reverse side).

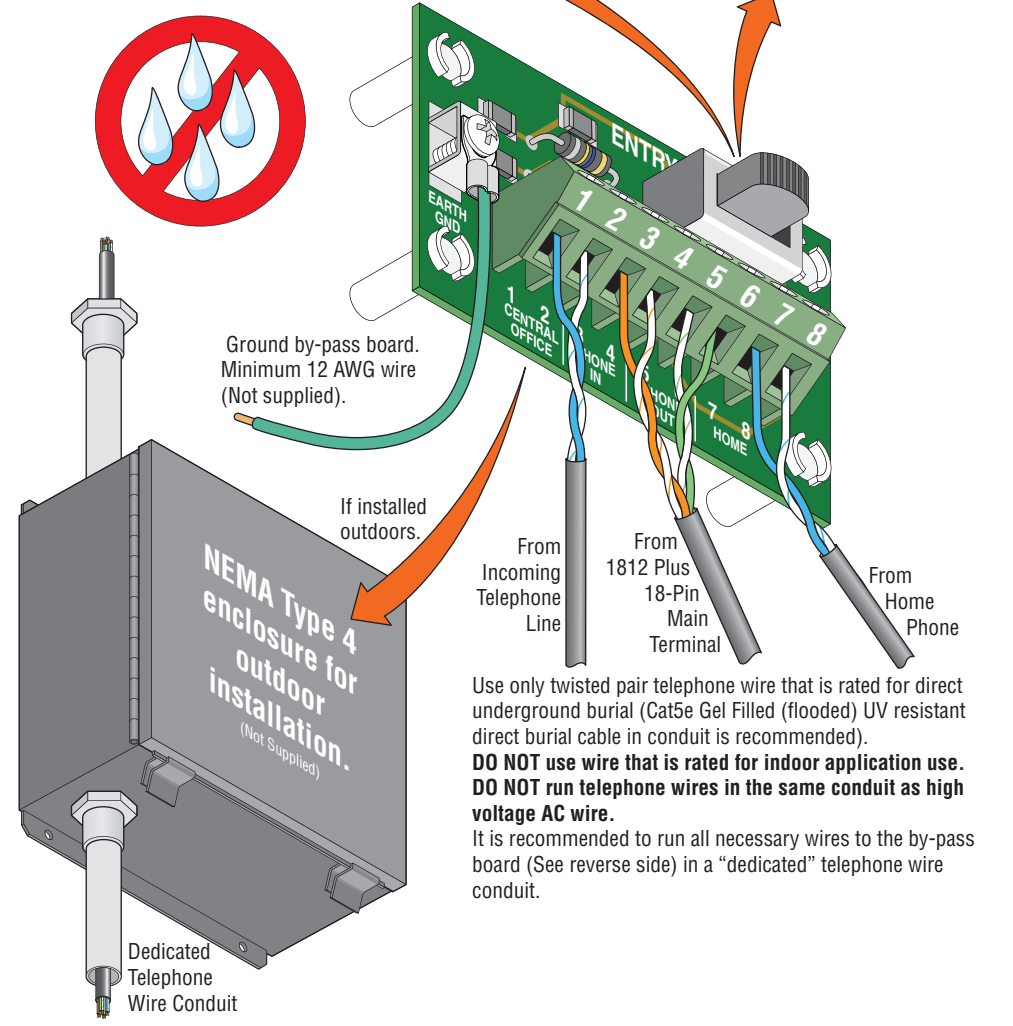

QUICKSTART "BASIC" WIRING GUIDELINES FOR AN 1812 PLUS SYSTEM WITH TWO ACCESS CONTROL DEVICES

It is highly recommended that you consult the Installation/Owner's manual for complete wiring instructions on all the different types of installations and programming.



120 Glasgow Avenue
Inglewood, California 90301
U.S.A.

Basic Programming for the 1812 Plus

The 1812 Plus has been programmed at the factory with many of the programming parameters (default setting) set for a typical residential application with a single 1812 Plus.

However, **you must program a "Master Code" before putting the 1812 Plus into service.** If you are using more than a single 1812 Plus in the system, or if you are using any of the advanced features of the 1812 Plus, such as Time Zones, Do-Not-Disturb Schedules, Call Forwarding, Holiday Schedules, Hold Open Schedules, Directory Code Dial-Out Phone Numbers, Temporary Access Codes, etc., you will need to download the complete Installation/Owner's and Programming Manual from our tech support web site.

Telephone Company Demarcation Point

Use common electrical safety practices when connecting telephone wires. You can receive a substantial jolt if the phone rings while handling these wires. "RING" terminal voltage varies and can be between -48 to -130 Volts AC, depending on the distance to the central office. "TIP" terminal is always positive with respect to RING terminal.

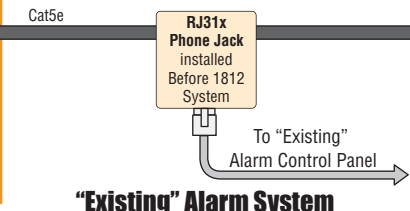
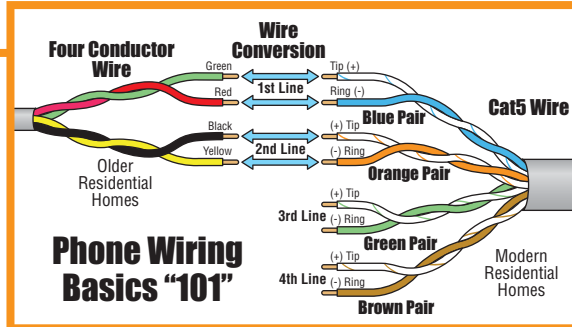
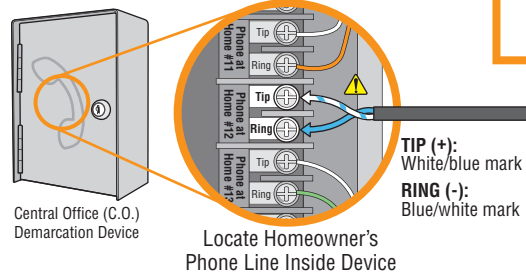

By-Pass Board

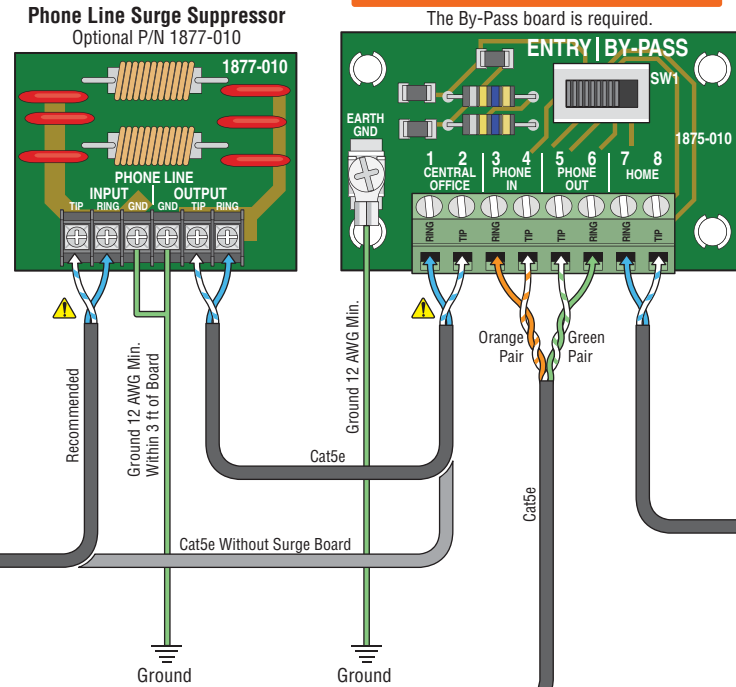

Telephone and RS 485 Wire Run (Cat5e) Table

Wire Size	Max Distance
24 AWG	800 ft
22 AWG	1600 ft
20 AWG	2200 ft
18 AWG	3600 ft

Check Polarity of Telephone Line
Check for polarity on the incoming telephone line to each board and maintain polarity throughout the telephone line (TIP (+), RING (-)).
Cat5e Gel Filled (flooded) UV resistant direct burial cable run in conduit recommended.
DO NOT run telephone wires in the same conduit as high voltage AC wire.

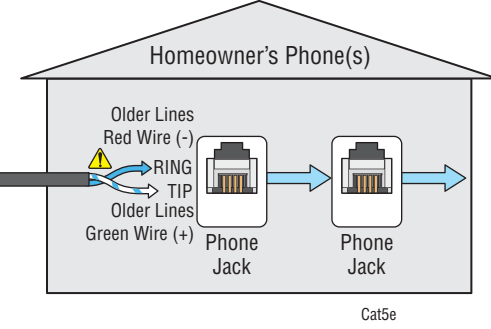

Complete Instructions

This "Quickstart" guideline is designed for installing a single 1812 Plus in a typical single family home application using the factory default settings programmed in the 1812 Plus. Complete installation instructions and programming manual is available on the enclosed CD **AND** from our tech support web site.
CLICK HERE TO VISIT DOOR KING'S TECHNICAL WEB SITE:
www.dkaccess.com/english/Telephone_Entry/telephone_entry.html

Access Control Devices

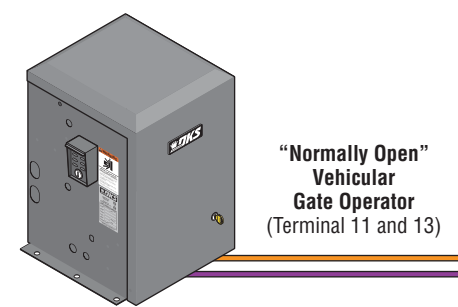

- Programming Relay 1 and 2 Strike Time -** (Factory default is 1 second)
- Press * 0 3 and enter the MASTER CODE. [* 0 3 ____ (beep)]
 - Enter "1" for relay 1 or "2" for relay 2, then press *. [_ * (beep)]
 - Enter a two-digit strike time (00-99), then press *. [__ * (beep)]
Note: Strike time entered in seconds. 00 = ¼ sec., 10 = 10 seconds, etc.
 - Repeat steps 2 and 3 to set the other relay strike time if necessary.
 - Press "0 #" TOGETHER to end. [0 # (beeeeeep)]

IMPORTANT All boards **MUST** be properly grounded or the system will **NOT** function correctly!

Control Board

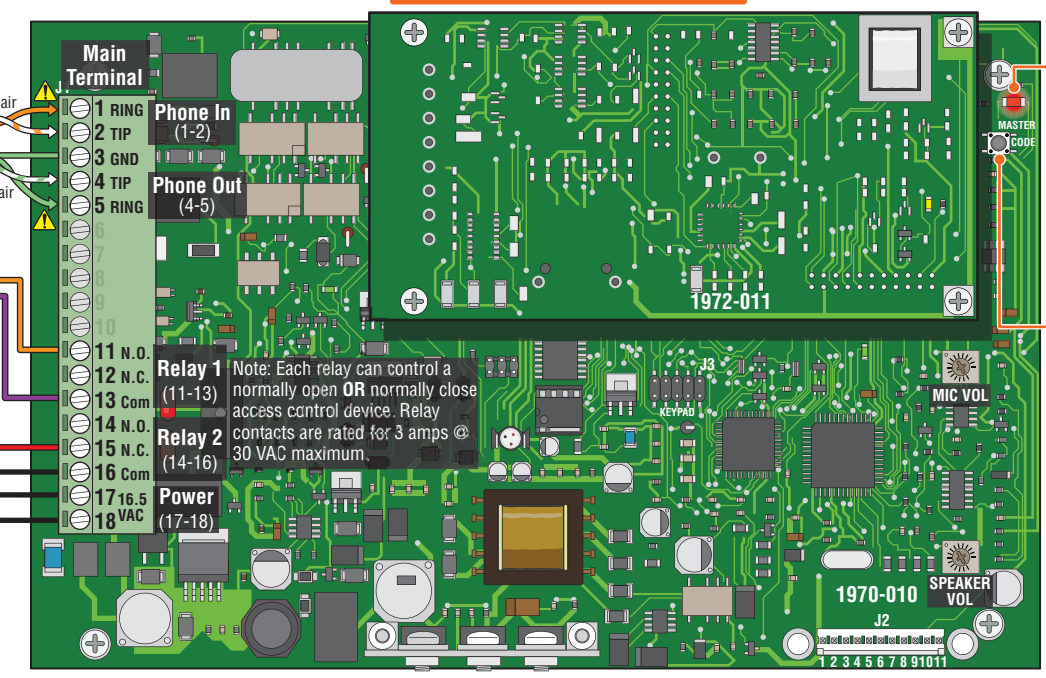

Program MASTER CODE

- Master Code LED Description**
- Blinking LED** - Power is applied to the 1812 Plus and the processor is working (Normal Mode).
 - LED ON Continuously** - After master code push button has been pressed, system will be in Master Code programming mode. (Will revert back to blinking LED if master code is not entered within 10-seconds).
- Push Button to Program "Master Code"**
- Press the Master Code push button. (the LED will stay on continuously).
 - Enter a four digit **Master Code** number then press " * ", "beep" will be heard. [____ (beep)] (Write down master code).

CAUTION
DO NOT power the 1812 Plus from a 24-Volt source (Such as a gate operator). **Damage will occur to the 1812 Plus** that is **NOT** covered under DoorKing's warranty.

Power Transformer and Access Control Device(s) Wire Run Table

Wire Size	Max Distance
18 AWG	100 ft
16 AWG	200 ft

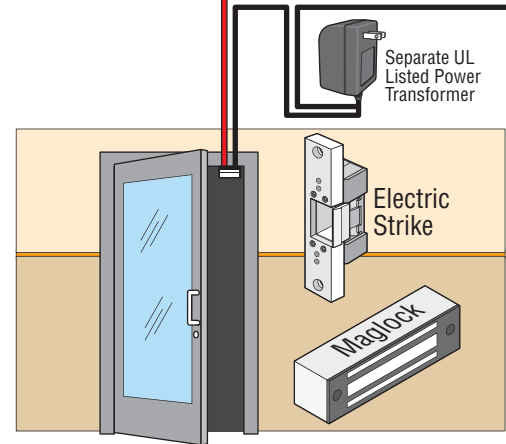
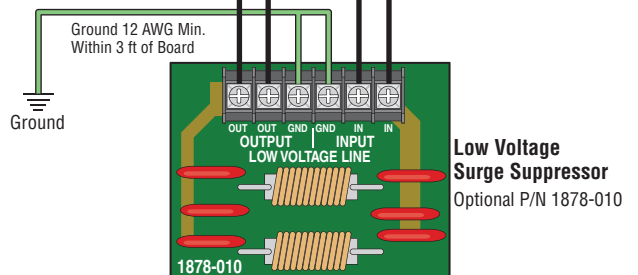
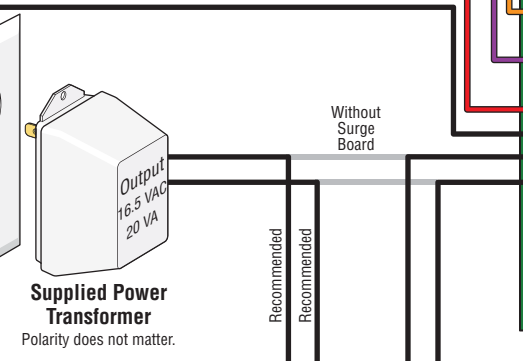

"Normally Close" Pedestrian Gate/Door with Maglock (Terminal 15 and 16)

"Normally Open" Pedestrian Gate/Door with Electric Strike (Terminal 14 and 16)

Magnetic locks or electric strikes must be powered from a separate UL Listed power transformer. **DO NOT** power electric strikes or magnetic locks from the 1812 Plus power transformer. keep power wire runs as short as possible.

Programming Simple Access Codes

- Programming Simple Access Code(s) to Operate Relay 1 and/or 2 on a 24/7 Basis -** (Maximum of 50 codes)
- Press * 0 2 and enter the MASTER CODE. [* 0 2 ____ (beep)]
 - Press 1 for relay 1 **OR** Press 2 for relay 2, then press *. [_ * (beep)]
 - Choose and** enter a five-digit **simple** access code, then press *. [____ * (beep)]
 - Repeat steps 2 and 3 to enter additional **simple access codes**.
 - Press "0 #" TOGETHER to end. [0 # (beeeeeep)]