



February 11, 2025

To: Whom it may concern,
From: Building Drops, Inc.
On behalf of: Glass Warehouse/Future Glass
1319 Rocky Point Drive, Suite 200
Oceanside, CA 92056
Report: PER 9535
Subject: ARA-BPSQ Glass Spigot Clamping System

Scope:

The purpose of this report is to evaluate the performance of the ARA-BPSQ Spigot Clamping System manufactured by Glass Warehouse. The conditions in this report meet all the applicable requirements of the current International Building Code. Glass thicknesses and properties were extracted from ASTM E1300. Steel members and connections were designed according to AISC Design Guides. ICC Acceptance Criteria AC439 and ASTM E2358 were used for determining applicable design criteria for railing systems. A summary of standards can be found on the following pages.

Only rectangular glass is covered within this report, different glass shapes do not apply to this analysis. Gaskets may be modified according to different glass thicknesses as long as thickness is specified in this analysis.

For fall protection requirements, this product has been analyzed in accordance with section 1607.9.1 and meets the requirements of the 50 plf linear load and 200 lb concentrated load specified in ASCE 7 section 4.5.1.

The glass spigot system uses 2205 stainless steel clamps to point support the glass lights specified herein. The glass spigot system has been designed for the following loading conditions:

- 200 lb concentrated load at the top of glass or at the top rail
- 50 lbs linear load applied at the top of glass or at the top rail
- Allowable wind load as shown on the tables within this report

This report provides glass thicknesses the spigots have been designed to support. Other glass thicknesses may be used but are outside of the scope of this report.

Instructions for Use

1. Select desired glass composition from tables 5, 7, 8, 9, 10, 11, or 12.
2. Determine max. glass size based on wind load requirements.
3. Using table 13, verify that the allowable installation load at desired size is greater than the allowable wind load of the desired glass size.

Project Description: Glass Warehouse/Future Glass ARA-BPSQ Spigot Engineering Analysis	Date: February 11, 2025	Customer: Glass Warehouse/Future Glass	
		Project #: EEV-24-0853	
	Engineer: SH	PER: 9535	Page #: Page 1 of 33

ARA-BPSQ Glass Spigot Clamping System

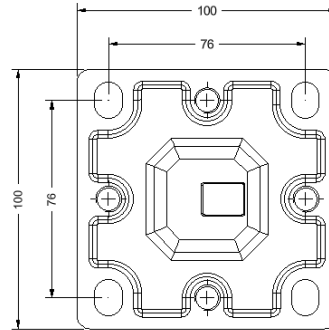
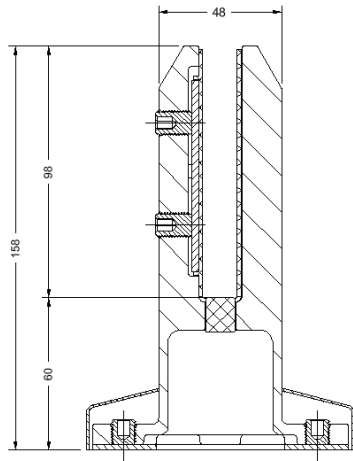

Note: (4) installation anchors per spigot.

Standards/Referenced Publications

ASTM E1300	IBC 1607.8.1	ICC AC439
ASTM E2358	AISC Design Guides	ASTM C1048-97b
CPSC 16 CFR 1201	ANSI Z97.1	AAMA CW-12-84, Structural Properties for glass
AISC Design Guide 27	IBC 2407.1.1	NDS 2018
ASTM E6.2.1.1	SEI/ASCE 8-02	

Project Description: Glass Warehouse/Future Glass ARA-BPSQ Spigot Engineering Analysis	Date: February 11, 2025	Customer: Glass Warehouse/Future Glass	
	Engineer: SH	Project #: EEV-24-0853	
		PER: 9535	Page #: Page 2 of 33



Limits of Use:

1. This product has been evaluated and is in compliance with the 2015, 2018, and 2021 editions of the International Building Code.
2. Product installation shall be as listed herein. Site conditions that deviate from those specified shall require further engineering analysis by a licensed engineer or registered architect.
3. When used in areas requiring wind borne debris protection this product complies with chapter 16 of the 2015, 2018, and 2021 editions of the International Building Code and does require an impact resistant covering in areas requiring impact resistance.

Conclusion:

In my professional opinion, the ARA-BPSQ Spigot Clamping System manufactured by Glass Warehouse is adequate for use under the limitations provided within this report.

I trust that this will satisfy your needs, however, feel free to call if you have any questions.

***Certification of Independence:** Please note that I do not have nor will I acquire a financial interest in any company manufacturing or distributing the product(s) for which this report is being issued. Also, I do not have nor will I acquire a financial interest in any other entity involved in the approval process of the listed product(s).*

Project Description: Glass Warehouse/Future Glass ARA-BPSQ Spigot Engineering Analysis	Date: February 11, 2025	Customer: Glass Warehouse/Future Glass	
		Project #: EEV-24-0853	
	Engineer: SH	PER: 9535	Page #: Page 3 of 33

Wind Loads on Fences or Guards

The wind load table below has been calculated in accordance with ASCE 7 section 29.4, Design Wind Loads on Solid Freestanding Wall and Solid Signs. This section is applicable for free standing building guard rails, wind walls, and balcony railings that return to building walls. The values listed in the table below are generic values for heights up to 15 ft and may not reflect the values needed for a specific jobsite. If site specific wind loads are required, a licensed engineer shall prepare site specific wind loads for use with this product.

Wind Loads (PSF)						
Wind Speed (mph)	W _{ASD} for C _f = 1.3			W _{ASD} for C _f = 2.6		
	Exp. B K _z = 0.7	Exp. C K _z = 0.85	Exp. D K _z = 1.03	Exp. B K _z = 0.7	Exp. C K _z = 0.85	Exp. D K _z = 1.03
100	9.50	11.53	13.98	19.00	23.07	27.95
110	11.49	13.95	16.91	22.98	27.91	33.82
120	13.68	16.61	20.12	27.35	33.21	40.25
130	16.05	19.49	23.62	32.10	38.98	47.24
140	18.62	22.60	27.39	37.23	45.21	54.78
150	21.37	25.95	31.44	42.74	51.90	62.89
160	24.31	29.52	35.78	48.63	59.05	71.55
170	27.45	33.33	40.39	54.90	66.66	80.78
180	30.77	37.37	45.28	61.54	74.73	90.56

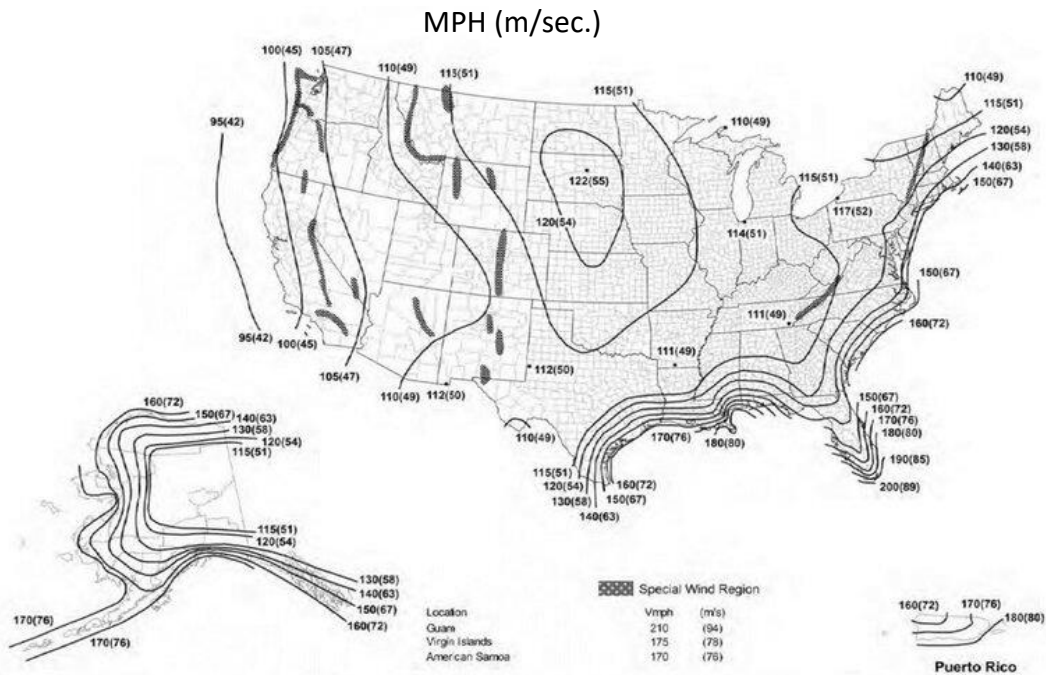

Project Description: Glass Warehouse/Future Glass ARA-BPSQ Spigot Engineering Analysis	Date: February 11, 2025	Customer: Glass Warehouse/Future Glass	
	Engineer: SH	Project #: EEV-24-0853	
		PER: 9535	Page #: Page 4 of 33

Analysis and Findings

Under the appropriate load conditions for the system, the three main load cases are summarized below,

$$V_c = 50\text{plf} \cdot S/2$$

$$M_c = 50\text{plf} \cdot 42 \cdot S/2$$

50 plf along glass

$$V_c = 200/C_c$$

$$M_c = V_c \cdot 42$$

200 lbs concentrated load

$$V_c = w \cdot H \cdot S/2$$

$$M_c = V_c \cdot H \cdot 0.55$$

Wind load

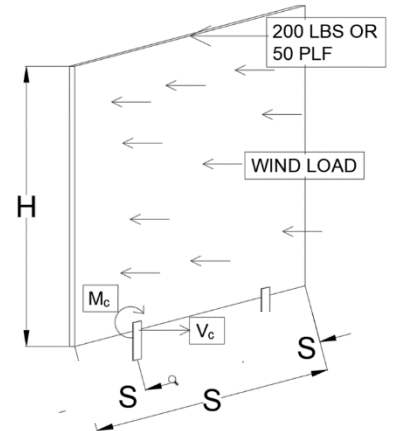

The loads were developed according to ASTM E2358 for Performance Level 2 (Type L2).

Spigots shall be located at 1/5-1/4 of the glass width. 2 spigots per glass panel.

Glass Strength

Table 1: Glass properties extracted from ASTM E1300

Glass properties				
Glass types	Modulus of rupture, psi	All. Bending Stress, psi	All. Compressive Stress, psi	All. Glass Stress per ASTM E1300, psi
Tempered	24000	6000	6000	10600
Heat Strengthened	12000	3000	3000	5300
Annealed	6000	1500	1500	2900

1/2" Monolithic Tempered Glass Capacity Calculations

Table 1: Moment Amplification Factor for Uniform Loading at Top of Glass

Glass Height (in.)	Glass Width (in.)				
	36	48	60	68	72
36	2.13	2.71	3.35	3.77	3.98
42	2.15	2.76	3.38	3.80	4.02
48	2.19	2.81	3.43	3.85	4.07
60	2.22	2.83	3.45	3.88	4.10

Project Description: Glass Warehouse/Future Glass ARA-BPSQ Spigot Engineering Analysis	Date: February 11, 2025	Customer: Glass Warehouse/Future Glass	
	Engineer: SH	Project #: EEV-24-0853	
		PER: 9535	Page #: Page 5 of 33



Table 2: Moment Amplification Factor for Uniform Wind Loading

Glass Height (in.)	Glass Width (in.)				
	36	48	60	68	72
36	1.98	2.53	3.15	3.55	3.75
42	2.01	2.60	3.20	3.61	3.81
48	2.07	2.67	3.27	3.68	3.89
60	2.12	2.72	3.32	3.32	3.95

Table 3: Deflection Amplification Factor for Live Loading

Glass Height (in.)	Glass Width (in.)				
	36	48	60	68	72
36	1.00	1.14	1.29	1.39	1.45
42	1.00	1.12	1.25	1.35	1.40
48	1.00	1.11	1.23	1.31	1.36
60	1.00	1.09	1.19	1.26	1.29

Table 4: Deflection Amplification Factor for Uniform Wind Loading

Glass Height (in.)	Glass Width (in.)				
	36	48	60	68	72
36	0.99	1.15	1.32	1.46	1.53
42	0.99	1.13	1.29	1.40	1.46
48	1.00	1.12	1.27	1.37	1.42
60	1.00	1.10	1.22	1.31	1.35

Project Description: Glass Warehouse/Future Glass ARA-BPSQ Spigot Engineering Analysis	Date: February 11, 2025	Customer: Glass Warehouse/Future Glass	
	Engineer: SH	Project #: EEV-24-0853	
		PER: 9535	Page #: Page 6 of 33



Table 5: 1/2" Monolithic Tempered Glass Allowable Wind Load

Allowable Wind Load (PSF)					
Glass Height (in.)	Glass Width (in.)				
	36	48	60	68	72
36	39.64	31.00	24.96	22.13	20.93
42	28.70	22.18	18.01	15.98	15.13
48	21.36	16.56	13.51	12.00	11.36
60	13.36	10.41	8.51	8.51	7.15

Table 6: Deflection from 50 plf Load on 1/2" Monolithic Tempered Glass

Deflection from 50plf Load (in.)					
Glass Height (in.)	Glass Width (in.)				
	36	48	60	68	72
36	0.73	0.82	0.93	1.01	1.05
42	1.15	1.29	1.44	1.55	1.61
48	1.72	1.90	2.11	2.25	2.33
60	3.36	3.65	3.98	4.22	4.34

Project Description: Glass Warehouse/Future Glass ARA-BPSQ Spigot Engineering Analysis	Date: February 11, 2025	Customer: Glass Warehouse/Future Glass	
	Engineer: SH	Project #: EEV-24-0853	
		PER: 9535	Page #: Page 7 of 33



Allowable Wind Load Tables for Laminated Glass

Table 7: 7/16" O.A. Laminated Glass: 3/16" Tempered Glass – 0.060" PVB – 3/16" Tempered Glass

Allowable Wind Load (PSF)					
Glass Height (in.)	Glass Width (in.)				
	36	48	60	68	72
36	17.33	13.55	10.91	9.67	9.15
42	13.50	10.44	8.48	7.52	7.12
48	10.73	8.32	6.79	6.03	5.71
60	7.46	5.81	4.75	4.75	3.99

Table 8: 7/16" O.A. Laminated Glass: 3/16" Tempered Glass – 0.060" PVB Stiff – 3/16" Tempered Glass

Allowable Wind Load (PSF)					
Glass Height (in.)	Glass Width (in.)				
	36	48	60	68	72
36	23.30	18.22	14.67	13.01	12.31
42	17.92	13.85	11.25	9.98	9.45
48	13.96	10.82	8.83	7.84	7.43
60	9.29	7.24	5.91	5.91	4.97

Table 9: 7/16" O.A. Laminated Glass: 3/16" Tempered Glass – 0.060" SentryGlas – 3/16" Tempered Glass

Allowable Wind Load (PSF)					
Glass Height (in.)	Glass Width (in.)				
	36	48	60	68	72
36	29.74	23.25	18.72	16.60	15.70
42	21.88	16.91	13.73	12.18	11.53
48	16.46	12.76	10.41	9.25	8.75
60	10.43	8.13	6.64	6.64	5.58

Project Description: Glass Warehouse/Future Glass ARA-BPSQ Spigot Engineering Analysis	Date: February 11, 2025	Customer: Glass Warehouse/Future Glass	
	Engineer: SH	Project #: EEV-24-0853	
		PER: 9535	Page #: Page 8 of 33



Table 10: 9/16" O.A. Laminated Glass: 1/4" Tempered Glass – 0.060" PVB – 1/4" Tempered Glass

Allowable Wind Load (PSF)					
Glass Height (in.)	Glass Width (in.)				
	36	48	60	68	72
36	23.83	18.63	15.00	13.30	12.58
42	18.45	14.26	11.58	10.27	9.72
48	14.60	11.32	9.23	8.20	7.76
60	10.12	7.89	6.44	6.44	5.42

Table 11: 9/16" O.A. Laminated Glass: 1/4" Tempered Glass – 0.060" PVB Stiff – 1/4" Tempered Glass

Allowable Wind Load (PSF)					
Glass Height (in.)	Glass Width (in.)				
	36	48	60	68	72
36	31.65	24.75	19.93	17.67	16.72
42	24.41	18.87	15.32	13.60	12.87
48	19.08	14.79	12.07	10.72	10.15
60	12.78	9.96	8.14	8.14	6.84

Table 12: 9/16" O.A. Laminated Glass: 1/4" Tempered Glass – 0.060" SentryGlas – 1/4" Tempered Glass

Allowable Wind Load (PSF)					
Glass Height (in.)	Glass Width (in.)				
	36	48	60	68	72
36	41.35	32.33	26.03	23.08	21.84
42	30.51	23.58	19.15	16.99	16.08
48	22.99	17.83	14.55	12.92	12.23
60	14.61	11.38	9.30	9.30	7.82

Project Description: Glass Warehouse/Future Glass ARA-BPSQ Spigot Engineering Analysis	Date: February 11, 2025	Customer: Glass Warehouse/Future Glass	
	Engineer: SH	Project #: EEV-24-0853	
		PER: 9535	Page #: Page 9 of 33



ARA-BPSQ Spigot Installation

Anchor Schedule

Anchor Schedule				
Substrate	Anchor Type	Min. Embedment (in.)	Min. Edge Distance (in.)	Allowable Moment (in-lb)
Wood SG = 0.55 min.	5/16" ASTM F593 Bolt	3.00	1.00	40246.58
Concrete 3000 PSI min.	1/4" Dewalt Screw-Bolt+	2.50	2.50	7045.27
Steel 16 Ga. Min.	5/16" ASTM F593 Bolt	Min. 3 threads penetration past steel structure	0.50	38559.60

Table 13: Installation Design Pressure Table

Spigot Base Installation Allowable Wind Load (PSF)					
Glass Height (in.)	Glass Width (in.)				
	36	48	60	68	72
36	142.51	106.88	85.50	75.45	71.25
42	102.94	77.20	61.76	54.50	51.47
48	77.82	58.36	46.69	41.20	38.91
60	48.94	36.70	29.36	25.91	24.47

Project Description: Glass Warehouse/Future Glass ARA-BPSQ Spigot Engineering Analysis	Date: February 11, 2025	Customer: Glass Warehouse/Future Glass	
	Engineer: SH	Project #: EEV-24-0853	
		PER: 9535	Page #: Page 10 of 33

Cap Rail Allowable Span Calculations

Guard applications require a top rail or handrail. The rail shall have adequate strength to support the live load of 200 lb concentrated or 50 plf distributed load assuming the failure of one glass light at the location of the loading. No US building codes or adopted standards define the limit state of the guard cap rail for this condition. IBC 2407.1.2 states “shall be otherwise supported to remain in place should one baluster fail.” There is no additional explanation in the IBC as to how this is to be determined. ICC Acceptance Criteria 439 was adopted to provide a methodology for determining if a glass balustrade guard meets the requirements of IBC 2407. ICC AC 439 requires the rail to be capable of supporting a 334# load (SF = 1.67 for 200# load) with no more than 12” deflection, yielding or other damage is permitted since the loss of a glass light will necessitate guard repairs. For light failure only the horizontal load case applies for laminated glass.

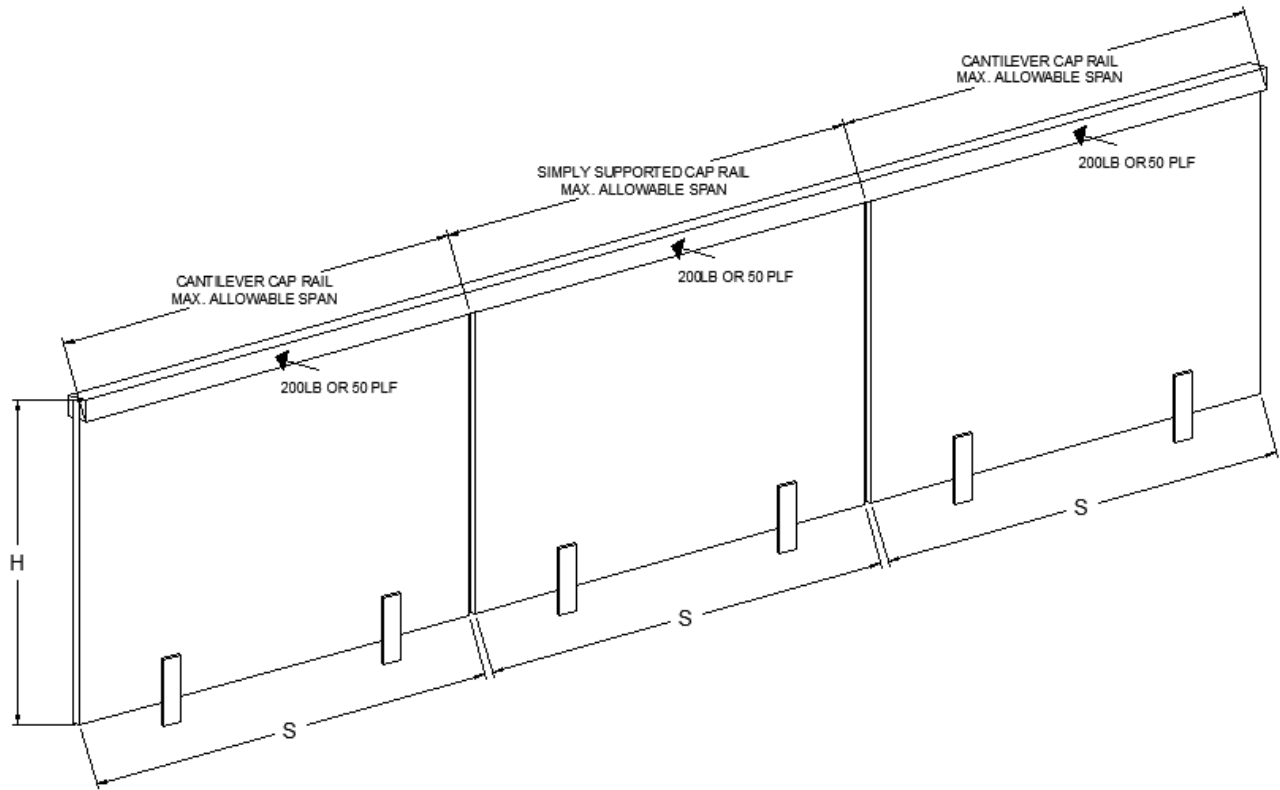

Project Description: Glass Warehouse/Future Glass ARA-BPSQ Spigot Engineering Analysis	Date: February 11, 2025	Customer: Glass Warehouse/Future Glass	
	Engineer: SH	Project #: EEV-24-0853	Page #: Page 11 of 33
	PER: 9535		

COR-AHS Cap Rail Allowable Span

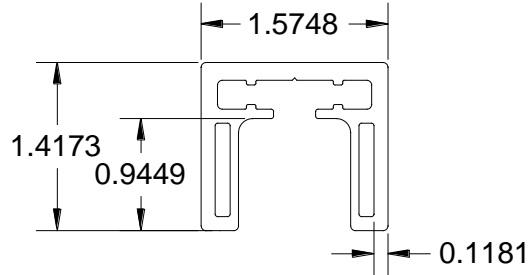

Area = 0.8134 in²
 Perim. = 13.9414 in
 Ixx = 0.1621 in⁴
 Iyy = 0.2794 in⁴
 rxx = 0.4464 in
 ryy = 0.5861 in
 Cxx = 0.7874 in
 Cyy = 0.5723 in
 Sxx = 0.2832 in³
 Syy = 0.3548 in³
 t = 0.1181 in
 w = 0.70865 in
 Material = Aluminum
 Fy = 37 ksi
 Fu = 42 ksi

$$F_{cr} = \frac{\pi^2 k \eta E_o}{12(1-\mu^2)(w/t)^2}$$

η (Plasticity Reduction Factor) = 0.62 (Table A6a)
 K (plate buckling coef.) = 3.50 (Section 2)
 E_o = 10100 ksi
 μ (Poisson's Ratio) = 0.33 (Elastic Range)

$$\eta = \sqrt{\frac{E_t}{E_o}}$$

F_{cr} = 562.17 ksi

Project Description: Glass Warehouse/Future Glass ARA-BPSQ Spigot Engineering Analysis	Date: February 11, 2025	Customer: Glass Warehouse/Future Glass	
	Engineer: SH	Project #: EEV-24-0853	
		PER: 9535	Page #: Page 12 of 33

$$M_n = 1.25S_eF_y$$

$$M_n \text{ Vertical Load} = 13.1000 \text{ k-in}$$

$$M_n \text{ Horizontal Load} = 16.4113 \text{ k-in}$$

$$M_{nult} = S_eF_{cr}$$

$$M_{ULT} \text{ Vertical Load} = 159.2321 \text{ k-in}$$

$$M_{ULT} \text{ Horizontal Load} = 199.4814 \text{ k-in}$$

Simply Supported Rail

$$M_w = wL^2/10$$

$$L_{\text{uniform Vert.}} = 177.31 \text{ in}$$

$$L_{\text{uniform Horiz.}} = 198.46 \text{ in}$$

$$M_c = PL/5$$

$$L_{\text{concentrated vert.}} = 327.50 \text{ in}$$

$$L_{\text{concentrated horiz.}} = 410.28 \text{ in}$$

Allowable Rail Span =	177	in =	14.75	ft
-----------------------	-----	------	-------	----

Cantilever Supported Rail

$$M_{wc} = wL^2/2$$

$$L_{\text{uniform Vert.}} = 79.30 \text{ in}$$

$$L_{\text{uniform Horiz.}} = 88.75 \text{ in}$$

$$M_{cc} = PL$$

$$L_{\text{concentrated vert.}} = 65.50 \text{ in}$$

$$L_{\text{concentrated horiz.}} = 82.06 \text{ in}$$

Allowable Rail Span =	65	in =	5.42	ft
-----------------------	----	------	------	----

Project Description: Glass Warehouse/Future Glass ARA-BPSQ Spigot Engineering Analysis	Date: February 11, 2025	Customer: Glass Warehouse/Future Glass	
		Project #: EEV-24-0853	
	Engineer: SH	PER: 9535	Page #: Page 13 of 33

R7 DRA-AHR42 Cap Rail Allowable Span

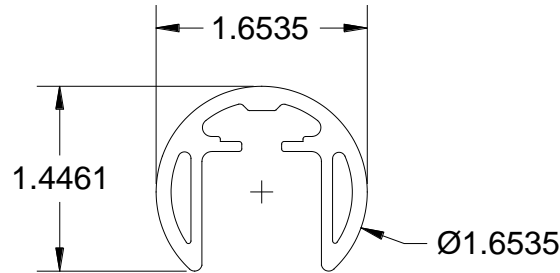

Area = 0.7087 in²
 Perim. = 11.598 in
 Ixx = 0.1141 in⁴
 Iyy = 0.2143 in⁴
 rxx = 0.4012 in
 ryy = 0.5499 in
 Cxx = 0.8277 in
 Cyy = 0.8015 in
 Sxx = 0.1424 in³
 Syy = 0.2589 in³
 t = 0.1181 in
 w = 0.72305 in
 Material = Aluminum
 Fy = 37 ksi
 Fu = 42 ksi

$$F_{cr} = \frac{\pi^2 k \eta E_o}{12(1-\mu^2)(w/t)^2}$$

η (Plasticity Reduction Factor) = 0.62 (Table A6a)
 K (plate buckling coef.) = 4 (Section 2)
 E_o = 10100 ksi
 μ (Poisson's Ratio) = 0.33 (Elastic Range)

$$\eta = \sqrt{\frac{E_t}{E_o}}$$

F_{cr} = 616.78 ksi

Project Description: Glass Warehouse/Future Glass ARA-BPSQ Spigot Engineering Analysis	Date: February 11, 2025	Customer: Glass Warehouse/Future Glass	
	Engineer: SH	Project #: EEV-24-0853	
		PER: 9535	Page #: Page 14 of 33



$$M_n = 1.25S_eF_y$$

$$M_{n \text{ Vertical Load}} = 6.5841 \text{ k-in}$$

$$M_{n \text{ Horizontal Load}} = 11.9746 \text{ k-in}$$

$$M_{nult} = S_eF_{cr}$$

$$M_{ULT \text{ Vertical Load}} = 87.8032 \text{ k-in}$$

$$M_{ULT \text{ Horizontal Load}} = 159.6899 \text{ k-in}$$

Simply Supported Rail

$$M_w = wL^2/10$$

$$L_{\text{uniform Vert.}} = 125.70 \text{ in}$$

$$L_{\text{uniform Horiz.}} = 169.53 \text{ in}$$

$$M_c = PL/5$$

$$L_{\text{concentrated vert.}} = 164.60 \text{ in}$$

$$L_{\text{concentrated horiz.}} = 299.36 \text{ in}$$

$$\text{Allowable Rail Span} = 125 \text{ in} = 10.41667 \text{ ft}$$

Cantilever Supported Rail

$$M_{wc} = wL^2/2$$

$$L_{\text{uniform Vert.}} = 56.22 \text{ in}$$

$$L_{\text{uniform Horiz.}} = 75.81 \text{ in}$$

$$M_{cc} = PL$$

$$L_{\text{concentrated vert.}} = 32.92 \text{ in}$$

$$L_{\text{concentrated horiz.}} = 59.87 \text{ in}$$

$$\text{Allowable Rail Span} = 32 \text{ in} = 2.66667 \text{ ft}$$

Project Description: Glass Warehouse/Future Glass ARA-BPSQ Spigot Engineering Analysis	Date: February 11, 2025	Customer: Glass Warehouse/Future Glass	
		Project #: EEV-24-0853	
	Engineer: SH	PER: 9535	Page #: Page 15 of 33

R24 AGE-SHR42 Cap Rail Allowable Span

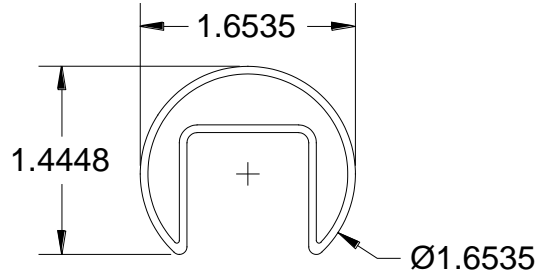

Area = 0.3905 in²
 Perim. = 13.2204 in
 Ixx = 0.0668 in⁴
 Iyy = 0.1178 in⁴
 rxx = 0.4135 in
 ryy = 0.5492 in
 Cxx = 0.8268 in
 Cyy = 0.7533 in
 Sxx = 0.0887 in³
 Syy = 0.1425 in³
 t = 0.059055 in
 w = 0.7224 in
 Material = 2205 Stainless Steel
 Fy = 65 ksi
 Fu = 90 ksi

$$F_{cr} = \frac{\pi^2 k \eta E_o}{12(1-\mu^2)(w/t)^2}$$

η (Plasticity Reduction Factor) = 0.62 (Table A6a)
 K (plate buckling coef.) = 4 (Section 2)
 E_o = 29000 ksi
 μ (Poisson's Ratio) = 0.3 (Elastic Range)

$$\eta = \sqrt{\frac{E_t}{E_o}}$$

F_{cr} = 434.40 ksi

Project Description: Glass Warehouse/Future Glass ARA-BPSQ Spigot Engineering Analysis	Date: February 11, 2025	Customer: Glass Warehouse/Future Glass	
	Engineer: SH	Project #: EEV-24-0853	
		PER: 9535	Page #: Page 16 of 33



$$M_n = 1.25 S_e F_y$$

M_n Vertical Load = 7.2050 k-in
 M_n Horizontal Load = 11.5763 k-in

$$M_{mult} = S_e F_{cr}$$

M_{ULT} Vertical Load = 38.5208 k-in
 M_{ULT} Horizontal Load = 61.8915 k-in

Simply Supported Rail

$$M_w = wL^2/10$$

$L_{uniform\ vert.}$ = 131.50 in
 $L_{uniform\ horiz.}$ = 166.68 in

$$M_c = PL/5$$

$L_{concentrated\ vert.}$ = 180.12 in
 $L_{concentrated\ horiz.}$ = 289.41 in

Allowable Rail Span = 131 in = 10.92 ft

Cantilever Supported Rail

$$M_{wc} = wL^2/2$$

$L_{uniform\ vert.}$ = 58.81 in
 $L_{uniform\ horiz.}$ = 74.54 in

$$M_{cc} = PL$$

$L_{concentrated\ vert.}$ = 36.02 in
 $L_{concentrated\ horiz.}$ = 57.88 in

Allowable Rail Span = 36 in = 3.00 ft

Project Description: Glass Warehouse/Future Glass ARA-BPSQ Spigot Engineering Analysis	Date: February 11, 2025	Customer: Glass Warehouse/Future Glass	
	Engineer: SH	Project #: EEV-24-0853	
		PER: 9535	Page #: Page 17 of 33

HG25S XS Cap Rail Allowable Span

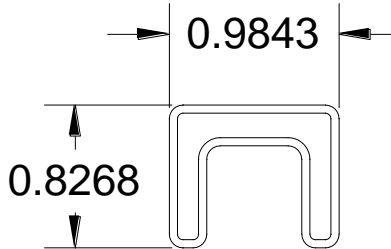

Area = 0.2071 in²
 Perim. = 8.7687 in
 Ixx = 0.0143 in⁴
 Iyy = 0.0261 in⁴
 rxx = 0.2629 in
 ryy = 0.3548 in
 Cxx = 0.4921 in
 Cyy = 0.4685 in
 Sxx = 0.0305 in³
 Syy = 0.0530 in³
 t = 0.0472 in
 w = 0.4134 in

Material = 2205 Stainless Steel

Fy = 65 ksi
 Fu = 90 ksi

$$F_{cr} = \frac{\pi^2 k \eta E_o}{12(1-\mu^2)(w/t)^2}$$

η (Plasticity Reduction Factor) = 0.62 (Table A6a)

K (plate buckling coef.) = 4 (Section 2)

E_o = 29000 ksi

μ (Poisson's Ratio) = 0.3 (Elastic Range)

$$\eta = \sqrt{\frac{E_t}{E_o}}$$

F_{cr} = 847.36 ksi

Project Description: Glass Warehouse/Future Glass ARA-BPSQ Spigot Engineering Analysis	Date: February 11, 2025	Customer: Glass Warehouse/Future Glass	
	Engineer: SH	Project #: EEV-24-0853	
		PER: 9535	Page #: Page 18 of 33



$$M_n = 1.25S_eF_y$$

$$M_n \text{ Vertical Load} = 2.4800 \text{ k-in}$$

$$M_n \text{ Horizontal Load} = 4.3093 \text{ k-in}$$

$$M_{nult} = S_eF_{cr}$$

$$M_{ULT} \text{ Vertical Load} = 25.8640 \text{ k-in}$$

$$M_{ULT} \text{ Horizontal Load} = 44.9425 \text{ k-in}$$

Simply Supported Rail

$$M_w = wL^2/10$$

$$L_{\text{uniform Vert.}} = 77.15 \text{ in}$$

$$L_{\text{uniform Horiz.}} = 101.70 \text{ in}$$

$$M_c = PL/5$$

$$L_{\text{concentrated vert.}} = 62.00 \text{ in}$$

$$L_{\text{concentrated horiz.}} = 107.73 \text{ in}$$

Allowable Rail Span =	61	in =	5.08	ft
-----------------------	----	------	------	----

Cantilever Supported Rail

$$M_{wc} = wL^2/2$$

$$L_{\text{uniform Vert.}} = 34.50 \text{ in}$$

$$L_{\text{uniform Horiz.}} = 45.48 \text{ in}$$

$$M_{cc} = PL$$

$$L_{\text{concentrated vert.}} = 12.40 \text{ in}$$

$$L_{\text{concentrated horiz.}} = 21.55 \text{ in}$$

Allowable Rail Span =	12	in =	1.00	ft
-----------------------	----	------	------	----

Project Description: Glass Warehouse/Future Glass ARA-BPSQ Spigot Engineering Analysis	Date: February 11, 2025	Customer: Glass Warehouse/Future Glass	
	Engineer: SH	Project #: EEV-24-0853	
		PER: 9535	Page #: Page 19 of 33

R15 MAT-SHS Cap Rail Allowable Span

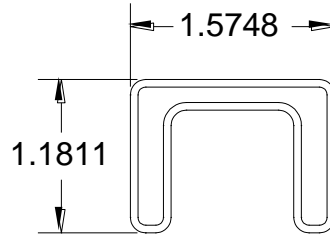

Area = 0.4022 in²
 Perim. = 13.621 in
 Ixx = 0.0588 in⁴
 Iyy = 0.1302 in⁴
 rxx = 0.3824 in
 ryy = 0.569 in
 Cxx = 0.7874 in
 Cyy = 0.7041 in
 Sxx = 0.0835 in³
 Syy = 0.1654 in³
 t = 0.0591 in
 w = 0.59055 in

Material = 2205 Stainless Steel

Fy = 65 ksi
 Fu = 90 ksi

$$F_{cr} = \frac{\pi^2 k \eta E_0}{12(1-\mu^2)(w/t)^2}$$

η (Plasticity Reduction Factor) = 0.62 (Table A6a)
 K (plate buckling coef.) = 4 (Section 2)
 E₀ = 29000 ksi
 μ (Poisson's Ratio) = 0.3 (Elastic Range)

$$\eta = \sqrt{\frac{E_t}{E_o}}$$

F_{cr} = 651.01 ksi

Project Description: Glass Warehouse/Future Glass ARA-BPSQ Spigot Engineering Analysis	Date: February 11, 2025	Customer: Glass Warehouse/Future Glass	
		Project #: EEV-24-0853	
	Engineer: SH	PER: 9535	Page #: Page 20 of 33



$$M_n = 1.25S_eF_y$$

$$M_n \text{ Vertical Load} = 6.7853 \text{ k-in}$$

$$M_n \text{ Horizontal Load} = 13.4350 \text{ k-in}$$

$$M_{nult} = S_eF_{cr}$$

$$M_{ULT} \text{ Vertical Load} = 54.3665 \text{ k-in}$$

$$M_{ULT} \text{ Horizontal Load} = 107.6475 \text{ k-in}$$

Simply Supported Rail

$$M_w = wL^2/10$$

$$L_{\text{uniform Vert.}} = 127.61 \text{ in}$$

$$L_{\text{uniform Horiz.}} = 179.57 \text{ in}$$

$$M_c = PL/5$$

$$L_{\text{concentrated vert.}} = 169.63 \text{ in}$$

$$L_{\text{concentrated horiz.}} = 335.88 \text{ in}$$

Allowable Rail Span =	127	in =	10.58	ft
-----------------------	-----	------	-------	----

Cantilever Supported Rail

$$M_{wc} = wL^2/2$$

$$L_{\text{uniform Vert.}} = 57.07 \text{ in}$$

$$L_{\text{uniform Horiz.}} = 80.30 \text{ in}$$

$$M_{cc} = PL$$

$$L_{\text{concentrated vert.}} = 33.93 \text{ in}$$

$$L_{\text{concentrated horiz.}} = 67.18 \text{ in}$$

Allowable Rail Span =	33	in =	2.75	ft
-----------------------	----	------	------	----

Project Description: Glass Warehouse/Future Glass ARA-BPSQ Spigot Engineering Analysis	Date: February 11, 2025	Customer: Glass Warehouse/Future Glass	
	Engineer: SH	Project #: EEV-24-0853	
		PER: 9535	Page #: Page 21 of 33



YOU ENVISION IT – WE ENGINEER IT

1900 NE Miami Ct., Ste. 2-15
Miami, FL 33132
TEL: 954.399-8478 | FAX: 954.744.4738
WEB: www.buildingdrops.com

APPENDIX

Project Description: Glass Warehouse/Future Glass ARA-BPSQ Spigot Engineering Analysis	Date: February 11, 2025	Customer: Glass Warehouse/Future Glass	
		Project #: EEV-24-0853	
	Engineer: SH	PER: 9535	Page #: Page 22 of 33



Determination of moment and amplification factors

Glass Panel Width: 36 in Uniform Load: 50 plf

Height	36	42	48	60
Mave (lb-in)	1800	2100	2400	3000
Calculated Stress (psi)	4090.90	4772.72	5454.54	6818.17
Stress by FEA (psi)	8729	10250	11920	15110
β	2.1338	2.1476	2.1853	2.2161
Calculated Defl. (in.)	0.7246	1.1506	1.7175	3.3545
Defl. by FEA (in.)	0.726	1.153	1.720	3.358
λ	1.00196	1.00208	1.00144	1.00103

Glass Panel Width: 36 in Wind Load: 10 PSF

Height	36	42	48	60
Mave (lb-in)	540	735	960	1500
Calculated Stress (psi)	1227.27	1670.45	2181.81	3409.08
Stress by FEA (psi)	2431	3358	4512	7213
β	1.9808	2.0102	2.0680	2.1158
Calculated Defl. (in.)	0.1630	0.3020	0.5153	1.2580
Defl. by FEA (in.)	0.162	0.300	0.513	1.255
λ	0.9937	0.9933	0.9956	0.9977

Project Description: Glass Warehouse/Future Glass ARA-BPSQ Spigot Engineering Analysis	Date: February 11, 2025	Customer: Glass Warehouse/Future Glass	
	Engineer: SH	Project #: EEV-24-0853	
		PER: 9535	Page #: Page 23 of 33



YOU ENVISION IT – WE ENGINEER IT

1900 NE Miami Ct., Ste. 2-15
 Miami, FL 33132
 TEL: 954.399-8478 | FAX: 954.744.4738
 WEB: www.buildingdrops.com

Glass Panel Width: 48 in Uniform Load: 50 plf

Height	36	42	48	60
Mave (lb-in)	1800	2100	2400	3000
Calculated Stress (psi)	4090.90	4772.72	5454.54	6818.17
Stress by FEA (psi)	11080	13150	15300	19280
β	2.7084	2.7552	2.8050	2.8277
Calculated Defl. (in.)	0.7246	1.1506	1.7175	3.3545
Defl. by FEA (in.)	0.823	1.288	1.901	3.646
λ	1.1358	1.1194	1.1068	1.0869

Glass Panel Width: 48 in Wind Load: 10 PSF

Height	36	42	48	60
Mave (lb-in)	540	735	960	1500
Calculated Stress (psi)	1227.27	1670.45	2181.81	3409.08
Stress by FEA (psi)	3109	4344	5820	9257
β	2.5333	2.6005	2.6675	2.7154
Calculated Defl. (in.)	0.1630	0.3020	0.5153	1.2580
Defl. by FEA (in.)	0.187	0.342	0.578	1.388
λ	1.1470	1.1323	1.1218	1.1034

Project Description: Glass Warehouse/Future Glass ARA-BPSQ Spigot Engineering Analysis	Date: February 11, 2025	Customer: Glass Warehouse/Future Glass	
	Engineer: SH	Project #: EEV-24-0853	
		PER: 9535	Page #: Page 24 of 33



YOU ENVISION IT – WE ENGINEER IT

1900 NE Miami Ct., Ste. 2-15
 Miami, FL 33132
 TEL: 954.399-8478 | FAX: 954.744.4738
 WEB: www.buildingdrops.com

Glass Panel Width: 60 in Uniform Load: 50 plf

Height	36	42	48	60
Mave (lb-in)	1800	2100	2400	3000
Calculated Stress (psi)	4090.90	4772.72	5454.54	6818.17
Stress by FE A (psi)	13700	16140	18690	23550
β	3.3489	3.3817	3.4265	3.4540
Calculated Defl. (in.)	0.7246	1.1506	1.7175	3.3545
Defl. by FE A (in.)	0.932	1.442	2.106	3.978
λ	1.2863	1.2532	1.2262	1.1859

Glass Panel Width: 60 in Wind Load: 10 PSF

Height	36	42	48	60
Mave (lb-in)	540	735	960	1500
Calculated Stress (psi)	1227.27	1670.45	2181.81	3409.08
Stress by FE A (psi)	3861	5350	7132	11330
β	3.1460	3.2027	3.2688	3.3235
Calculated Defl. (in.)	0.1630	0.3020	0.5153	1.2580
Defl. by FE A (in.)	0.215	0.390	0.652	1.539
λ	1.3188	1.2912	1.2654	1.2234

Project Description: Glass Warehouse/Future Glass ARA-BPSQ Spigot Engineering Analysis	Date: February 11, 2025	Customer: Glass Warehouse/Future Glass	
	Engineer: SH	Project #: EEV-24-0853	
		PER: 9535	Page #: Page 25 of 33



YOU ENVISION IT – WE ENGINEER IT

1900 NE Miami Ct., Ste. 2-15
 Miami, FL 33132
 TEL: 954.399-8478 | FAX: 954.744.4738
 WEB: www.buildingdrops.com

Glass Panel Width: 68 in Uniform Load: 50 plf

Height	36	42	48	60
Mave (lb-in)	1800	2100	2400	3000
Calculated Stress (psi)	4090.90	4772.72	5454.54	6818.17
Stress by FEA (psi)	15430	18150	21020	26470
β	3.7718	3.8029	3.8537	3.8823
Calculated Defl. (in.)	0.7246	1.1506	1.7175	3.3545
Defl. by FEA (in.)	1.01	1.552	2.254	4.219
λ	1.3939	1.3488	1.3124	1.2577

Glass Panel Width: 68 in Wind Load: 10 PSF

Height	36	42	48	60
Mave (lb-in)	540	735	960	1500
Calculated Stress (psi)	1227.27	1670.45	2181.81	3409.08
Stress by FEA (psi)	4355	6029	8031	11330
β	3.5485	3.6092	3.6809	3.3235
Calculated Defl. (in.)	0.1630	0.3020	0.5153	1.2580
Defl. by FEA (in.)	0.238	0.423	0.704	1.648
λ	1.4598	1.4005	1.3663	1.3101

Project Description: Glass Warehouse/Future Glass ARA-BPSQ Spigot Engineering Analysis	Date: February 11, 2025	Customer: Glass Warehouse/Future Glass	
	Engineer: SH	Project #: EEV-24-0853	
		PER: 9535	Page #: Page 26 of 33



YOU ENVISION IT – WE ENGINEER IT

1900 NE Miami Ct., Ste. 2-15
 Miami, FL 33132
 TEL: 954.399-8478 | FAX: 954.744.4738
 WEB: www.buildingdrops.com

Glass Panel Width: 72 in Uniform Load: 50 pif

Height	36	42	48	60
Mave (lb-in)	1800	2100	2400	3000
Calculated Stress (psi)	4090.90	4772.72	5454.54	6818.17
Stress by FEA (psi)	16300	19170	22190	27940
β	3.9845	4.0166	4.0682	4.0979
Calculated Defl. (in.)	0.7246	1.1506	1.7175	3.3545
Defl. by FEA (in.)	1.05	1.609	2.331	4.344
λ	1.4491	1.3984	1.3572	1.2950

Glass Panel Width: 72 in Wind Load: 10 PSF

Height	36	42	48	60
Mave (lb-in)	540	735	960	1500
Calculated Stress (psi)	1227.27	1670.45	2181.81	3409.08
Stress by FEA (psi)	4603	6370	8483	13470
β	3.7506	3.8133	3.8880	3.9512
Calculated Defl. (in.)	0.1630	0.3020	0.5153	1.2580
Defl. by FEA (in.)	0.25	0.441	0.730	1.704
λ	1.5335	1.4601	1.4168	1.3546

Project Description: Glass Warehouse/Future Glass ARA-BPSQ Spigot Engineering Analysis	Date: February 11, 2025	Customer: Glass Warehouse/Future Glass	
	Engineer: SH	Project #: EEV-24-0853	
		PER: 9535	Page #: Page 27 of 33



Determination of Effective Thickness of Laminated Glass

3/16 + 0.06 PVB + 3/16 = 7/16 Laminated Glass

Glass Ply 1 Nominal Thickness: 3/16 in
 Glass Ply 2 Nominal Thickness: 3/16 in
 Interlayer Type: PVB
 Interlayer Complex Shear Modulus: 70 psi

Laminate Nominal Thickness: 7/16 in
 Glass Temper: Fully Tempered:

Glass Ply 1 min. Thickness (h1): 0.18 in
 Glass Ply 2 min. Thickness (h2): 0.18 in
 Interlayer Thickness (hv): 0.060 in

Laminate Minimum Thickness (hs): 0.240 in
 Ply 1 weighted Thickness (hs1): 0.120 in
 Ply 2 weighted Thickness (hs2): 0.120 in

Glass Inertia (Is): 0.0052 in³

Height Dimension (in)	Shear Transfer Coefficient (Γ)	Effective Thickness for Deflection (h _{ef} ;w)	Effective thickness for Bending (h ₁ ;e _f ;σ)	Effective thickness for Bending (h ₂ ;e _f ;σ)
24	0.070	0.252	0.285	0.285
30	0.105	0.263	0.298	0.298
36	0.144	0.274	0.310	0.310
42	0.186	0.285	0.322	0.322
48	0.230	0.296	0.332	0.332
54	0.275	0.306	0.342	0.342
60	0.319	0.316	0.350	0.350
66	0.361	0.324	0.358	0.358
72	0.402	0.332	0.364	0.364

Project Description: Glass Warehouse/Future Glass ARA-BPSQ Spigot Engineering Analysis	Date: February 11, 2025	Customer: Glass Warehouse/Future Glass	
	Engineer: SH	Project #: EEV-24-0853	
	PER: 9535	Page #: Page 28 of 33	



3/16 + 0.06 PVB ES + 3/16 = 7/16 Laminated Glass

Glass Ply 1 Nominal Thickness: 3/16 in
 Glass Ply 2 Nominal Thickness: 3/16 in
 Interlayer Type: PVB ES
 Interlayer Complex Shear Modulus: 246.56 psi

Laminate Nominal Thickness: 7/16 in
 Glass Temper: Fully Tempered:

Glass Ply 1 min. Thickness (h1): 0.18 in
 Glass Ply 2 min. Thickness (h2): 0.18 in
 Interlayer Thickness (hv): 0.060 in

Laminate Minimum Thickness (hs): 0.240 in
 Ply 1 weighted Thickness (hs1): 0.120 in
 Ply 2 weighted Thickness (hs2): 0.120 in

Glass Inertia (Is): 0.0052 in³

Height Dimension (in)	Shear Transfer Coefficient (Γ)	Effective Thickness for Deflection (hef,w)	Effective thickness for Bending (h1;ef,σ)	Effective thickness for Bending (h2;ef,σ)
24	0.208	0.291	0.327	0.327
30	0.292	0.310	0.345	0.345
36	0.372	0.327	0.360	0.360
42	0.447	0.340	0.371	0.371
48	0.513	0.352	0.379	0.379
54	0.571	0.361	0.386	0.386
60	0.622	0.369	0.391	0.391
66	0.666	0.376	0.395	0.395
72	0.703	0.381	0.399	0.399

Project Description: Glass Warehouse/Future Glass ARA-BPSQ Spigot Engineering Analysis	Date: February 11, 2025	Customer: Glass Warehouse/Future Glass	
		Project #: EEV-24-0853	
	Engineer: SH	PER: 9535	Page #: Page 29 of 33



3/16 + 0.06 SGP + 3/16 = 7/16 Laminated Glass

Glass Ply 1 Nominal Thickness: 3/16 in
 Glass Ply 2 Nominal Thickness: 3/16 in
 Interlayer Type: SGP
 Interlayer Complex Shear Modulus: 1638.9 psi

Laminate Nominal Thickness: 7/16 in
 Glass Temper: Fully Tempered:

Glass Ply 1 min. Thickness (h1): 0.18 in
 Glass Ply 2 min. Thickness (h2): 0.18 in
 Interlayer Thickness (hv): 0.060 in

Laminate Minimum Thickness (hs): 0.240 in
 Ply 1 weighted Thickness (hs1): 0.120 in
 Ply 2 weighted Thickness (hs2): 0.120 in

Glass Inertia (Is): 0.0052 in⁴

Height Dimension (in)	Shear Transfer Coefficient (Γ)	Effective Thickness for Deflection (hef;w)	Effective thickness for Bending (h1;ef;σ)	Effective thickness for Bending (h2;ef;σ)
24	0.636	0.372	0.393	0.393
30	0.732	0.385	0.401	0.401
36	0.798	0.394	0.406	0.406
42	0.843	0.400	0.410	0.410
48	0.875	0.404	0.412	0.412
54	0.899	0.407	0.413	0.413
60	0.916	0.410	0.414	0.414
66	0.930	0.411	0.415	0.415
72	0.940	0.412	0.416	0.416

Project Description: Glass Warehouse/Future Glass ARA-BPSQ Spigot Engineering Analysis	Date: February 11, 2025	Customer: Glass Warehouse/Future Glass	
	Engineer: SH	Project #: EEV-24-0853	
		PER: 9535	Page #: Page 30 of 33



1/4 + 0.06 PVB + 1/4 = 9/16 Laminated Glass

Glass Ply 1 Nominal Thickness: 1/4 in
 Glass Ply 2 Nominal Thickness: 1/4 in
 Interlayer Type: PVB
 Interlayer Complex Shear Modulus: 70 psi

Laminate Nominal Thickness: 9/16 in
 Glass Temper: Fully Tempered:

Glass Ply 1 min. Thickness (h1): 0.219 in
 Glass Ply 2 min. Thickness (h2): 0.219 in
 Interlayer Thickness (hv): 0.060 in

Laminate Minimum Thickness (hs): 0.279 in
 Ply 1 weighted Thickness (hs1): 0.140 in
 Ply 2 weighted Thickness (hs2): 0.140 in

Glass Inertia (Is): 0.0085 in³

Height Dimension (in)	Shear Transfer Coefficient (Γ)	Effective Thickness for Deflection (h _{ef} ;w)	Effective thickness for Bending (h ₁ ;e _f ;σ)	Effective thickness for Bending (h ₂ ;e _f ;σ)
24	0.058	0.300	0.338	0.338
30	0.088	0.311	0.351	0.351
36	0.121	0.322	0.364	0.364
42	0.158	0.334	0.376	0.376
48	0.197	0.345	0.388	0.388
54	0.237	0.356	0.399	0.399
60	0.278	0.367	0.408	0.408
66	0.317	0.377	0.417	0.417
72	0.356	0.386	0.425	0.425

Project Description: Glass Warehouse/Future Glass ARA-BPSQ Spigot Engineering Analysis	Date: February 11, 2025	Customer: Glass Warehouse/Future Glass	
		Project #: EEV-24-0853	
	Engineer: SH	PER: 9535	Page #: Page 31 of 33



1/4 + 0.06 PVB ES + 1/4 = 9/16 Laminated Glass

Glass Ply 1 Nominal Thickness: 1/4 in
 Glass Ply 2 Nominal Thickness: 1/4 in
 Interlayer Type: PVB ES
 Interlayer Complex Shear Modulus: 246.56 psi

Laminate Nominal Thickness: 9/16 in
 Glass Temper: Fully Tempered:

Glass Ply 1 min. Thickness (h1): 0.219 in
 Glass Ply 2 min. Thickness (h2): 0.219 in
 Interlayer Thickness (hv): 0.060 in

Laminate Minimum Thickness (hs): 0.279 in
 Ply 1 weighted Thickness (hs1): 0.140 in
 Ply 2 weighted Thickness (hs2): 0.140 in

Glass Inertia (Is): 0.0085 in³

Height Dimension (in)	Shear Transfer Coefficient (Γ)	Effective Thickness for Deflection (hef;w)	Effective thickness for Bending (h1;ef,σ)	Effective thickness for Bending (h2;ef,σ)
24	0.178	0.340	0.382	0.382
30	0.253	0.361	0.402	0.402
36	0.328	0.379	0.419	0.419
42	0.399	0.395	0.433	0.433
48	0.464	0.409	0.443	0.443
54	0.523	0.421	0.452	0.452
60	0.575	0.431	0.459	0.459
66	0.621	0.439	0.464	0.464
72	0.661	0.446	0.469	0.469

Project Description: Glass Warehouse/Future Glass ARA-BPSQ Spigot Engineering Analysis	Date: February 11, 2025	Customer: Glass Warehouse/Future Glass	
	Engineer: SH	Project #: EEV-24-0853	
		PER: 9535	Page #: Page 32 of 33



1/4 + 0.06 SGP + 1/4 = 9/16 Laminated Glass

Glass Ply 1 Nominal Thickness: 1/4 in
 Glass Ply 2 Nominal Thickness: 1/4 in
 Interlayer Type: SGP
 Interlayer Complex Shear Modulus: 1638.9 psi

Laminate Nominal Thickness: 9/16 in
 Glass Temper: Fully Tempered:

Glass Ply 1 min. Thickness (h1): 0.219 in
 Glass Ply 2 min. Thickness (h2): 0.219 in
 Interlayer Thickness (hv): 0.060 in

Laminate Minimum Thickness (hs): 0.279 in
 Ply 1 weighted Thickness (hs1): 0.140 in
 Ply 2 weighted Thickness (hs2): 0.140 in

Glass Inertia (Is): 0.0085 in³

Height Dimension (in)	Shear Transfer Coefficient (Γ)	Effective Thickness for Deflection (hef;w)	Effective thickness for Bending (h1;ef;σ)	Effective thickness for Bending (h2;ef;σ)
24	0.590	0.433	0.461	0.461
30	0.692	0.451	0.472	0.472
36	0.764	0.463	0.479	0.479
42	0.815	0.471	0.484	0.484
48	0.852	0.476	0.487	0.487
54	0.879	0.481	0.489	0.489
60	0.900	0.484	0.490	0.490
66	0.916	0.486	0.492	0.492
72	0.928	0.488	0.493	0.493

Project Description: Glass Warehouse/Future Glass ARA-BPSQ Spigot Engineering Analysis	Date: February 11, 2025	Customer: Glass Warehouse/Future Glass	
		Project #: EEV-24-0853	
	Engineer: SH	PER: 9535	Page #: Page 33 of 33