

Ecostat Classic
Thermostatic Trim with Volume Control and Diverter, Square
 Finishes : **brushed nickel** Part no. : **15728821**



Description

Features

- Volume control and diverter for 2 outlets
- Flow: 6.0 GPM (22.7 L/Min)
- Thermostatic cartridge, Shut-off/ diverter valve
- Anti-scald 100° safety stop
- Optimized for water-efficient shower products

Item details

List Price \$ 693.00

Compliance

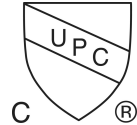

Product image



Scale drawing

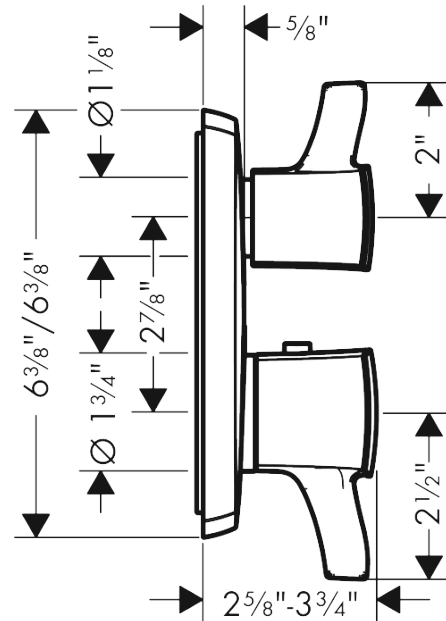

Ecostat Classic
Thermostatic Trim with Volume Control and Diverter, Square
 Finishes : **brushed nickel** Part no. : **15728821**



Exploded drawing

Year of production: >01/19

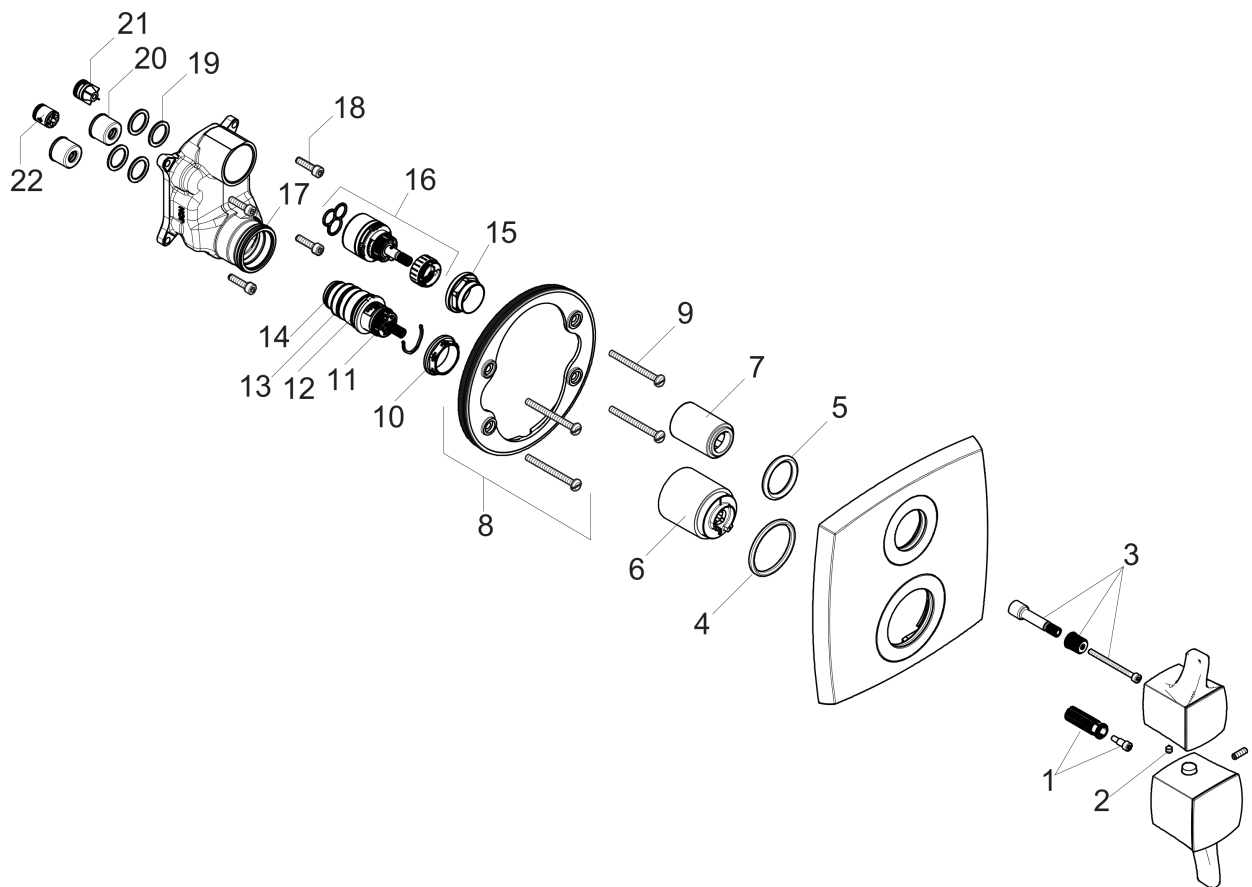

Ecostat Classic
Thermostatic Trim with Volume Control and Diverter, Square
 Finishes : **brushed nickel** Part no. : **15728821**



Spare parts list

Year of production: >01/19

Pos.	Description	Part no.	Price	PU
1	handle fixing set	95843000	-	1
2	hollow set screw M4x5	92846000	-	1
3	adapter for handle	95252000	-	1
4	O-ring 44x4	98471000	-	1
5	O-ring 30x5	98153000	-	1
6	sleeve	92216820	-	1
7	sleeve	96446820	-	1
8	holder for escutcheon	98793000	-	1
9	set of fixing screws	96454000	-	1
10	nut	98913000	-	1
11	thermostat cartridge	98282000	-	1
12	O-ring 25x2,5	92146000	-	1
13	O-ring 25x1,5	98146000	-	1
14	O-ring 20x1,5	98197000	-	1
15	nut	95255000	-	1
16	shut off unit with selector	98283000	-	1
17	O-ring 36x2	98156000	-	1
18	set of screws	96525000	-	1
19	O-ring 16x2	98133000	-	1
20	noise reduction	94073000	-	1
21	set of non return valves DW 15	97350000	-	1
22	non return valve (pressure-resistant up to 2 MPa)	92594000	-	1
a	compensation set 1°	95521000	-	1
b	extension 25 mm	13595000	-	1
c	set of fixing screws	97747000	-	1