

SIDES

BOTTOM

UL File #

E22445

Material: Aluminum Powder Coating Silver Grey

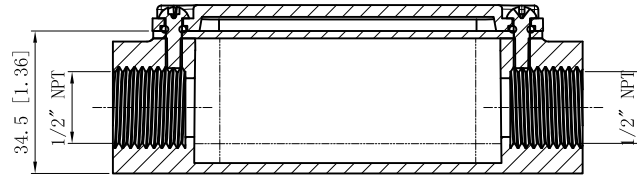
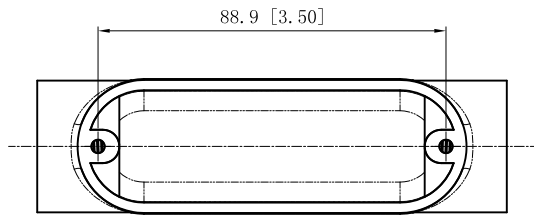

CUTAWAY VIEW A-A

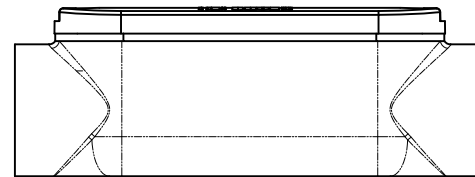
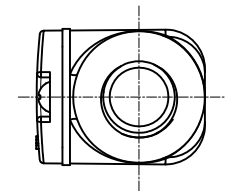
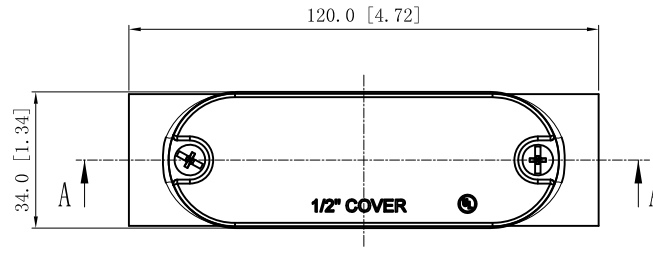
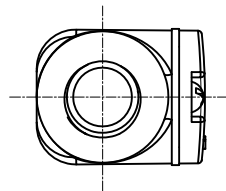
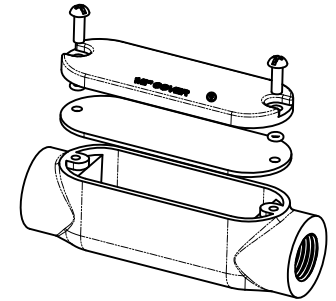

This data sheet is for reference only .GARVIN INDUSTRIES reserves the right to make changes to the design without prior notice.

DESCRIPTION
TRADE REFERENCE TERMS

STANDARD PACKING
10 PCS

TITLE		GARVIN INDUSTRIES	
TITLE		"LC" ALUMINUM CONDUIT BODY	
SIZE	DWG NO.	LC50	REV
A4		DATA SHEET	