

BOSS[®]
AUDIO SYSTEMS

 **Bluetooth**[®]

FULLY
AMPLIFIED

B82ABT **USER MANUAL**
QUICK START GUIDE
8" (203 mm) 2-WAY AMPLIFIED MARINE GRADE
ROLL CAGE/WAKETOWER SPEAKER PODS
FEATURING BLUETOOTH[®] CONTROLLER AND BUILT-IN AMPLIFIER



1

Thank you for purchasing this

BOSS[®]
AUDIO SYSTEMS

B82ABT All Terrain Sound System

Please read through these instructions carefully so you will know how to operate your model properly.

After you have finished reading the instructions, keep this document in a safe place for future reference.

THIS PACKAGE CONTAINS

- 2- B82ABT Marine Waketower Speaker System (1 Active + 1 Passive)
- 1- Bluetooth Multi-Function Controller
- 1- Handlebar Mounting Kit for Bluetooth Controller
- 1- Mounting Bracket Kit
- 1- Power Wire Harness Kit
- 2- Security Rope
- 1- User Manual Quick Start Guide / Poster
- 1- Warranty Card

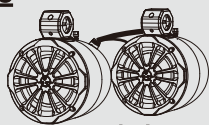

INFORMATION TO THE USER



The Bluetooth[®] word mark and logos are registered trademarks owned by Bluetooth SIG, Inc. and any use of such marks by BOSS Audio Systems is under license. Other trademarks and trade names are those of their respective owners.

FCC COMPLIANCE STATEMENT

This device complies with part 15 of the FCC Rules. Operation is subject to the following two conditions:

- (1) this device may not cause interference, and
- (2) this device must accept any interference, including interference that may cause undesired operation of this device.

This transmitter must not be co-located or operated in conjunction with any other antenna or transmitter. The Bluetooth antenna cannot be removed (or replaced) by user. This equipment complies with FCC/ IC radiation exposure limits set forth for an uncontrolled environment and meets the FCC radio frequency (RF) Exposure Guidelines and RSS-102 of the IC radio frequency (RF) Exposure rules. This equipment has very low levels of RF energy that it deemed to comply without maximum permissive exposure (MPE) evaluation. But it is desirable that it should be installed and operated keeping the radiator at least 20 cm or more away from person's body (excluding extremities: hands, wrists, feet and ankles). Alteration or modifications carried out without appropriate authorization may invalidate the user's right to operate the equipment.

NOTE: This equipment has been tested and found to comply with the limits for a Class B digital device, pursuant to Part 15 of the FCC Rules. These limits are designed to provide reasonable protection against harmful interference in a residential installation. This equipment generates, uses and can radiate radio frequency energy and, if not installed and used in accordance with the instructions, may cause harmful interference to radio communications. However, there is no guarantee that interference will not occur in a particular installation. If this equipment does cause harmful interference to radio or television reception, which can be determined by turning the equipment off and on, the user is encouraged to try to correct the interference by one or more of the following measures:

- Relocate or reorient the receiving antenna.
- Increase the separation between the equipment and receiver.
- Connect the equipment into an outlet on a circuit different from that to which the receiver is connected.
- Consult the dealer or an experienced radio/TV technician for help.

CAUTION!!

**ADJUSTMENT OR ALTERATIONS OF THIS DEVICE MAY RESULT
IN HAZARDOUS RADIATION EXPOSURE.**



IMPORTANT SAFETY PRECAUTIONS

- Do not operate mobile equipment while driving a motorized vehicle – safe driving and safety consideration of others should always be your highest priority.
- In the event you should notice smoke, strange noises or odor from this product, or any other abnormal signs, immediately turn off the power and consult your dealer or the nearest authorized **BOSS AUDIO** Service Center. Using this product in this condition may result in permanent damage to the system.
- Set your volume control at a low setting, then slowly increase the sound until you can hear it comfortably without distortion, or ear discomfort.
- **BE SURE TO OBSERVE THE FOLLOWING GUIDELINES:**
 - Do not turn up the volume so high that you can't hear what's around you.
 - Use caution or temporarily discontinue use in potentially hazardous situations.

INSTALLATION PRECAUTIONS

WARNING - Always consult a professional installer





- Do not attempt to install or service this product by yourself. Installation or servicing of this product by persons without professional training and experience in electronic equipment and motorized vehicle accessories may be dangerous and could expose you to the risk of electric shock, injury or other hazards
- Refer any repairs to a qualified **BOSS AUDIO SYSTEMS** Service Center
- The **B82ABT** can be powered from a vehicles cigarette lighter / auxiliary power port, or hard wired directly to the battery through an optional relay / accessory switch
- When wiring directly to the vehicles battery, be sure to disconnect the battery negative terminal wire before starting any wiring procedures, it is suggested that an optional fuse and fuse holder (not included) with minimum rating of **20 Amps** be in line with the positive battery terminal
- The ground cable length should not exceed 18 inches (See wiring diagram)
- The **B82ABT** has a weather resistant design, it should not be submerged in or under water under any circumstances
- Use only the installation parts provided with the **B82ABT**

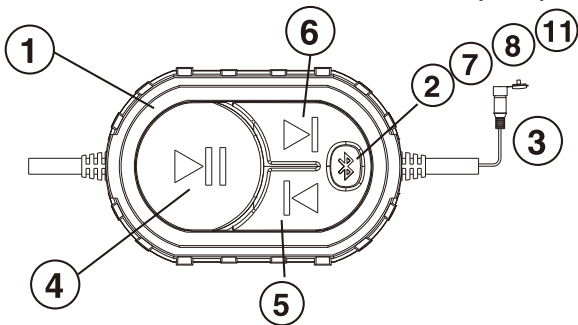

CAUTION!! Using other mounting methods may void this warranty



GETTING TO KNOW YOUR B82ABT MULTIFUNCTION CONTROLLER (MFC)

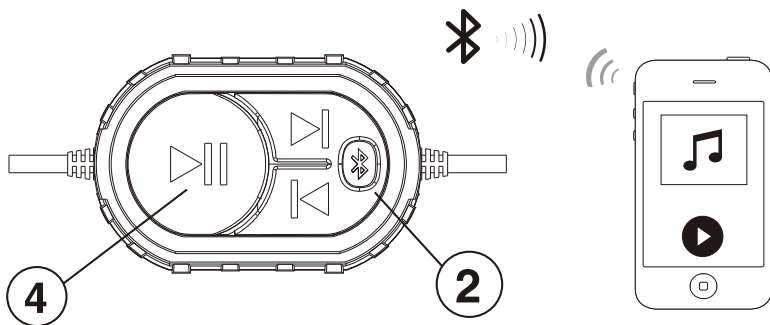

- 1 MFC - MULTIFUNCTION CONTROLLER
- 2 BLUETOOTH INDICATOR LED(BLUE) / AUX-IN STATUS INDICATOR(RED)
- 3 3.5mm AUX-INPUT
- 4 PLAY/PAUSE / Press and hold for POWER ON or OFF
- 5 PREVIOUS TRACK / Press and hold for VOL -
- 6 NEXT TRACK / Press and hold for VOL + /
Warning tone while up to maximum volume in Bluetooth mode
- 7 Disconnect the currently connected Bluetooth device by pressing  button for 4 seconds
- 8 Clear any paired Bluetooth device in memory by pressing  button for 8 seconds
- 9 Disconnect the currently connected Bluetooth device by turning off Bluetooth in your device setting menu
- 10 When powered on and no Bluetooth device is paired or connected, the blue lit  button flashes quickly for 10 minutes until powered off.
- 11 If the Bluetooth device is out of connection range, the Bluetooth pairing/connection will be automatically disconnected and the blue lit  button will flash quickly for 10 minutes until powered off.
- 12 When operation voltage is lower than 9.5Volt , MFC gives warning tone
- 13 MFC concludes tones of definition : Power On/Off , Bluetooth connection / Disconnection , Maximum volume, Lower voltage



PAIRING & DISCOVERING A NEW BLUETOOTH CONNECTION

1) Power on the **B82ABT** by pressing and holding down the  **Play/Pause** multifunction button for 3 seconds. The  blue LEDs will start to flash, signalling that the B82ABT is now ready for Bluetooth pairing.

NOTE: You have 30 seconds before you must restart this procedure over again.

2) Now that the **B82ABT** is in pairing mode:

ANDROID users:

- Go into the **Settings Menu** of your device
- Enter the **Bluetooth Menu**
- TURN ON Bluetooth** and press **SCAN**
- "BOSS AUDIO B82ABT"** will now be displayed under **AVAILABLE DEVICES**
- Press **"BOSS AUDIO B82ABT" to get Bluetooth connected**

iOS users:



- Go into the **Settings Menu** of your **iOS** device
- Enter the **Bluetooth Menu**
- TURN ON Bluetooth**
- "BOSS AUDIO B82ABT"** will now be displayed
- Press **"BOSS AUDIO B82ABT" to get Bluetooth connected**

3) If the **BOSS AUDIO B82ABT** is not seen, repeat the above steps to refresh the **"Device List"**

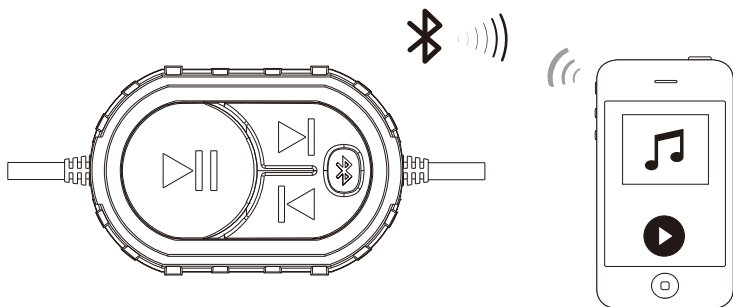
4) When the connection is successful, the  blue LED will turn to solid blue from flashing. You are now ready to stream music from your favorite media player to the **B82ABT**.



RECONNECTION

- 1) Power on the **B82ABT** and your last paired device Bluetooth.
- 2) The unit will now automatically reconnect. The  blue LED will turn to solid blue.
- 3) If your device was previously paired with the **B82ABT** , but it wasn't the last paired device:
 - a. Ensure no other devices are currently paired
 - b. Enter the **Bluetooth Menu** on your device being paired
 - c. "**BOSS AUDIO B82ABT**" will display under **AVAILABLE DEVICES**
 - d. Choose the "**BOSS AUDIO B82ABT**" to reconnect
- 4) If the device is out of range from the **B82ABT** , it will disconnect automatically and the  blue LED will flash.
If the device is back in range within 10 minutes, the **B82ABT** will reconnect to the device. Otherwise, the  blue LED will keep flashing for 10 minutes until powered off.





Tips:

To avoid battery exhaustion, be sure to occasionally run the vehicles engine while using this product.

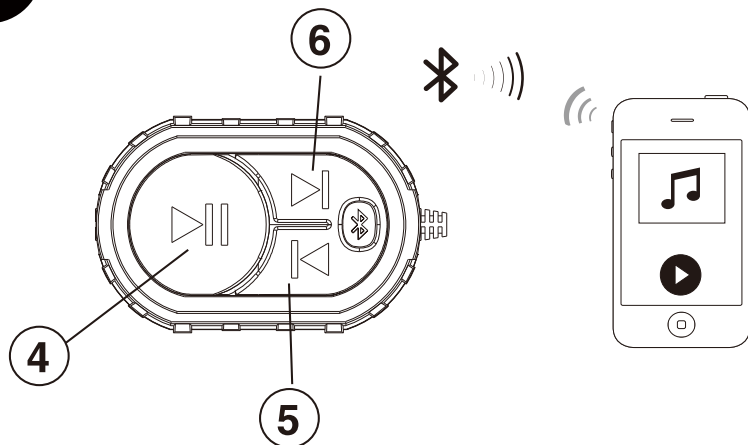

Using this product without running the engine can drain the battery.



MULTIFUNCTION CONTROLLER BLUETOOTH OPERATION

- 1) Press the  **PLAY/PAUSE** once to start playing music or press the **PLAY** button from your device touch screen
- 2) To skip songs or advance, press the  **NEXT TRACK** button
- 3) To select the previous song, press the  **PREVIOUS TRACK** button

VOLUME CONTROL

- 4) To raise the volume, **Press and Hold** the  **VOL +** button 2 ~ 3 seconds
- 5) To lower the volume, **Press and Hold** the  **VOL -** button 2 ~ 3 seconds





Tips: Make sure your device Bluetooth volume is set at 75% level before stowing in to the carry pouch

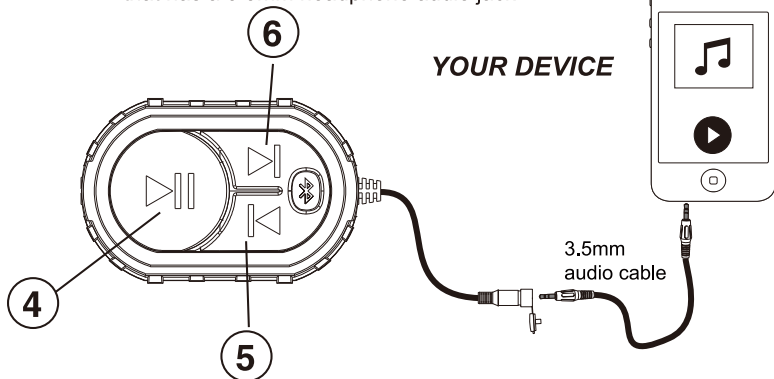

B82ABT can play audio from any device that has a 3.5mm headphone audio jack.



MULTIFUNCTION CONTROLLER AUX-IN OPERATION

- 1) Power on the **B82ABT** by pressing and holding down the  **PLAY/PAUSE** multifunction button for 3 seconds
- 2) Disconnect any paired **Bluetooth** device by turning off **Bluetooth** in your devices **Settings Menu**
- 3) Using the supplied 3.5mm audio cable, connect the 3.5mm AUX jack of the multifunction controller to the headphone jack on your device.
The  LED turns red to indicate it is in AUX mode.

VOLUME CONTROL

- 4) To raise the volume, **Press and Hold** the  **VOL +** button 2 ~ 3 seconds
 - 5) To lower the volume, **Press and Hold** the  **VOL -** button 2 ~ 3 seconds
- The buttons on the multifunction controller cannot be used to select songs.



Tips: Make sure your device headphone volume is set at 75% level before stowing in to the carry pouch

9

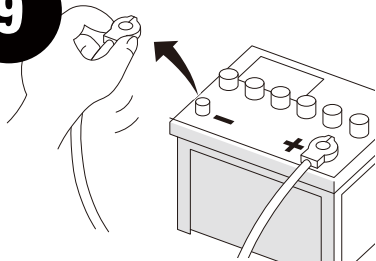
BEFORE INSTALLING THIS PRODUCT

To avoid potential shorts in the electrical system, be sure to disconnect the (-) battery cable before installation. Use this unit with a 12-Volt battery and negative grounding only. Failure to do so may result in a fire or malfunction.

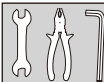
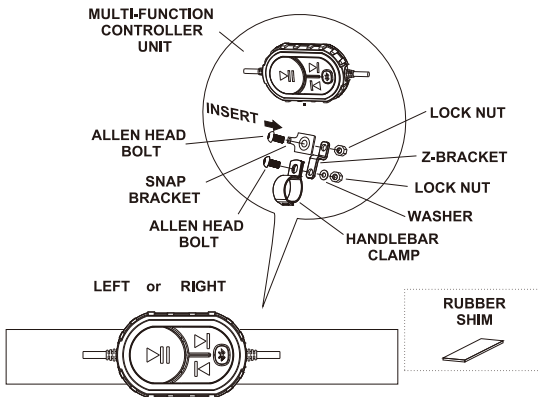

When replacing the fuse, be sure to only use a fuse of the rating specified on this product. To avoid short-circuiting, cover any disconnected leads with insulating tape. It is especially important to insulate any unused wires, which if left uncovered may cause a short circuit. When connecting other devices to this product, refer to the manual for the product to be connected. The black cable is ground, make sure to connect the ground wire first. Ensure that the ground wire is properly connected to metal parts of the vehicles body frame or direct to the battery if your vehicle does not have a grounded chassis frame. The ground wire of this unit power amp and a second powered system must be connected to the frame separately with different screws. If the screw for the ground wire loosens or falls out, it could result in fire or malfunction.

SPEAKER MOUNTING SUGGESTIONS**TOOLS NEEDED:**

- 12mm Socket, Wrench or Pliers
- 6mm Allen Wrench

Hand Tools Required:

- 3/16" Hex Key and Bit Socket
- 5/32" Hex Key and Bit Socket
- Torque Wrench (in/lbs or nM)
- Thread Lock Compound

STEP 1: Removing the top half of clamp

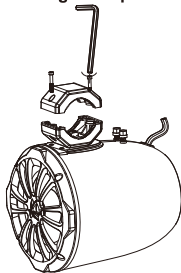

Using the 3/16" Hex key, remove the top clamp bolts, and note the Caution labels for correct torque settings later.

STEP 2: To adjust speaker position

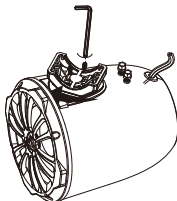

If speaker position is not to be changed, remove the screws and apply threadlocker compound. Using the 5/32" hex bit socket, torque swivel screws to 44 in/lbs (5nM).

To change the speaker position, use the 5/32" hex key remove the screws.

Note: the orientation of the screws must remain in the 12 and 6 o'clock positions after moving the bottom clamp to the desired position.

STEP 3: Swivel screws

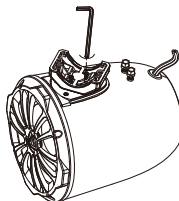

Apply thread locker compound to the screws. Tighten the screws using the 5/32" Hex bit socket and torque wrench to 44 in/lbs (5nM).

STEP 4: Securing clamp bolts

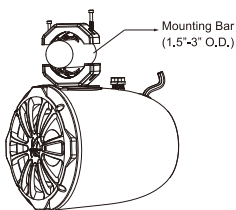

Using the correct rubber pads (labeled for O.D.) install on both top and bottom half of clamps. Apply thread locker compound to the bolts. Hand tighten the bolts evenly (both sides should have the same spacing between bolts). Using the 3/16" Hex bit socket, set the torque wrench to 65 in/lbs (7nM).

STEP 5: Security rope

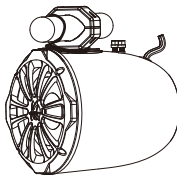

Loop the rope around the base of the clamp and bar, secure with the supplied hardware.

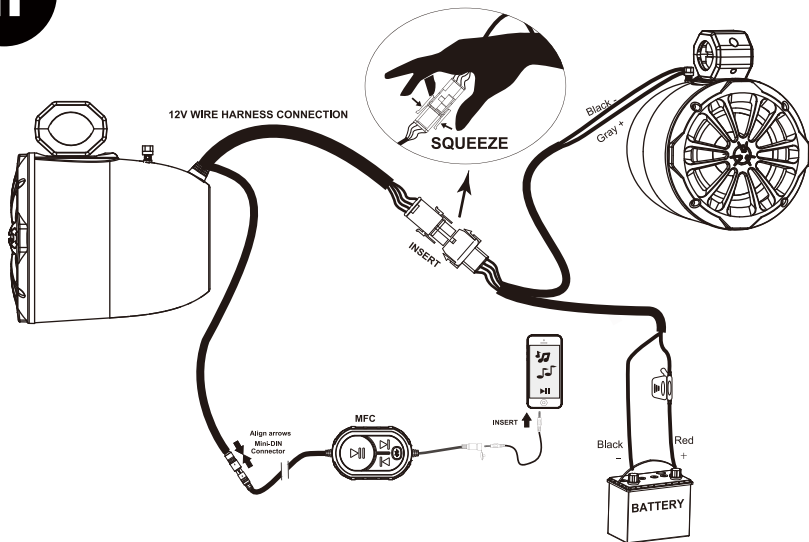

SPECIFICATIONS

BLUETOOTH

- Version: 5.0 w/ EDR
- A2DP, AVRCP
- Range: 33ft/ 10m (line of sight)

SPEAKERS

- Impedance: 4Ω
- Magnet: Ferrite
- Cone Type: Injected Polypropylene Cone with Butyl Rubber Surround
- Tweeter Size: 1" PEI DOME

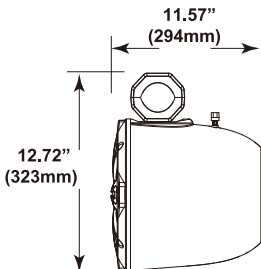
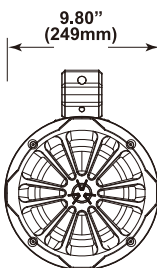
**AMPLIFIER**

- Input impedance: 10kΩ
- Frequency Response: 45Hz-20kHz
- Low Battery Shut Off
- Standby Current 0.5mA

GENERAL

- Swivel Metal Clamp System: 1-1/2" – 3"
- Operational Power: 12VDC (10-16V allowable)
- MAX Current Draw: 7.8 A
- Replacement Fuse: 10A AGC TYPE
- Color: Black
- Weight: 19.4lbs / 8.8Kg
- Dimensions cm WxHxD: 24.88 x 32.3 x 29.4
- Dimensions Inches WxHxD: 9.8 x 12.72 x 11.57



BOSS[®]
AUDIO SYSTEMS



B82ABT

POWERSPORTS

BOSS[®]

AUDIO SYSTEMS

BOSS Audio Systems
3451 Lunar Court • Oxnard, CA 93030
www.bossaudio.com
805-751-4853 Customer Service
Tech Support: www.bossaudio.com/support



1121

The Bluetooth® word mark and logos are registered trademarks owned by Bluetooth SIG, Inc. and any use of such marks by BOSS Audio Systems is under license. Other trademarks and trade names are those of their respective owners.