



**Storm MMXI Air Powered
Hockey Table**

Item 64-3011

**STORM MMXI AIR POWERED
HOCKEY TABLE**



Replacement Parts

Order direct at www.gldproducts.com
or call our Customer Service department at
(800) 225-7593
8 am to 4:30 pm Central Standard Time

GLD Products

**Storm MMXI Air Powered
Hockey Table**

Item 64-3011

Staple your receipt here.

Important: A copy of your receipt will be needed to activate your warranty (see page 14).

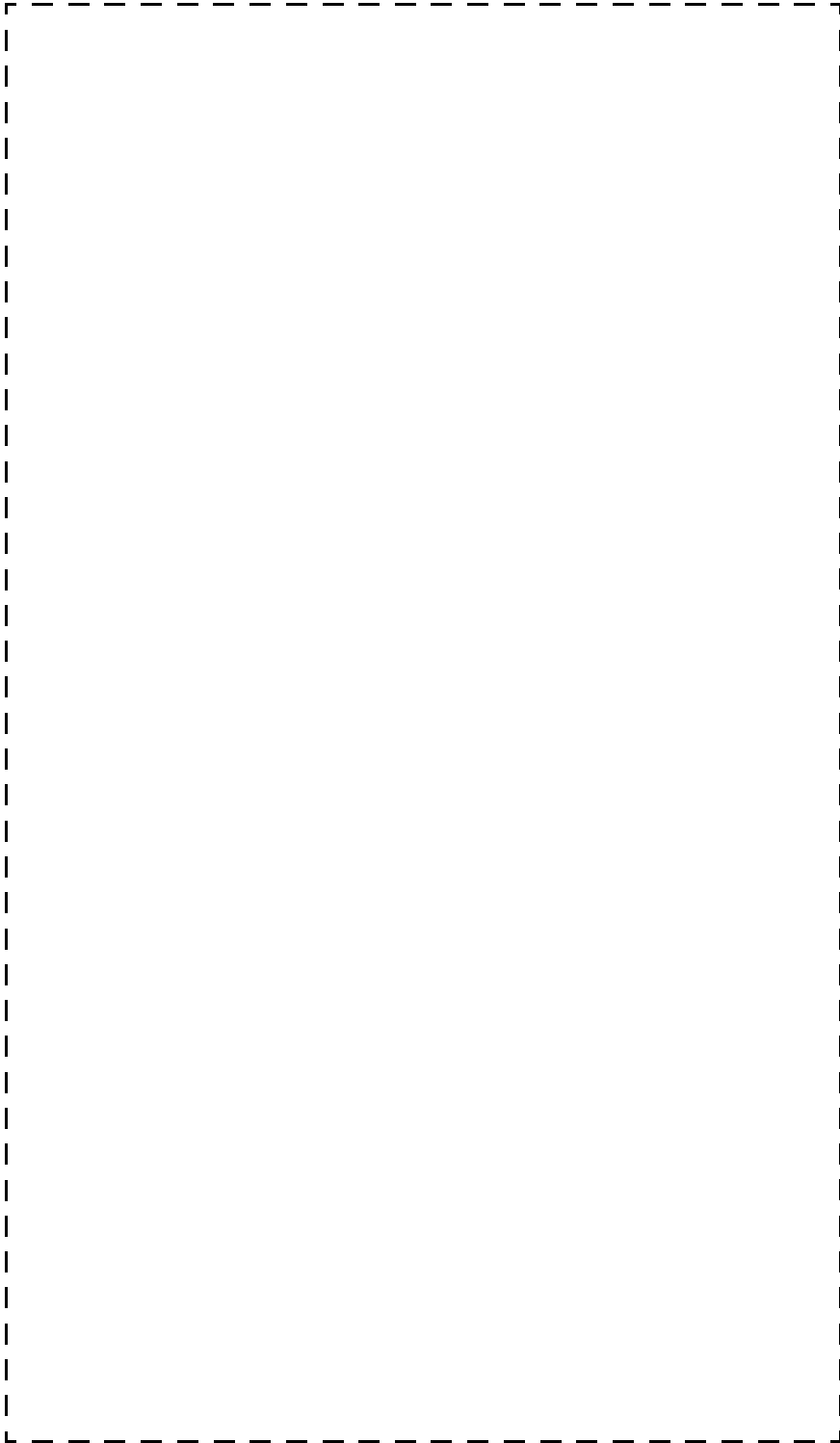

GLD Products **Storm MMXI Air Powered Hockey Table**

Item 64-3011

Congratulations and THANK YOU for purchasing the Storm MMXI Air Powered Hockey Table. You have chosen a product that should provide years of entertainment. To assist you with customer service and warranty claims, staple your receipt to the inside cover, then keep this manual in a safe place for future reference.









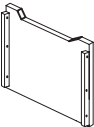
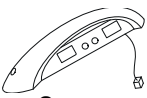

GLD Products

S84 W19093 Enterprise Drive
Muskego, WI 53150 USA
1-800-225-7593
Fax: 1-800-841-6944
Email: gld@gldmfg.com
Web: www.gldproducts.com

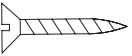
This manual may have been updated. For the latest manual visit the GLD Products website.

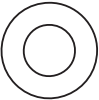
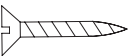
	<p>Place your package near the location where it will be used. Carefully unpack all components and verify you have all the correct pieces.</p> <p>If you notice missing or defective parts, please call us at: 1-800-225-7593.</p>
---	---

	<p>Please read and understand all instructions before beginning assembly.</p> <p>This assembly will require 2 adults.</p> <p>This product is not for use by children without adult supervision.</p>
---	--

Part No./ Qty	Illustration/ Order Number	Part No./ Qty	Illustration/ Order Number	Part No./ Qty	Illustration/ Order Number
1 Qty. 2	 Left Leg Order No. 4-202	2 Qty. 2	 Right Leg Order No. 4-203	3 Qty. 2	 Leg End Panel Order No. 4-204
4 Qty. 1	 Scorer Order No. 4-205	5 Qty. 4	 Leg Leveler Order No. 4-206	6 Qty. 2	 3.5 mm x 28 mm Screw Order No. 4-209
7 Qty. 12	 8 mm x 45 mm Bolt Order No. 4-210	8 Qty. 12	 M8 Washer 22 mm Order No. 1-211	9 Qty. 12	 3.5 mm x 33 mm Screw Order No. 4-212
10 Qty. 2	 Goalie Order No. 2-18	11 Qty. 2	 Hockey Puck Order No. 4-117	12 Qty. 1	 Allen Wrench Order No. 2-116
13 Qty. 1	 Table Top Assembly Order No. 4-207				

IF YOU HAVE A WARRANTY CLAIM, CALL US FIRST

Please see page 14.

GLD Products

Available 8 am to 4:30 pm Central Standard Time

S84 W19093 Enterprise Drive
Muskego, WI 53150 USA
1-800-225-7593
Fax: 1-800-841-6944
Email: gld@gldmfg.com
Web: www.gldproducts.com

For all claims, please have your receipt and item number when you call. The product item number can be found on the front cover.

If you are instructed to return the product for service, you are responsible for shipping the unit at your expense.

PRODUCT REGISTRATION

Important: The product registration form on page 15 and a copy of your receipt must be completed and returned within 10 days of purchase to validate your warranty.

Online registration is also available. Go to <http://gldproducts.com/warranty-information> or click on this link. Follow the online instructions.

Preparing for Assembly

- Be sure to unpack all of the parts included in this package. Check inside any tubes or sleeves. Save all packing material until the product is fully assembled and functional.
- Compare the parts in your package with the Parts Identifier description on page 5.
- After unpacking large products, some disassembly may be required prior to beginning the assembly.

Tools Required

- Wrench (#8)
- Phillips screwdriver (not included)
- Allen Wrench (#12)
- Level (not included)
- Electric screwdriver may be helpful. **CAUTION:** You must set at **LOW TORQUE** and use extreme caution because you could overtighten the hardware, strip the screws, or damage the table.

Assembly Tips

Make sure you understand the following before you begin to assemble your game table.

1. READ THIS MANUAL all the way through before beginning assembly.
2. When installing parts that have more than one bolt, start ALL bolts in that part by hand before tightening anything.
3. Some drawings or images in this manual may not look exactly like your product.
4. You will need a second adult to assist with this assembly.

Note: Save all packing materials until the parts have been inspected and the table is assembled.

Unpack the Pieces

- Lay the box on a flat surface (floor). You may want this near your area of assembly.
- Unpack the boxes and part bags. Inspect and count the parts. The Parts Identifier page can be used to record your results.
- If any parts are damaged or missing, contact GLD Customer Service.
- Missing fasteners may be purchased at a hardware store using the descriptions on the Parts Identifier page.

Games

This game table includes the equipment and game pieces for Air Powered Hockey. The rules for this game are not discussed in this manual.

STEP 1 - ASSEMBLE THE LEGS

Each leg has three main pieces. The two legs (#1 and #2) are not the same.

1. Position a leg (#1 or #2) to fit against the support brace. Use three washers (#8) and three bolts (#7) to hold the two pieces together.
2. Attach the other legs in the same manner.
3. Screw a leg leveler (#5) into the holes on the bottom of each leg. The levelers should be screwed in half way.

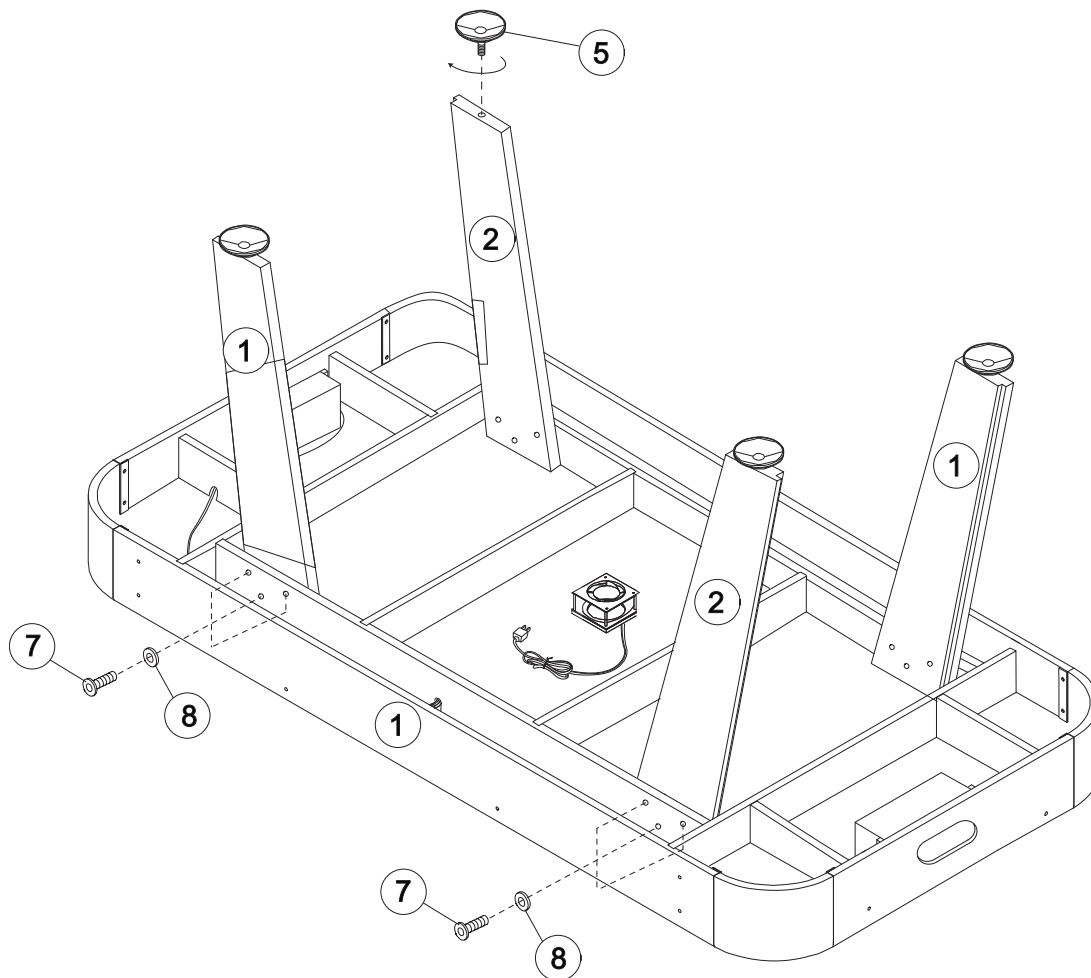

STEP 2 - ATTACH THE LEGS

1. Position a leg end panel (#3) so the bottom end has the straight edge and the screw holes are lined up.
2. Insert a screw (#9) into the six holes on each leg end panel. Finger start the screws into the pre-drilled holes in the legs.
3. Repeat for the remaining legs.

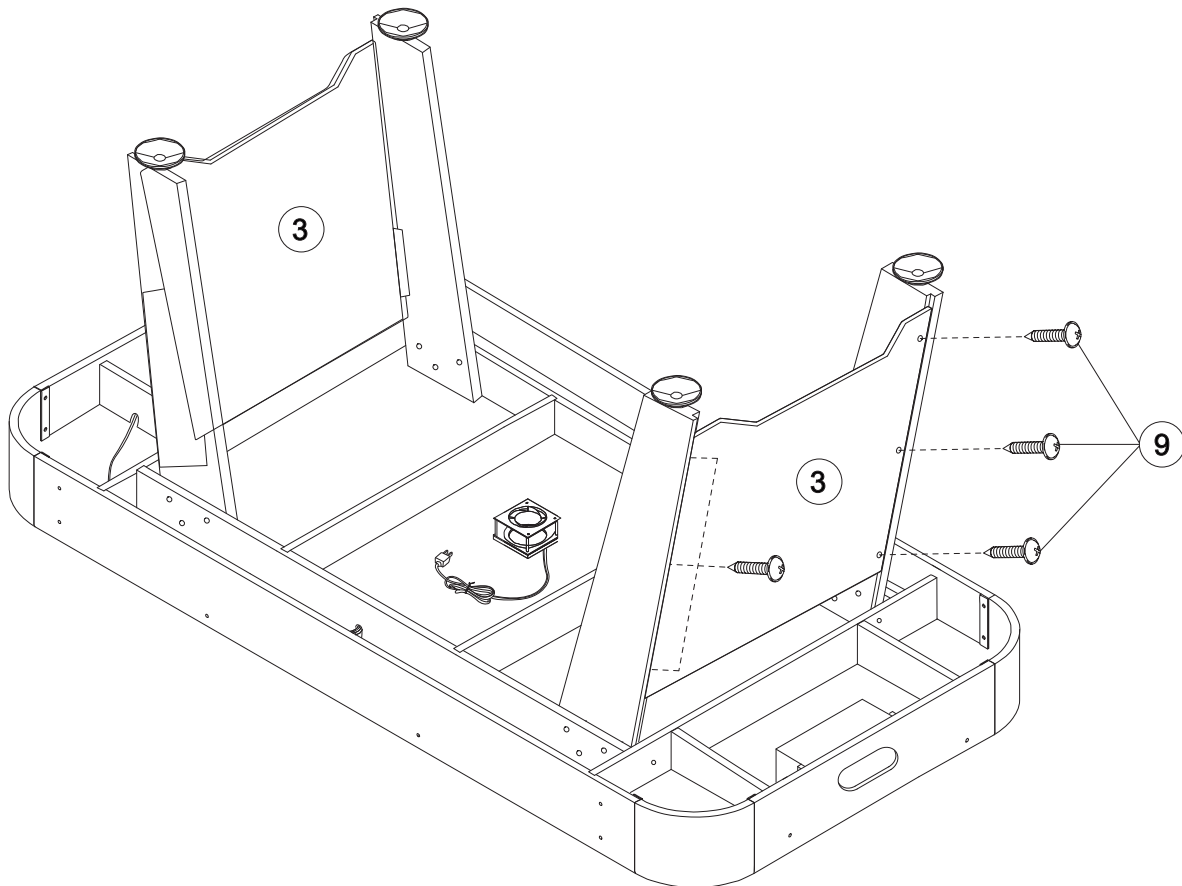

GLD Products Storm MMXI Air Powered Hockey Table

Item 64-3011

STEP 3 - TURN THE TABLE OVER

The table is ready to be turned over.

USE AT LEAST TWO PEOPLE TO LIFT THE TABLE ASSEMBLY AND TURN IT OVER TO REST ON THE LEGS.

DO NOT ROLL THE TABLE OVER. This will place a sideways force on the legs. The legs should be off the floor until the table assembly is rotated completely. Set the table down.

DO THIS

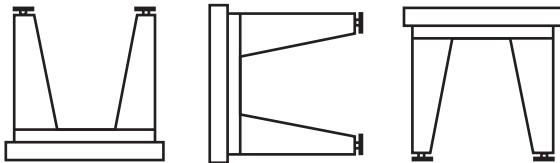

NOT THIS

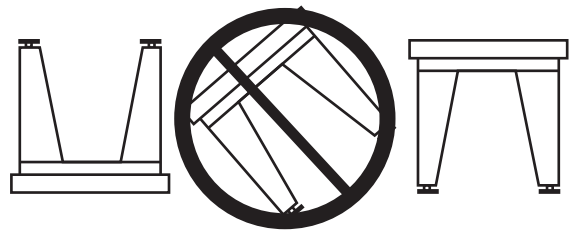

STEP 4 - MOUNT THE SCOREBOARD

1. Position the electronic scorer (#4) over the holes in the table side rail.
2. Route the wires from the goals through into the holes. Plug the connectors into the bottom of the electronic scorer (#4). Set the scoreboard down on the table side rail.
3. Hold the electronic scorer (#4) in position and insert two screws (#6) into the table to hold the scorer. Tighten the screws.
4. Under the table top, check the wiring connections.

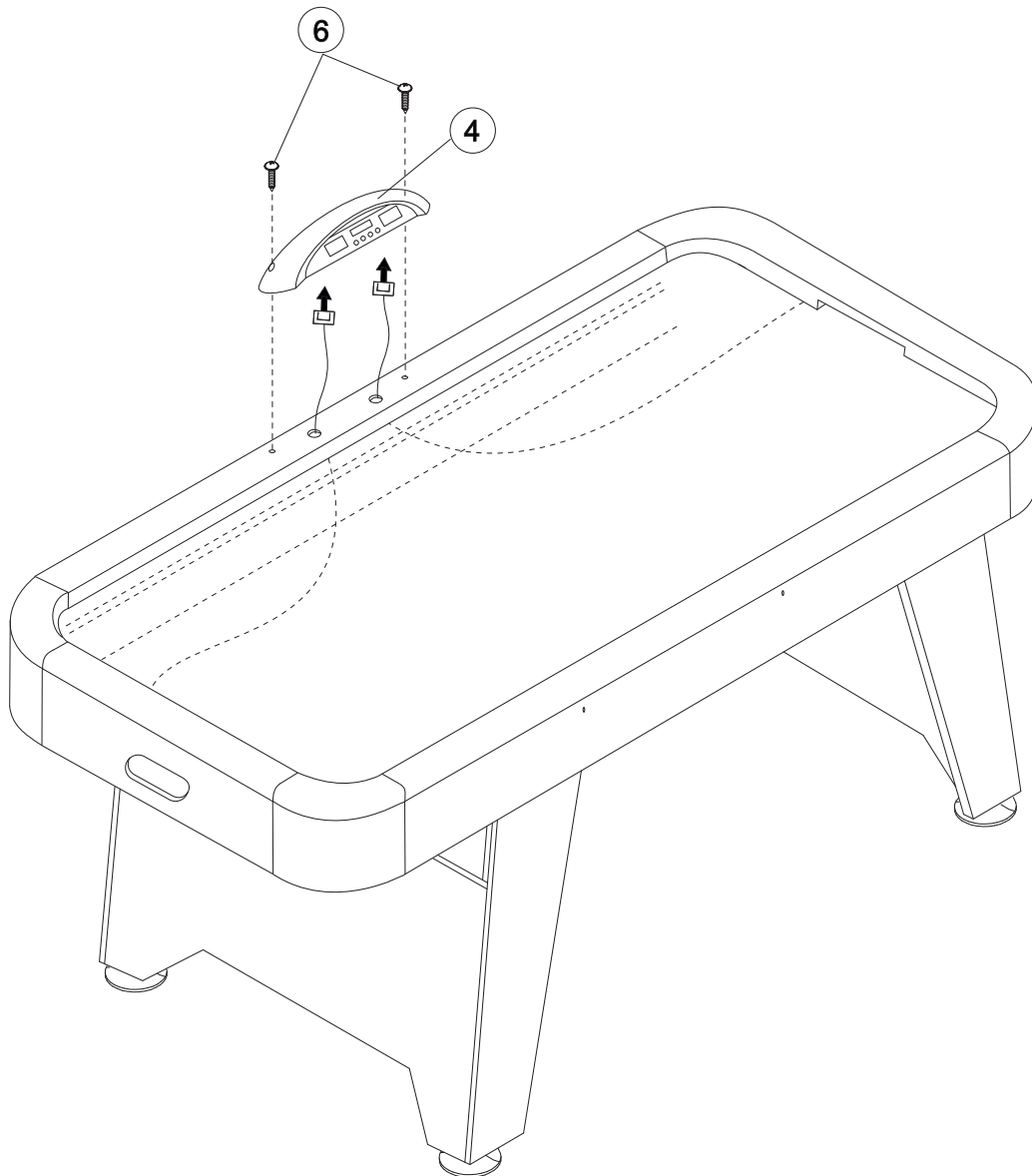

STEP 5 - OPERATION

1. Plug the fan electrical cord into a standard wall plug.
2. On the electronic scorer (#4), remove the battery cover. Insert three AAA batteries (not included). Follow the polarity shown on the inside cover. To turn the electronic scorer on, press the On/Off button once. Wait for the opening fanfare and the countdown to finish. To turn the scoreboard off, press and hold the On/Off Button for three seconds.
3. Press the start button to begin a game. Scoring is registered automatically. To start a new game, press and hold the start button for three seconds.
4. To turn the sound off, press the On/Off button once. Press again to turn the sound back on.

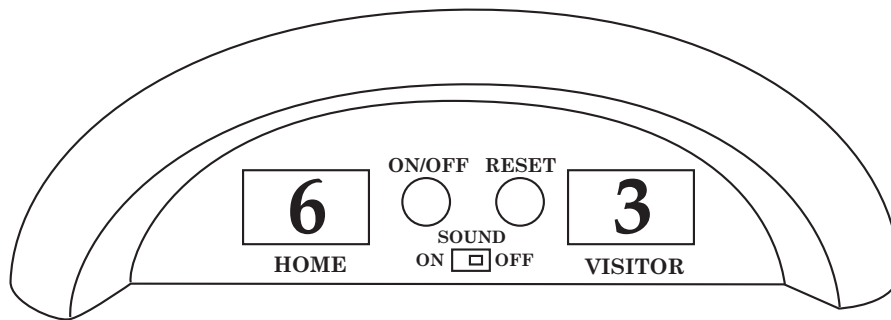
**STEP 6 - LEVEL THE TABLE**

1. Place the table in position.
2. Use a carpenter's level to find the low side of the table.
3. Raise or lower the leg levelers as needed to level the table.
4. Level the table side-to-side and end-to-end. When the game is turned on, the puck will float to a low side. Final leveling can be performed if needed.

Care and Use of your Table

- This product is intended for INDOOR use only.
- DO NOT sit, climb, or lean on the table.
- DO NOT drag the table when moving it. This will damage the legs.
- Keep your table covered.
- To clean the hard surfaces spray a cloth with a mild cleaner and wipe.
- Pucks that fly off the table may have chipped edges. Inspect the puck and replace if needed.
- The air holes may become plugged, causing the puck to drag. A small drill bit can be used to re-open the holes. DO NOT use a power drill. Instead, hold the drill bit in your fingers and clear the holes.

GLD Products Storm MMXI Air Powered Hockey Table

Item 64-3011

90-DAY LIMITED WARRANTY

The Manufacturer warrants to the original retail purchaser that this product is free from defects in material and workmanship under normal use and conditions for a period of ninety (90) days from the date of original purchase. The Manufacturer's liability is limited to the repair or replacement, at its option, of any defective product and shall not include any liability for indirect, incidental or consequential damages of any kind. Should this product become defective due to material or workmanship within the warranty period, contact our Customer Service Department. This warranty is not transferable and does not cover normal wear and tear or damage caused by improper usage, negligence, misuse, abuse, transportation damage, acts of nature, or accident (including failure to follow the instructions in this manual). It does not cover expendable items such as batteries, light bulbs, fuses, accessories, cosmetic parts and other items that wear out due to normal usage, including felt covered areas of the playing surface. This warranty is also void if the product is disassembled and reassembled, damaged, modified from its original state, or used for other than indoor personal residential use (no commercial or rental applications).

This warranty gives you specific legal rights, and you may have other rights which vary from state to state.

IF YOU HAVE A WARRANTY CLAIM, CALL US FIRST (8 - 4:30 CST)

Please have your receipt and item number (found on the front cover) when you call.

GLD Products

S84 W19093 Enterprise Drive
Muskego, WI 53150 USA
1-800-225-7593
Fax: 1-800-841-6944
Email: gld@gldmfg.com
Web: www.gldproducts.com

If you are instructed to return the product for service, you are responsible for shipping the unit at your expense to the above address in packaging that will protect against further damage. All warranty or repair requests require a Return Authorization Number prior to returning the item.

PRODUCT REGISTRATION

Important: The product registration form on page 15 must be completed and returned along with a copy of your receipt within 10 days of purchase to validate your warranty.

Online registration is also available. Go to <http://gldproducts.com/warranty-information> or click on this link. Follow the online instructions.

REGISTER YOUR PRODUCT

Place postage here

Complete this form, include a copy of your receipt, fold, tape (do not staple) and return within 10 days of purchase. This protects your warranty and will help us develop new products!

Cut here.

GLD Products
Warranty Department
S84 W19093 Enterprise Drive
Muskego, WI 53150 USA

Fold here second.



P R O D U C T S

www.gldproducts.com

GAME TABLES	HOME CASINO
GAMES AND ACCESSORIES	BILLIARD CUES
BILLIARD ACCESSORIES	DARTBOARDS
SOFT-TIP DARTS	STEEL-TIP DARTS
FLIGHTS AND SHAFTS	DART CASES AND ACCESSORIES

Fold here first.

Name	Date of Purchase
Address	Phone-Day
City	Phone-Evening
State Zip	Email
Purchase Price:	Item: 64-3011 Storm MMXI Air Powered Hockey Table
Store Name:	

Remember to attach a copy of your receipt.

This page is left blank intentionally.

Mail To: GLD Products
S84 W19093 Enterprise Drive
Muskego, WI 53150 USA
1-800-225-7593 • FAX 800-841-6944
Email: gld@gldmfg.com
Web Site: www.gldproducts.com

***Storm MMXI Air Powered
Hockey Table***
Item 64-3011
Parts Re-Order Form

Please call or consult the GLD website gldproducts.com to order the following parts.

Order No.	Description
4-202	Left Leg
4-203	Right Leg
4-204	Leg End Panel
4-205	Scorer
4-206	Leg Leveler
4-209	3.5 mm x 28 mm Screw
210	8 mm x 45 mm Bolt
4-211	M8 Washer 22 mm
4-212	3.5 mm x 33 mm Screw
2-18	Goalie
2-19	Hockey Felt
4-117	Hockey Puck
1-17	Wrench
2-116	Allen Wrench
4-207	Table Top Assembly
4-208	Fan - preassembled

This page is left blank intentionally.

GLD[®]

P R O D U C T S

www.gldproducts.com

GAME TABLES

HOME CASINO

GAMES AND ACCESSORIES

BILLIARD CUES

BILLIARD ACCESSORIES

DARTBOARDS

SOFT-TIP DARTS

STEEL-TIP DARTS

FLIGHTS AND SHAFTS

DART CASES AND ACCESSORIES



PROUD MANUFACTURER OF



S84 W19093 Enterprise Drive • Muskego, WI 53150 USA
262.679.8730 or 1.800.225.7593 tele
262.679.8738 or 1.800.841.6944 fax
Email: gld@gldmfg.com
www.gldproducts.com