



BVCP9850W

USER MANUAL

WIRELESS Apple CarPlay & Android Auto™

BLUETOOTH® | 320 WATTS | DOUBLE-DIN

FEATURING 6.75" (171 mm) CAPACITIVE TOUCHSCREEN





Thank you for Choosing BOSS Audio Systems!

IMPORTANT! Fill Out And Keep For Your Records.



IMPORTANT

Record the serial number of the product:

Model:

Serial Number:

Date of Purchase:

The serial number is located on the top part of the chassis.

Contents

| | | | | | |
|---------------------------------------|-------|--------------------------|-------|-----------------------------|----|
| Contents..... | 2-3 | Android Auto..... | 17 | Radio..... | 23 |
| Notes..... | 4 | Warnings..... | 17 | Tuning..... | 23 |
| FCC Statement..... | 5 | Using Android Auto..... | 17-18 | Bands..... | 23 |
| Cautions..... | 6-8 | Bluetooth® | 19 | RDS/RBDS..... | 23 |
| About This Manual..... | 8 | Setup & Connections..... | 19 | Aux-In | 24 |
| California Prop. 65..... | 8 | Phone book..... | 19 | Playback..... | 24 |
| Basic Product Operation | 9 -14 | Device Status..... | 19 | Camera | 24 |
| Product Basics..... | 10-15 | Calling..... | 20 | Warnings..... | 24 |
| Using/Caring for the Touchscreen..... | 12 | History..... | 20 | Reverse View..... | 24 |
| Product Setup..... | 13 | Private Mode..... | 20 | Audio Settings | 25 |
| Navigating the Menus..... | 14 | Call Waiting..... | 20 | System Tone..... | 25 |
| Apple CarPlay | 15 | Audio..... | 21 | Loudness..... | 25 |
| Warnings..... | 15 | Track Control..... | 21 | Subwoofer..... | 25 |
| Using CarPlay..... | 15 | Media | 22 | Volume..... | 25 |
| Gestures & Control..... | 15 | Warnings..... | 22 | Source Level..... | 25 |
| Apple CarPlay Display..... | 16 | USB Playback..... | 22 | Audio Effect..... | 25 |
| Disable Apps..... | 16 | Navigating Menu..... | 22 | Balance Fader..... | 25 |
| | | Photos..... | 22 | | |

Contents

| | | | | | |
|---------------------------------|-----------|--------------------------------------|-----------|-----------------------------------|-------|
| General Settings..... | 26 | Bluetooth Setting..... | 27 | SWC Compatibility..... | 35 |
| Date & Time..... | 26 | Bluetooth Power..... | 27 | SWC Introduction..... | 35 |
| Android Auto..... | 26 | Auto Connect..... | 27 | Programmable Controls..... | 35 |
| Camera Settings..... | 26 | Auto Answer..... | 27 | SWC Installation/Programming..... | 35 |
| ACC OFF..... | 26 | Auto Download Phone Book..... | 28 | Troubleshooting..... | 36-37 |
| System Language..... | 26 | Radio Settings..... | 28 | Specifications..... | 38 |
| Power Off Delay..... | 26 | Seek Quality..... | 28 | | |
| Advance Settings..... | 26 | Region..... | 28 | | |
| Display Settings..... | 27 | RDS/RBDS..... | 28 | | |
| Day Brightness..... | 27 | Alternative Frequency (AF)..... | 28 | | |
| Night Brightness..... | 27 | Traffic Announcement (TA)..... | 28 | | |
| Gamma..... | 27 | About Settings..... | 29 | | |
| LED Animation..... | 27 | Connections..... | 30 | | |
| LED Color..... | 27 | Power and SWC Wiring..... | 30 | | |
| Illumination Default..... | 27 | Speaker Wiring..... | 31 | | |
| Bluetooth® Settings..... | 27 | Parking Brake and Remote Wiring..... | 32 | | |
| Bluetooth Device..... | 27 | Camera/USB/Audio/Radio/Mic..... | 33 | | |
| Apple CarPlay Device..... | 27 | Hands-free Mic Installation..... | 34 | | |

Important

This symbol with “WARNING” is intended to alert the user to the presence of critical instructions/procedures. Failure to observe the instructions/procedures can result in injury, death, damage to the product and or property.



This symbol with “CAUTION” is intended to alert the user to the presence of important instructions/procedures. Failure to observe the instructions/procedures can result in injury or damage to the product and or property.



Use of the Apple CarPlay logo means that this user interface meets Apple performance standards. Apple is not responsible for the operation of this device or its compliance with safety and regulatory standards. Please note that the use of this product with iPhone, iPod or iPad may affect wireless performance.

iPod® and iPhone® is a trademark of Apple Inc., registered in the U.S. and other countries.

Apple CarPlay is a trademark of Apple Inc.

Android Auto is a trademark of Google LLC.

The *Bluetooth*® word mark and logos are registered trademarks owned by Bluetooth SIG, Inc. and any use of such marks by BOSS Audio Systems is under license. Other trademarks and trade names are those of their respective owners.

Caution

FCC Compliance Statement

This device complies with part 15 of the FCC Rules. Operation is subject to the following two conditions: (1) this device may not cause interference, and (2) this device must accept any interference, including interference that may cause undesired operation of this device. This transmitter must not be co-located or operated in conjunction with any other antenna or transmitter. The Bluetooth antenna cannot be removed (or replaced) by user. This equipment complies with FCC/ IC radiation exposure limits set forth for an uncontrolled environment and meets the FCC radio frequency (RF) Exposure Guidelines and RSS-102 of the IC radio frequency (RF) Exposure rules. This equipment has very low levels of RF energy that it deemed to comply without maximum permissive exposure evaluation (MPE). But it is desirable that it should be installed and operated keeping the radiator at least 20 cm or more away from person's body (excluding extremities: hands, wrists, feet and ankles). Alteration or modifications carried out without appropriate authorization may invalidate the user's right to operate the equipment.

NOTE: This equipment has been tested and found to comply with the limits for a Class B digital device, pursuant to Part 15 of the FCC Rules. These limits are designed to provide reasonable protection against harmful interference in a residential installation. This equipment generates, uses and can radiate radio frequency energy and, if not installed and used in accordance with the instructions, may cause harmful interference to radio communications. However, there is no guarantee that interference will not occur in a particular installation. If this equipment does cause harmful interference to radio or television reception, which can be determined by turning the equipment off and on, the user is encouraged to try to correct the interference by one or more of the following measures: Relocate or reorient the receiving antenna. Increase the separation between the equipment and receiver. Connect the equipment into an outlet on a circuit different from that to which the receiver is connected. Consult the dealer or an experienced radio/TV technician for help.



Caution

Adjustments or alterations of this device may result in hazardous radiation exposure.

Caution

Precautions

BE SURE TO OBSERVE THE FOLLOWING GUIDELINES: Do not turn up the volume so high that you can't hear what's around you.

Use caution or temporarily discontinue use in potentially hazardous situations.

Do not operate mobile video equipment while driving a motorized vehicle – safe driving and safety consideration of others should always be your highest priority.

Set your volume control at a low setting, then slowly increase the sound until you can hear it comfortably without distortion, or ear discomfort.

In the event you should notice smoke, strange noises or odor from this product, or any other abnormal signs, immediately turn off the power and consult your dealer or the nearest authorized **BOSS AUDIO SYSTEMS** Service Center.

Using this product in this condition may result in permanent damage to the system.

Installation Precautions

BOSS AUDIO SYSTEMS does not recommend to install the product yourself.

We recommend to have it professionally installed by a certified professional.

Always consult with a professional installer .

Do not attempt to install or service this product by yourself. Installation or servicing of this product by persons without professional training and experience in electronic equipment and motorized vehicle accessories may be dangerous and could expose you to the risk of electric shock, injury or other hazards

Refer any repairs to a qualified BOSS AUDIO SYSTEMS Service Center.

Caution

Before Installing

To avoid potential shorts in the electrical system, be sure to disconnect the (-) battery cable before installation.

Use this unit with a 12-volt battery and negative grounding only. Failure to do so may result in a fire or malfunction.

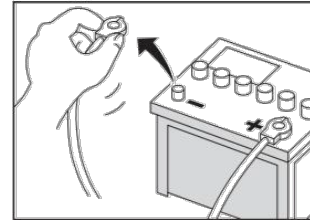
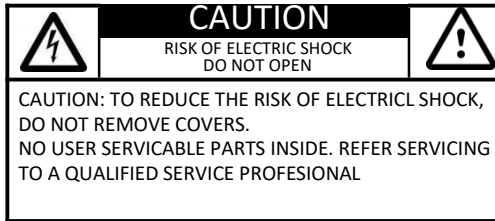

Product Safety

It is against Federal and Local laws for video to be viewed by the driver while the vehicle is in motion. This video product was intended to be used with the parking brake safety feature. Video cannot be seen without the proper parking brake powered connection. Tampering or disabling this feature will void any and all warranty. Please check with a professional installer to have your product installed properly.



Important Note

Due to ongoing enhancements, example images on screens may slightly differ from actual product.

Caution

Images and Video

Watching video while driving is against Federal, State, and Local laws.

Drive safely, know and obey traffic rules. Watching this screen and making selections while driving can lead to a serious accident.

Check surroundings for safety while camera images are displayed.

Do not use features of this product while driving if it cannot be operated safely and legally in your location. Before operation of smartphone Apps accessible from this device, read safety instructions in your Owner's Manual. When using navigation Apps stay alert to observe real world conditions.

About this manual

To entirely understand how to properly use your new BOSS product, it is recommended to read this entire user manual, and keep it in a safe place for future reference.

- Read the entire manual
- Keep the manual
- Follow all instructions
- Clean with a dry cloth only
- Do not use or operate near water
- Do not defeat any safety features

California Residents (Proposition 65)

This product may contain chemicals known to the State of California to cause cancer, birth defects or other reproductive harm.

Basic Product Operation

Front Detail



① Microphone

② Power/Home

③ Voice Control

④ Volume Control

⑤ Mute/Screen Off

Basic Product Operation

Rear Detail

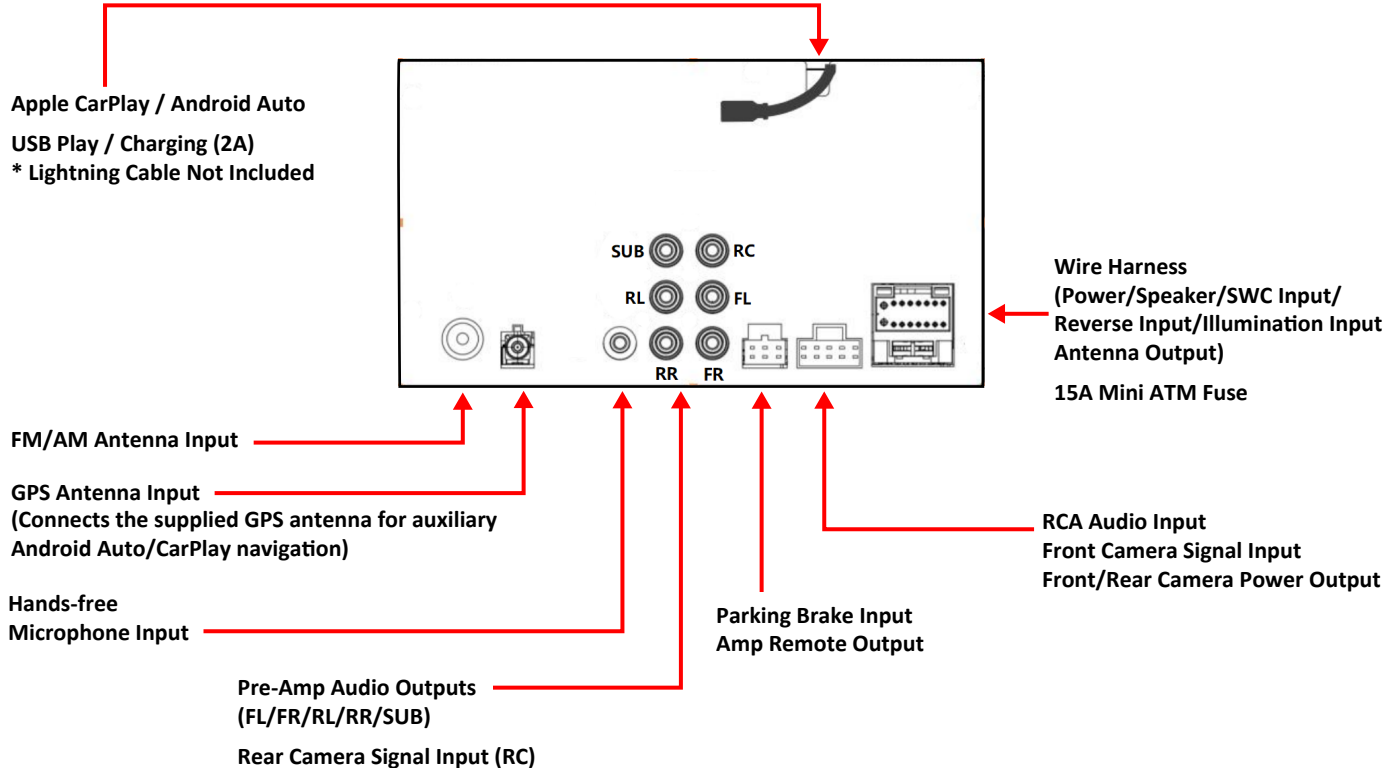

Basic Product Operation

Product Basics

Power On / Standby

1. Touch briefly to switch the unit on.
2. Touch and hold to switch the unit to standby.
In standby, the display is off.



Adjust Volume

1. Touch briefly "+" or "-".
2. Touch and hold for quick volume adjustment.

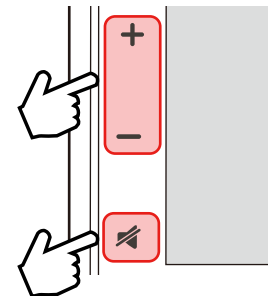

Mute

1. Touch the Mute button.

Voice Control

1. Touch to activate and then say your command.

NOTE

Apple CarPlay or Android Auto must be active to enable voice control.

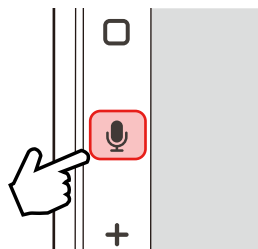

Display Off

1. Touch and hold the Mute button.

Display On

1. Touch the display to reactivate.

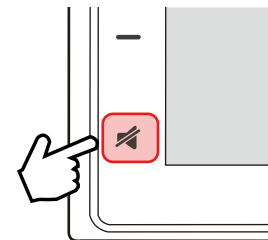

Basic Product Operation

Using and Caring for the Touch Screen

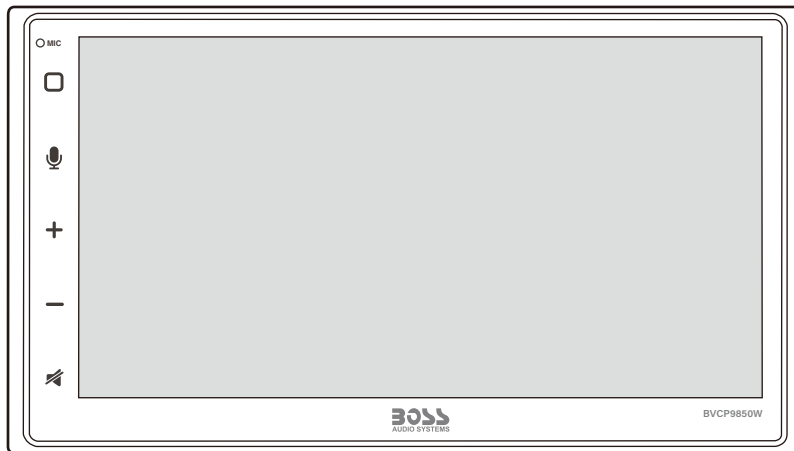

Use:

This head unit utilizes a Capacitive Touchscreen, the same type that is used on high-end mobile devices. It should be used for and cared for like that type of device. As with all capacitive type technology, if your fingers are wet or sweaty, it will not function properly.

Do not allow any sharp objects to come in contact with the screen glass.

Care and Cleaning:

To clean the screen, use a dry microfiber type cloth to clean. Do not use ammonia, window cleaner, or any other type of household chemicals to clean the screen. Abrasives should not be used at all.

Basic Product Operation

Product Setup (Date and Time)

Setup Option A: Apple CarPlay Method

Connect your iPhone to this unit through CarPlay in a wired or wireless way. See *pg.15*.

After CarPlay connection, date and time will automatically set.

User must set Time Zone manually.

Default is Pacific Time Zone

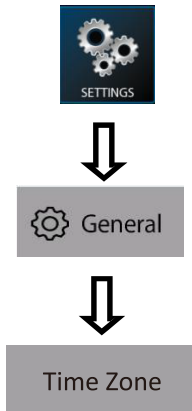

Setup Option B: Date and Time

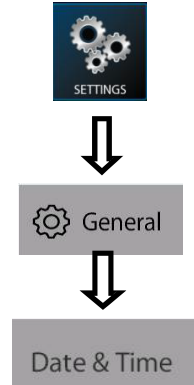

Additional Setup see *pg. 27*.

General > Language

Audio > EQ, Other Audio Settings

Display > Illumination, Brightness, LED

Basic Product Operation

Navigating the Menus

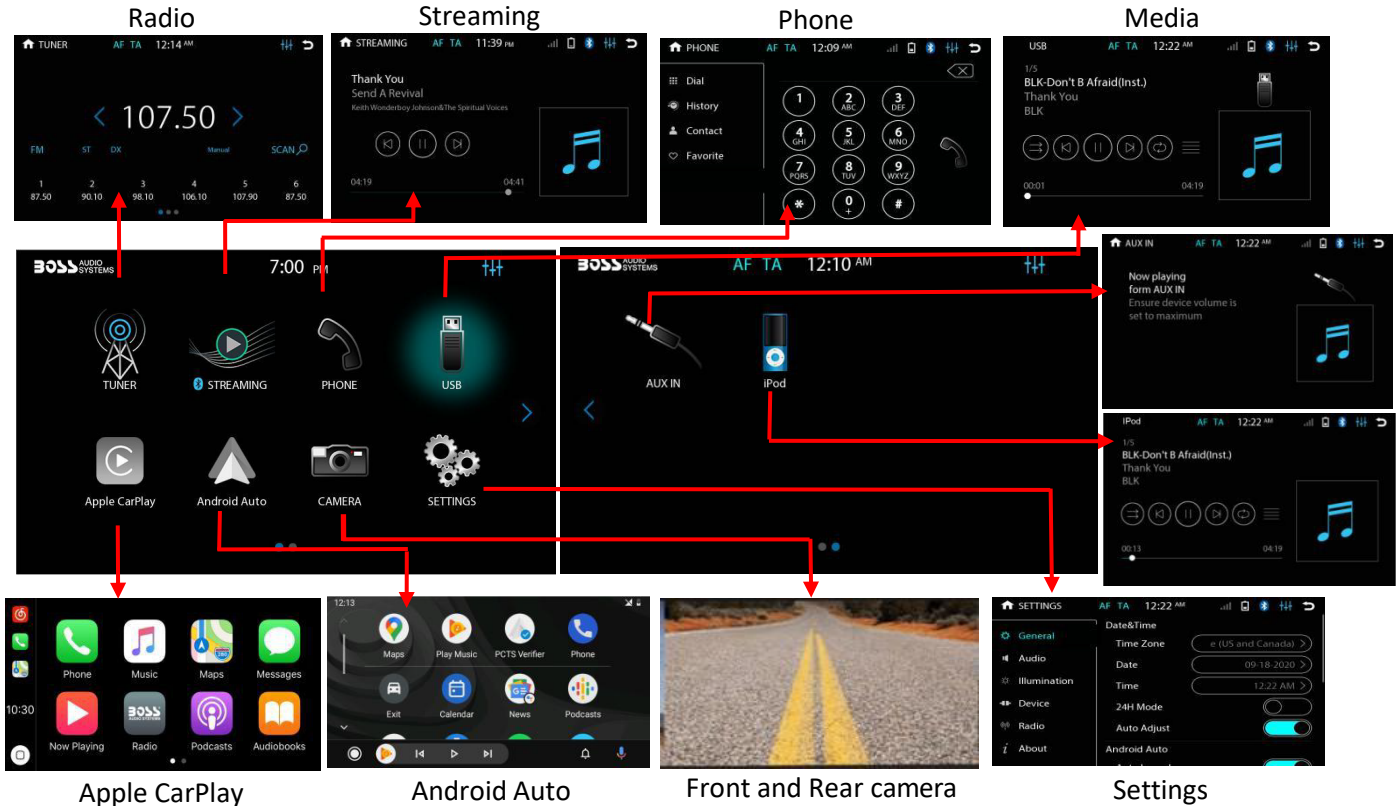

Apple CarPlay

Android Auto

Front and Rear camera

Settings

Wired and Wireless Apple CarPlay

Using CarPlay

NOTE

Apple CarPlay usage is limited while driving. Functions, content, and usability is determined by the App provider(s).

Controls will vary with each App that is available for CarPlay.

For more details visit:

<http://www.apple.com/ios/carplay>

WARNING

Familiarize yourself with your Local and State laws regarding mobile devices.

Certain functions of an iPhone might be prohibited and or illegal while driving in your location.

When in doubt, park the vehicle and engage the parking brake first before performing the function(s).

For other cautions and warnings see [pg. 6](#)

Wired Connection via USB Port

Connect your iPhone to the USB port (labeled “**Apple CarPlay**”) with a lightning cable (not included) to enable CarPlay connection.

For the initial USB connection, you will be prompted to enable wireless CarPlay on your iPhone.

Wireless Connection

Enable Wi-Fi and Bluetooth on your iPhone.

For first-time use of wireless CarPlay between your iPhone and this unit, you need to allow wireless CarPlay use via either of the pairing:

- Bluetooth pairing. On your iPhone, go to **Settings > Bluetooth** then select “**Boss Audio BVCP9850W**” for pairing. Enable wireless CarPlay when prompted on your iPhone.
- Initial USB port connection for CarPlay.

To enable CarPlay connection

Bluetooth streaming/phone will disable wireless CarPlay connection.

On the home screen, go to **SETTINGS > Device > Bluetooth Device** then touch the iPhone name to enable wireless CarPlay connection.

To enter CarPlay menu

Touch the “Apple CarPlay” icon on the home screen.

Note

If you do not allow wireless CarPlay use during first-time CarPlay connection, wireless CarPlay will be disabled on your iPhone. To use wireless CarPlay later, you need to enable CarPlay on your iPhone (go to **Settings > General > CarPlay > paired device** then enable its CarPlay).

When connecting to CarPlay, Bluetooth streaming/phone on this unit will be automatically disabled. In this case, you can make hands-free calls and stream music through CarPlay.

Gestures & Control

Basic controls, but not limited to:

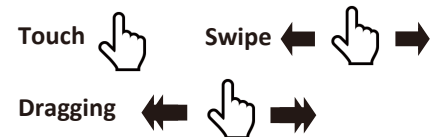

Other gestures and controls might differ from apps.

Note

Volume control is handled exclusively by this unit.

Wired and Wireless Apple CarPlay

Using CarPlay

CarPlay Display Setup

You can add, remove, or arrange the order of the apps on the CarPlay screen of the unit.

1. On your iPhone, go to **Settings > General > CarPlay**, select this head unit then select **Customize**.

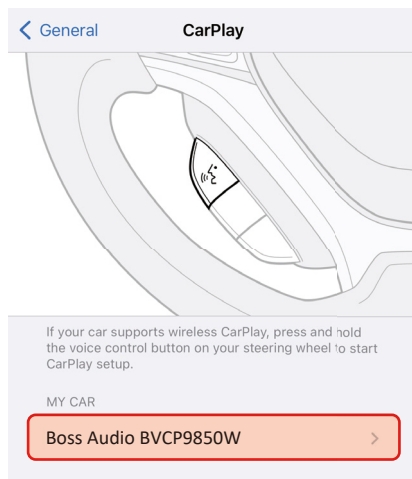

2. Touch and drag an app to change the order the apps appear on the CarPlay screen.

Touch **−** or **+** to remove and add apps.

Note

Only apps with **−** or **+** can be removed from CarPlay or added in CarPlay.

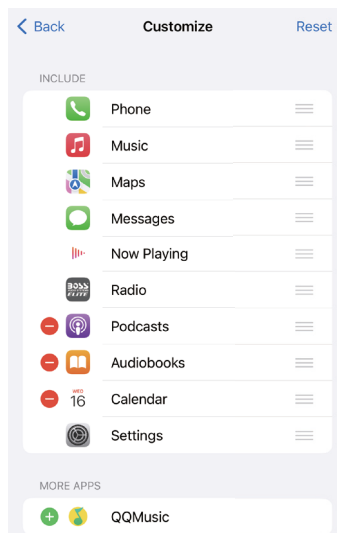

Disable Apps

You can disable all CarPlay apps to restrict CarPlay use on this unit.

On your iPhone, go to **Settings > Screen Time > Contents & Privacy Restrictions > Allowed Apps > CarPlay**.

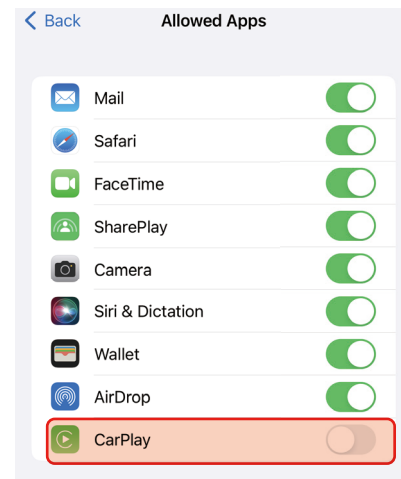

Wired and Wireless Android Auto

Using Android Auto

NOTE

Android Auto usage is limited while driving. Functions, content, and usability is determined by the App provider(s). Controls will vary with each App that is available for Android Auto.

For more details visit:

<https://www.android.com/auto/>

WARNING

Familiarize yourself with your Local and State laws regarding mobile devices.

Certain functions of the mobile device might be prohibited and or illegal while driving in your location.

When in doubt, park the vehicle and engage the parking brake first before performing the function(s).

For other cautions and warnings see *pg. 6*

NOTE

To complete the setup properly, the Parking Brake status wire must be connected. See *pg.32*

WARNING

For your safety, the setup process must be accomplished while the vehicle is parked and parking brake engaged.

Android Auto App

For Android 9.0 or earlier, download and install the Android Auto app from Google Play. For smartphone with Android 10.0 or later, plug in your phone and follow the prompts on your phone to accept the permissions that Android Auto requires.



Minimum System Requirements

- Wired connection: Android 6.0
- Wireless connection: Android 11.0

For a list of compatible devices:

<https://www.android.com/auto/>

Updating Related Apps

During the first start up and setup of the Android Auto app, the Maps, Music, Google apps will install/update automatically.

Wired Connection via USB Port

Connect your phone to the USB port (labeled “Android Auto”) with a USB cable (not included) to enable Android Auto connection.

For the initial USB connection, you will be prompted to connect wireless Android Auto on this unit.

Wireless Connection

Enable Wi-Fi and Bluetooth on your Phone.

For first-time use of wireless Android Auto between your phone and this unit, you need to allow Android Auto use via either of the pairing:

- Bluetooth pairing. On your phone, go to **Settings > Bluetooth** then select “**Boss Audio BVCP9850W**” for pairing.
- Initial USB port connection for Android Auto.

To enable Android Auto connection

Bluetooth streaming/phone will disable wireless Android Auto connection.

On the home screen, go to **SETTINGS > Device > Bluetooth Device** then touch the phone name to enable wireless Android Auto connection.

To enter Android Auto menu

Touch the “**Android Auto**” icon on the home screen.

When connecting to Android Auto, Bluetooth streaming/phone on this unit will be automatically disabled.

Wired and Wireless Android Auto

Using Android Auto

Android Auto Permissions

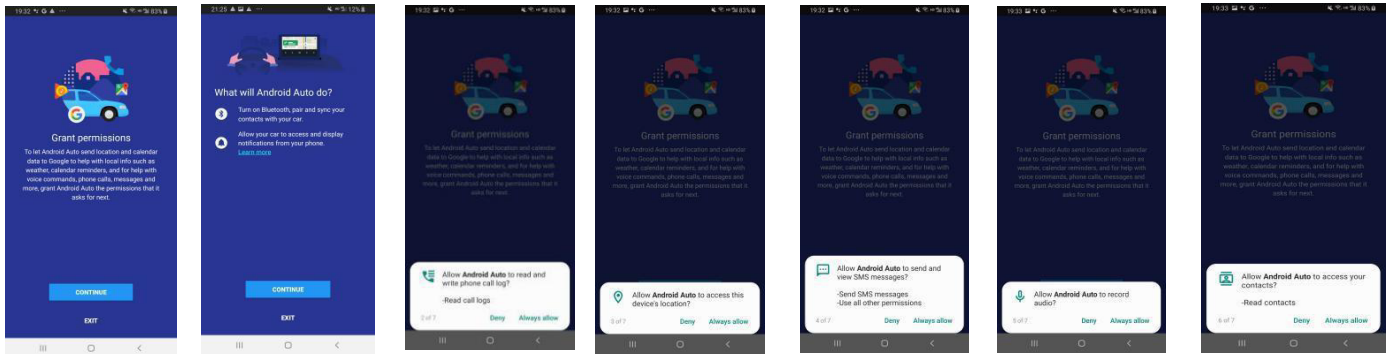

Permissions

Several features can be allowed or denied access to customize your usability of the product.

The access can always be modified in Settings on the Android device.

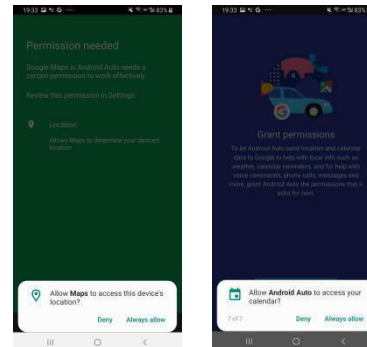

Bluetooth®

Setup and Connection

Phone Menu

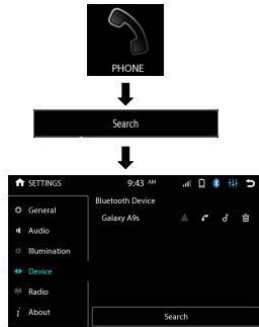

NOTE

Enabling CarPlay or Android Auto will disable Bluetooth streaming/phone.

Compatibility with all mobile devices is not guaranteed. Please read through the user guide of the mobile device.

CAUTION

For your safety, the setup process should be accomplished while the vehicle is parked and parking brake engaged.

First time Pairing

Pair this product with your Bluetooth device before you can make hands-free calls or stream music through Bluetooth.

Bluetooth pairing can be made through initial connection to CarPlay or Android Auto. Or follow the instructions below to complete it.

On your mobile device, go to **Settings > Bluetooth** then select “**Boss Audio BVCP9850W**” for pairing.

Follow the prompts on your mobile device and this product to complete Bluetooth pairing.

Enable Bluetooth Streaming/Phone

When CarPlay or Android Auto is connected to this product, Bluetooth streaming/phone will be disabled. In this case, you need to enable Bluetooth Bluetooth streaming/phone.

On the home screen, go to **SETTINGS > Device > Bluetooth Device** then touch the music or phone icon to enable Bluetooth streaming or phone.



For wired CarPlay or Android Auto connection, unplug the connection cable for use of Bluetooth streaming/phone.

When Bluetooth streaming/phone is enabled, CarPlay or Android Auto will be disabled. You can now make hands-free calls or stream music through Bluetooth (on the home screen, touch the “**STREAMING**” or “**PHONE**” icon to access Bluetooth streaming or phone).

Contacts and History

To Download Contacts:

1. Touch **Contact** to access download.

To Download History

1. Touch **History** to access download.

Device Status

Battery strength and signal strength is displayed on the top right of the home menu.



Phone

Calling

Making & Receiving Calls

1. Dialing from the dial pad

Touch  to make call

2. Contacts

Touch the contact name

3. History

Choose the name

To end a call **Touch** 

To mute a call **Touch** 

Dial Pad

To use the dial pad while on a call

Touch 

Searching History

To search, swipe Up or Down



History

1. Outgoing Call



2. Incoming Call





3. Missed



Private Mode

When a call needs to be transferred to the mobile device:

Touch  to switch the mobile device

Touch  to return to hands-free mode

Searching Contacts

Contacts must be downloaded to search.

1. **Touch** 

Call Waiting

To accept another call:

Touch 

To toggle between calls:

Touch  

NOTE

Active calls will be illuminated green

To **End** a call, **Touch** 

Default Settings

Bluetooth Power : **ON**

Auto Connect: **ON**

Auto Answer: **OFF**

Auto Download Phone book: **OFF**

Device Name: Boss Audio BVCP9850W

Audio

Audio Streaming

To play media through Bluetooth, the mobile device must be **Paired and Connected** to the BVCP9850W. See *pg. 19*.

If CarPlay or Android Auto is connected, you need to enable Bluetooth streaming on this product (on the home screen, go to **SETTINGS** > **Device** > **Bluetooth Device** then touch the music icon).

For wired CarPlay or Android Auto connection, unplug the connection cable for use of Bluetooth connection.

Touch



The music will play automatically.

Track Control

1. Play/Pause 

2. Track Fwd / Rev 

NOTE

For best performance, your mobile device volume setting should be set to maximum.

All volume adjustments for the system should be controlled from the product.

The unit will recall the last volume setting on your mobile device every time it connects.

Formats

Playback is supported from the mobile device with any format it can play.

Audio will only be played by the product.

Video cannot be viewed on the unit.

Display

Track info will be displayed when available.

Track, Album and Artist.

Album art supported via Bluetooth playback.

Media





USB

USB Playback



The music will play automatically.

Audio & Video Control

1. Play/Pause 
2. Track Fwd / Rev 
3. Repeat List 
4. Repeat File 
5. Random 

NOTE

If there are other files in the USB, music files will play first.

Navigating Menu

In the music playback interface, touch  to access the following menu options.





To browse contents **Swipe**



To return to the current file playing,

Touch

Photos

1. Play/Pause 
2. Fwd/Rev 
3. Rotate 

WARNING

Watching videos or photos while driving is against Federal, State, and Local laws.

Do not use features of this product if it cannot be operated safely and legally in your location.

NOTE

Review the connections of this product, to properly integrate the parking brake wire to the vehicle.

Video and or photos cannot be viewed while driving. The vehicle must be stationary and the parking brake applied to enable viewing.

Tuner

FM/ AM

Controls

Touch



Search

Tune to a station

Press < >.

Fine tune a station

1. Press and hold < > until "Manual" is displayed.
2. Press briefly < > to adjust radio frequency step by step.

NOTE

RDS/RBDS info (if available) and currently tuned station will display on the radio icon in the home screen.

Not all stations will have or display RDS/RBDS information.

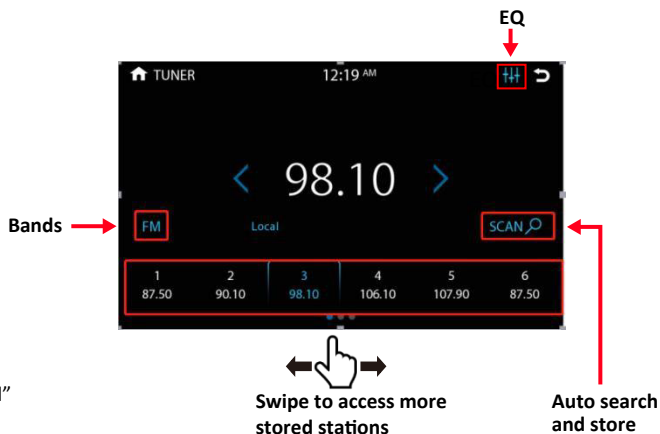

Local/DX

Touch "DX" or "Local" to switch between local and distant broadcasting stations.

"Local" to receive strong FM signals only.
"DX" to receive both weak and strong FM signals.

When an FM station with stereo is received, "ST" is displayed.

Select a band

Touch "FM" or "AM" to switch a radio band.

Access EQ settings

To access preset sound modes or customize frequency settings, touch .

AUX In/Camera

External Source

Playback (Audio Only)

Touch



Media must be controlled from the external device.

Track functions are not controlled from the product.

i NOTE

To adjust the volume level properly, the carry-in device volume should be set between 50 % - 75%. The volume level should remain at that level for the remainder of the time it is connected to the product.

! WARNING

Never rely solely on the rear view camera; always check your surroundings before proceeding.

Images may appear reversed

Do not use features of this product if it cannot be operated safely and legally in your location.

Front + Rear View

Rear and Front view camera can be displayed on demand.

Touch



To return to the Home screen

Touch



i NOTE

The **Camera Trigger Output** wire must be connected for Camera source to function.

Reverse View

When the vehicle is put into reverse gear, the camera will display the image on the screen.



Rear View Delay

Due to varying vehicle configurations, the rear view trigger or front view trigger can be delayed to best suit the vehicle.

See **Settings pg. 26**

Default setting: **0 Sec** Delay

i NOTE

The rear or front view camera will still function normally, if the product is in standby mode

Settings

Audio

System Tone



Default Setting: OFF

Loud

Enhances and gently boosts low and high freq.

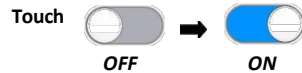

Default Setting: OFF

Subwoofer

The level and filter can be adjusted for the Sub pre-amp output.

Level, -8 - +8 dB

Default Setting: 0dB

Touch < >

Filter: 80 Hz, 120 Hz, 160 Hz @ 12dB/Oct

Touch < >

Volume

Settings are for default volumes for Hands- free. Media Player is a global setting for media.

Source Level

The level can be adjusted for the different source output.

Touch < >

Audio Effect

Preset EQ , User, Pop, Blues, classical, Jazz, Electronic, Rock, Country

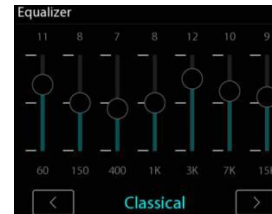

To select a preset sound mode

Touch < >

Balance/Fader

Left/Right Balance, Touch < >

Swipe for quick adjustment

Front/Rear Fader, Touch ^ v

Swipe for quick adjustment

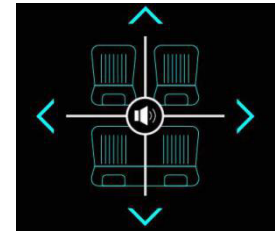

Settings

General

Date & Time

Time Zone

Set your time zone to display correct time.
The default: **(GMT-05:00) Eastern Time (US)**

Date

Set manually year/month/day.

Time

Set manually hours and minutes.

24H Mode

Set 24-hour or 12-hour display.

Auto Adjust

Enable or disable automatic time accuracy correction when Apple CarPlay is connected.

Android Auto

Auto Launch

Enable or disable automatic Android Auto activation when Android Auto is connected.

Camera Settings

Camera Trigger

Enable or disable trigger of rear/front camera view when your vehicle is in reverse gear.

Rear Camera

Enable or disable rear camera signal input.

Front Camera

Enable or disable front camera signal input.

Camera Power

Enable or disable power connection to camera.

Rear/Front Camera Delay

Delay trigger of camera view off by a set time (1/2/3 seconds, or off) upon disengagement of the reverse gear.

ACC OFF

Radio off after 1 minute

Enable or disable trigger of the unit off one minute later when your vehicle is turned off.

Retain ACC Power

Delay trigger of the unit off by a set time (1/2/3 seconds, or off) when your vehicle is turned off.

Language

Select a display language for menu.

Wallpaper

Select a background picture for home screen.

Restore Factory Settings

Restore the unit to the factory settings.



All settings and presets will be cleared after restoring to the factory settings.

Advance Settings

Input "0000" to access the advance settings.

Enable Trajectory

If your camera does not have parking guide, enable the function to display parking guide. Otherwise, disable the function.

Screenshot Control

Enable screenshot taking function.
Press briefly the power button on the front panel, then the screenshot is taken and saved in the connected USB device.

Static Trajectory Adjust

If you enable parking guide (Enable Trajectory), you can adjust on-screen parking guidelines. Touch and drag a circle icon on the screen to reposition the related guideline. To fine tune positioning of the guideline, repeatedly touch an on-screen arrow icon. To reset the guidelines, press the reset icon on the screen.

Driving Seat

Select "Right" or "Left" to position the CarPlay menu bar on the right or left side of the screen. To activate the change, you need to unplug the iPhone from the head unit and re-plug it.

Disclaimer

Enable to display the safety warning message each time the head unit starts up.

Settings

Illumination

Day Brightness

Touch < >

Adjust day mode brightness value.

Night Brightness

Touch < >

Adjust night mode Brightness.

When the vehicle lights are on, the products illumination will be changed to night use automatically.

Screen and LED brightness settings for this

Gamma

Touch < >

Gamma can be adjusted for both day and night settings.

LED Animation

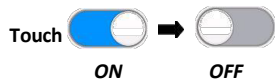

Will cycle through all colors on LED

Default Setting: ON

LED Color



Adjust button lights in different colors.

Illumination Default

To restore Illumination settings to default.

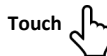

Will restore all display settings.

Bluetooth Device



Bluetooth device search.

Apple CarPlay Device

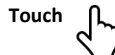

Wireless Apple CarPlay device search.

Bluetooth Setting

Bluetooth Power



Default Setting: ON

Device

NOTE

Bluetooth will turn OFF automatically when CarPlay or Android Auto is connected. If other devices are connected via Bluetooth, they will be disconnected for CarPlay/Android connection.

To enable Bluetooth connection, on the home screen, go to **SETTINGS > Device > Bluetooth Device** then touch the music or phone icon to enable Bluetooth streaming or phone.

For wired CarPlay or Android Auto connection, unplug the connection cable for use of Bluetooth connection.

Auto Connect

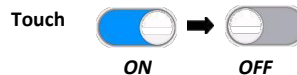

Auto connect to the device when the product is powered ON

Default Setting: ON

Auto Answer



Auto answer when there is an incoming call.

Default Setting: OFF

Settings

Device

Auto Download

Phone Book



Automatically download phone book.

Default Setting: **OFF**

Manual Download Phone Book



Manual Delete Phone Book



Device Name



Default name:

Boss Audio BVCP9850W

Reset WIFI Password



Radio

Seek Quality FM/AM

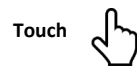

Adjust the **sensitivity** of both AM/FM bands.



Will reset the seek sensitivity to back to default.

Region



Default Setting: **America 2**

US Tuner Spacing: FM (200 KHz), AM (10 KHz)

European Spacing: FM (50 KHz), AM (9 KHz)

RDS/RBDS, Radio Broadcast Data System



Default Setting: **ON**

Allows data from the radio station to be displayed on the product.

RDS/RBDS

Not all stations will broadcast information to display.

AF (Alternative Frequency)



When **On**, the tuner will automatically locate the same tuning program on other stations and select the strongest signal of those being broadcast.

Default Setting: **OFF**

TA (Traffic Announcement)



The radio will automatically tune in to traffic information broadcasts while receiving FM broadcasts playing media.

Default Setting: **OFF**

Auto Preset

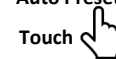

Automatically search and preset stations.

Settings

About

Displays the system information:

The screenshot shows the 'About' section of the Settings app. The interface is dark-themed. At the top, there is a home icon, the word 'SETTINGS', the time '12:00 AM', and icons for accessibility and search. Below this is a list of settings categories on the left: General, Audio, Illumination, Device, Radio, and About (highlighted in cyan). The main area displays system information with red arrows pointing to labels on the right:

| | | |
|-------------------|------------------------|-------------------|
| Hardware Version | V1.0.3 | Hardware Version |
| Software Version | BVCP9850W_V1.0.8.1... | Software Version |
| Bluetooth Version | V1.34 | Bluetooth Version |
| BT MAC | B0:20:81:EC:6E:7B | BT MAC |
| Serial Number | 5c0b:6e93:0004:4184... | Serial Number |
| USB NCM MAC | 00:00:00:00:00:00 | USB NCM MAC |

NOTE

Software version information depends on the software used for production.

Connections

Power and Steering Wheel Control (SWC) Wiring

CAUTION

Always replace the faulty fuse with the same type and rating (15A).

Constant/Accessory power input is rated at 12V.

Antenna output is rated at 500mA max. It is recommended to use a relay if additional power is required.

NOTE

Unused input/output wires need to be insulated with tape, heat shrink, or crimp connectors. Never use wire nuts.

Illumination input wire (orange) must be connected to the parking light for screen dimming adjustment at night.

Reverse Input wire (Purple/white) must be connected to the reverse light wire for the backup camera trigger when the gear is switched to reverse.

A separate interface might be needed for your vehicle application. It is recommended that you consult with a professional installer.

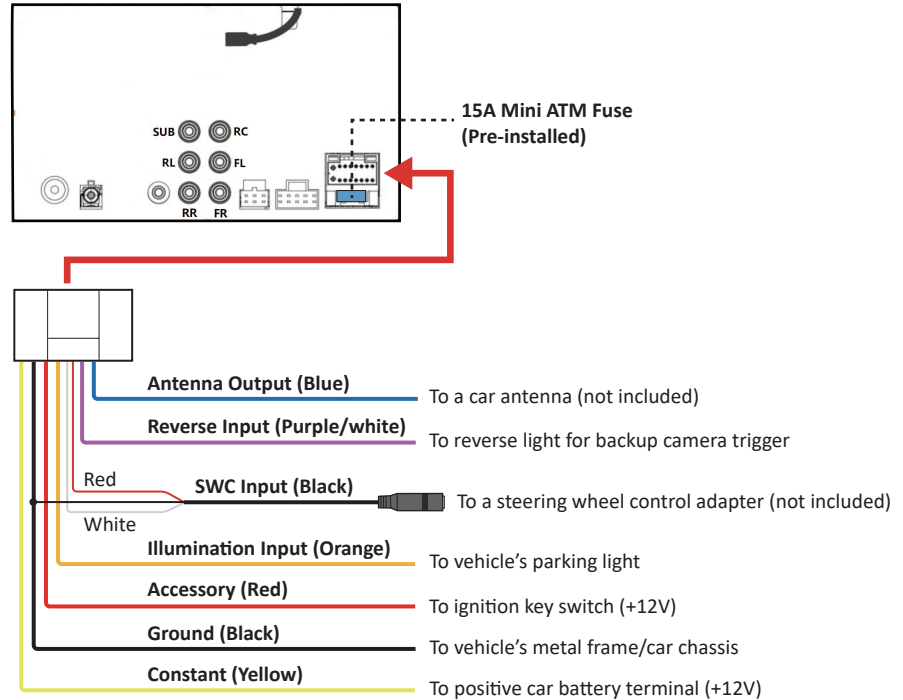

Connections

Speaker Wiring

CAUTION

Do not chassis ground any speaker wire leads.

Only use 4-8 Ω speakers.

DO NOT use 1-3 Ω speakers.

Do not bridge any of the channels. They are only to be wired in stereo mode.

NOTE

Unused speaker wires need to be insulated with tape, heat shrink, or crimp connectors to avoid damage to the unit. **Never use wire nuts.**

Double check speaker polarity when making connections.

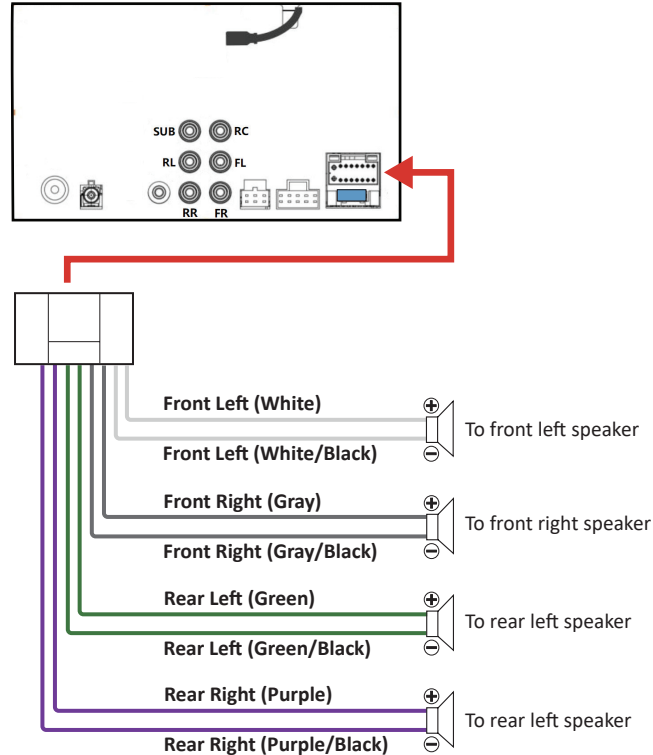

Connections

Parking Brake and Amplifier Remote Output Wiring

WARNING

Improper connection or use of the parking brake status wire (e.g. defeating the safety feature) violates Federal, State, and Local laws. This may lead to injury, property damage, and/or death.

Watching videos or photos while driving is against Federal, State, and Local laws.

CAUTION

Remote output is rated at 500mA max. It is recommended to use a relay if additional power is required.

NOTE

For Android Auto setup, the parking brake status wire **MUST** be connected.

Review the connection of this product to properly integrate the parking brake wire to the vehicle.

Video and photo cannot be viewed while driving. The vehicle must be stationary and the parking brake applied to enable viewing.

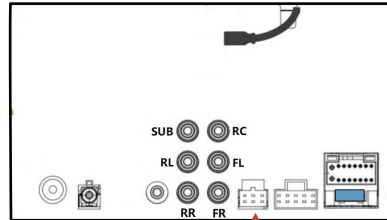

AMP Remote Output (Blue/white)

To power terminal on an amplifier (not included)

Parking Brake Input (Light green)

To vehicle's parking brake switch

NOTE

Parking brake wire location varies from vehicles. Consult a certified professional installer

Connections

Camera/USB/Audio/Radio/Mic

- Using a lightning cable or USB cable, connect your iPhone or Android device to enable use of CarPlay or Android Auto.
- Connect to a USB flash drive for media play.
- Connect and charge your mobile phone.

Connect a FM/AM radio antenna (not included).

Connect the supplied GPS antenna for auxiliary Android Auto/CarPlay navigation.

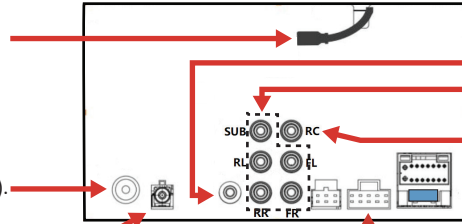

Connect the supplied hands-free microphone.

Connect an amplifier (not included) for pre-amp audio output.

Connect a rear camera for video signal input

WARNING

Never rely solely on the backup camera. Always check your surroundings before backing up.

Images may appear reversed if your camera is not properly installed or set up.

Do not use features of this unit if it cannot be operated safely and legally in your location.

NOTE

Subwoofer pre-amp output is a non-fading mono output.

Always run signal wires away from power cables to reduce the possibility of noise.



Front Cam Power Output (Red/Purple)

To a front camera (not supplied) for power output

Rear Cam Power Output (Red/White)

To a rear camera (not supplied) for power output

Left AUX Input



To RCA audio outputs on an audio playback device (e.g. a CD or external media receiver) *

Right AUX Input



Front Camera Input



To a front camera for video signal input

* Or using a RCA to 3.5mm/USB-C/lightning adapter (not included), connect the AUX input to the audio output on your mobile phone.

Connections

Hands-free Mic Installation

Placement

The unit comes with a hands-free microphone. The location of the microphone can vary from different vehicles due to layout, interior materials, etc.

The **Red** shaded areas are the recommended locations for best microphone performance.

Items to look for before placement:

1. Do not place in front of air vents.
2. If the vehicle has tweeters placed on sail panel, do **NOT** locate the microphone on steering column area.
3. The front of the microphone must not be blocked.
4. Microphone should be firmly attached to mounting location.
5. Do not cover the grille openings surrounding the microphone.
6. To avoid excessive wind noise, do not place near the sunroof opening.

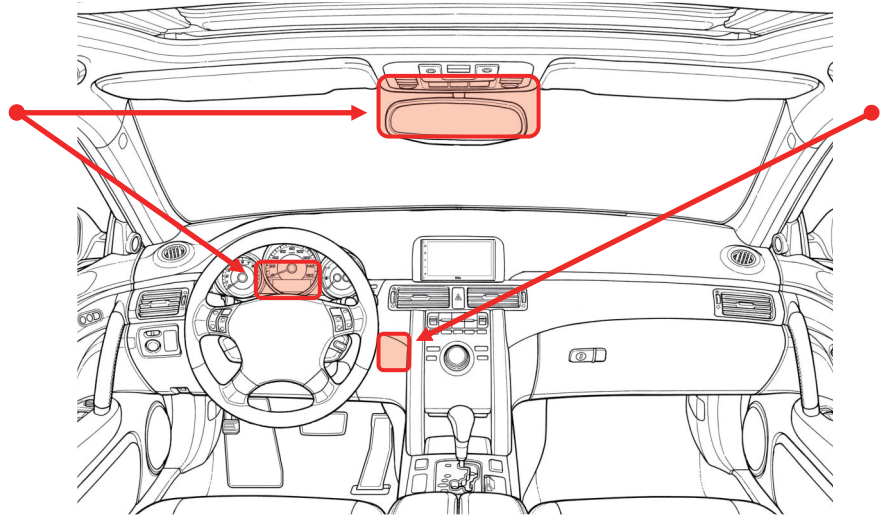

WARNING

Run the microphone wire where it will **NOT** impede with the operation of any safety items (e.g. airbags, knee airbags, etc.)

Steering Wheel Control Compatibility

Using SWC

SWC Introduction

Steering Wheel Control (SWC) function allows you to operate this unit via an external device (steering wheel control).

A third-party adapter must be used in order for this unit to be compatible with your OEM steering wheel controls. We recommend PAC SWC series.

This unit has a built-in 3.5mm SWC interface that is compatible with many popular 3rd party SWC control modules, such as PAC, METRA, and others.

3.5mm SWC input (black socket) is located on the supplied wire harness which is connected to the rear of the unit.

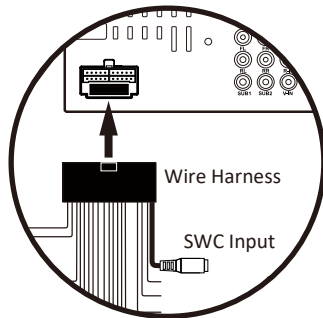

Illustration for reference only

Programmable Controls

The following radio / audio function controls are available to be programmed.

Source
Mute
Home
Seek + / Next Track
Seek - / Previous Track
Volume +
Volume -
Band
Phone Menu
Bluetooth Talk
Bluetooth End Call
Voice Assistant / PTT

Note

Not all OEM steering wheel functions may be supported.
Specifications are subject to change without notice.

SWC Installation / Programming

Contact your local installation expert for the correct SWC adapter for your specific vehicle.

1. For most SWC adapters, select program using "Pioneer/Sony/Other" mapping order as described in "Programmable Control".
2. When programming, if a function is not supported (or not desired), then the function **MUST** be skipped as per the SWC module instructions.
3. The SWC function **MUST** be programmed in the correct order as per the function mapping order instructions.

Note

For SWC programming technical assistance, call the number in your SWC instruction manual.

Troubleshooting

| Issues | Cause | Solution |
|---|---|---|
| No Sound | Product is muted External amplifiers Audio source | Touch the volume. Check the external amplifiers are on. Change the audio source |
| Media Not Supported | Media on USB flash drive | Change the media format on the USB device. Change the USB device. |
| Bad Radio Reception | Radio area Antenna | Go to Settings > Radio > Sensitivity Adjust AM/FM Sensitivity Change the station Turn OFF AF and TA Turn OFF RDS/RBDS Antenna output wire is not connected. Connect an antenna to the unit. |
| Apple CarPlay/Android Auto unable to start | Bad lightning/USB cable Wi-Fi or Bluetooth disabled Wireless CarPlay/Android Auto connection disabled | Replace the cable for wired connection. Enable Wi-Fi and Bluetooth on your phone. Allow wireless CarPlay/Android Auto use when prompted during first time connection/pairing. For CarPlay use, make sure CarPlay is enabled on your iPhone (Settings > General > CarPlay > Paired device > Open CarPlay). Enable CarPlay/Android Auto connection (on the home screen, go to SETTINGS > Device > Bluetooth Device then tap the phone name. |
| Bluetooth streaming/phone call not possible | Bluetooth connection disabled | Make sure your mobile device is within range. Enable Bluetooth on your mobile device. |

Troubleshooting

Issues

Bluetooth streaming/phone call not possible

Cause

Bluetooth connection disabled

Solution

Enable Bluetooth connection (on the home screen, go to **SETTINGS > Device > Bluetooth Device** then tap the music or phone icon to enable Bluetooth streaming or phone).

For wired CarPlay/Android Auto connection, unplug the connection cable.

Hands-free call quality

Mobile device

Check cellular strength on mobile device.
End call and redial number.

Microphone

Microphone placement needs to be relocated.
Microphone needs to be firmly attached to location it's mounted on.
Check to see if microphone is properly plugged in.



If you have questions about this product:

Customer Service

805-751-4853

M-F 8:30a-5:00p (PST)

Tech Support: www.bosssaudio.com/support/technical-support

BVCP9850W

© 2023 BOSS Audio Systems

Specifications

General

| | |
|------------------------------|----------------|
| Power Input..... | 10.8 V—16 V DC |
| Nominal..... | 14.4 V DC |
| Current Consumption..... | 10 A (Max) |
| Fuse Type..... | 15 A, Mini-ATM |
| Dimensions (H x W x D)..... | 4" x 7" x 6.5" |
| Unit Weight..... | 3.1 lbs. |
| Operational Temperature..... | -4—158°F |

Display

| | |
|-------------------|-----------------------|
| Screen Size..... | 6.75" |
| Aspect Ratio..... | 16:9 |
| Resolution..... | 480 x 800 |
| Screen Type..... | TFT-LED Active Matrix |

Audio

| | |
|------------------------------|----------------|
| Max Power..... | 80 W x 4 |
| Acceptable Speaker Load..... | 4-8 Ω |
| Preset EQ..... | 8 |
| EQ Boost/Cut..... | ± 7 dB |
| Pre-amp Output..... | 4.1 |
| Front..... | 2V, Full-Range |
| Rear..... | 2V, Full-Range |
| Sub (Mono)..... | 2V, LFP |

Audio

| | |
|----------------|----------------------------------|
| Sub LPF..... | 80 Hz, 120 Hz, 160 Hz @ 12dB/Oct |
| Sub Level..... | -8 - +8dB |

Radio Tuner

| | |
|------------------------|--------------------------|
| Freq. Range..... | 87.5 MHz-108 MHz (FM) |
| Freq. Range..... | 522 kHz-1710 kHz (AM) |
| USA 1 Range (FM)..... | 100 kHz Spacing |
| USA 2 Range (FM)..... | 200 kHz Spacing |
| Europe Range (FM)..... | 50 kHz Spacing |
| RDS/RBDS | AF, TA |
| S/N Ratio (FM)..... | 60 dB (Analog Broadcast) |
| S/N Ratio (AM)..... | 45 dB (Analog Broadcast) |
| Sensitivity..... | 30 dB |

Apple CarPlay

| | |
|---------------------|-------------------|
| iPhone Support..... | iPhone 5 or Newer |
| iOS..... | iOS 7.1 or Newer |

Android Auto

| | |
|---------------|-----------------------|
| Wired..... | Android 6.0 or Newer |
| Wireless..... | Android 11.0 or Newer |

USB

| | |
|--------------------------|---|
| USB Spec..... | USB 2.0 (High-Speed) |
| USB Current Output..... | 2A (Max) |
| File System..... | FAT32 |
| Audio Playback..... | MP3, WMA, WAV, FLAC (24 bit/192 kHz) |
| Video Playback..... | AVI, MKV, MOV, WMV |
| Picture Playback..... | JPG, PNG, BMP |
| Flash Drive Support..... | up to 128GB |

* Not all listed compressed files guaranteed to play due to different creation methods or file contents.

Bluetooth®

| | |
|-------------------|--|
| Version..... | v3.0+E.D.R. |
| Audio Code..... | S.B.C. |
| Profiles..... | A2DP v1.2, AVRCP v1.4, GATT v1.0, HFP v1.5, PBAP v1.0 |
| Output Power..... | Class 2 |
| Up to | 33 ft (10m), Free-range |

Wi-Fi

| | |
|---|-------|
| Frequency Band..... | 5 GHz |
| (Only used in wireless connection for CarPlay and Android Auto) | |

Specifications are subject to change without notice.



BOSS Audio Systems
3451 Lunar Court • Oxnard, CA 93030
www.bossaudio.com
805-751-4853 Customer Service
Tech Support: www.bossaudio.com/support



0323

iPhone® is a trademark of Apple Inc., registered in the U.S. and other countries. Apple CarPlay is a trademark of Apple Inc. BOSS Audio Systems is not affiliated with Apple Inc.

The Bluetooth™ word mark and logos are registered trademarks owned by Bluetooth SIG, Inc. and any use of such marks by BOSS Audio Systems is under license. Other trademarks and trade names are those of their respective owners.

Android Auto is a trademark of Google LLC.

Use of the Apple CarPlay logo means that this user interface meets Apple performance standards. Apple is not responsible for the operation of this device or its compliance with safety and regulatory standards. Please note that the use of this product with iPhone may affect wireless performance.