



SEKONIC

FLASHMATE

L-308S

Operating Manual

SAFETY PRECAUTIONS

This manual uses the following safety labels for  **WARNING** and  **CAUTION** that you must follow.

 **WARNING** Indicates hazards or unsafe practices that can result in severe personal injury or death.

 **CAUTION** Indicates hazards or unsafe practices that can result in the personal injury or damage to your L-308S exposure meter.

NOTE: Indicates a caution or limitation that accompanies operation. Please read the note to avoid incorrect operation.

REFERENCE: Provides the reference information and related functions that are useful in operating the L-308S. We recommend that you read these reference.

 **WARNING**

- Please place in a location where an infant cannot reach and accidentally get the strap wrapped around his or her neck. There is danger of strangulation.
- Keep the Lumidisc and synchro terminal cap out of reach of young children, as swallowing such objects can cause suffocation.
- Never place batteries in fire, short disassemble heat or charge them. The batteries might break down, and cause an accident, injury or pollute the environment.

 **CAUTION**

- There is a danger of electric shock if the meter is handled with wet hands, during rain, in areas splashed by water or where there is a lot of moisture, if you use cord flash mode. Also, such action may damage the product.

Safety Precautions

Table of Contents

1. Parts Designation	1
2. Explanation of the Liquid Crystal Display (LCD)	2
3. Before Using	3
1. Attach the strap	3
2. Inserting the battery	3
3. Checking battery capacity	4
4. Replacing battery during measurement	4
5. Auto Power OFF function	5
6. Setting ISO film speed	5
4. Basic Operation	6
1. Incident or reflected light measuring	6
2. Setting measuring mode	6
3. When set for incident light	8
4. When set for reflected light	9
5. Measurement	10
1. Measuring Ambient Light	10
1-1 Shutter Speed Priority mode	10
1-2 EV mode	11
1-3 Cinematography	13
2. Measuring Flash Light	14
2-1 Cord Flash mode	14
2-2 Auto Reset Cordless Flash mode	16
6. Advanced Functions	18
1. Measuring Light Contrast	18
2. How to use an incident illuminance (LUX or FC) meter	19
3. Custom setting function	20
7. Accessories	21
8. Technical Data	22
9. Safety Guide and Maintenance	23

1. Parts Designation

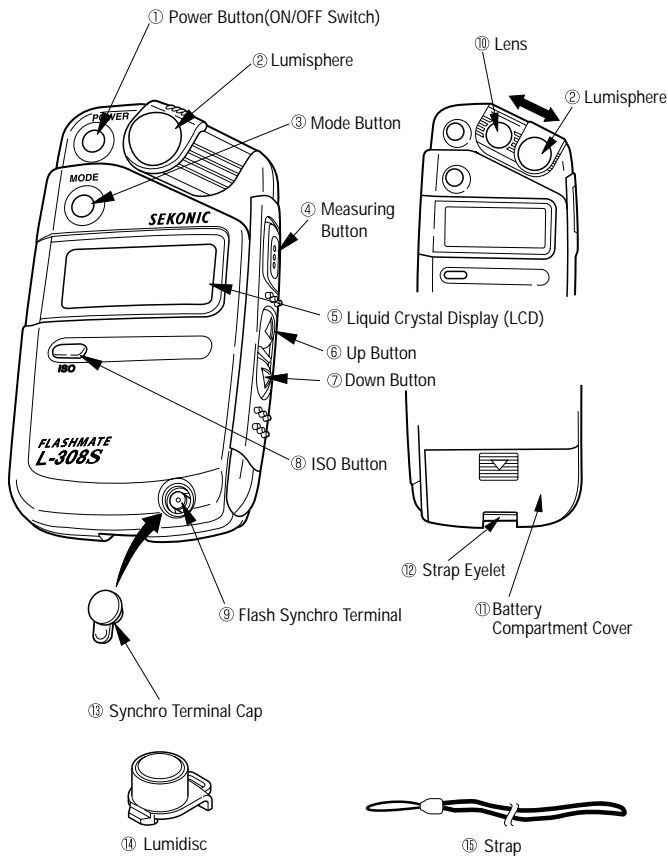

2. Explanation of the Liquid Crystal Display (LCD)

* For explanation purposes, the display illustrated here shows icons and readouts simultaneously. Actual display will never appear like this.

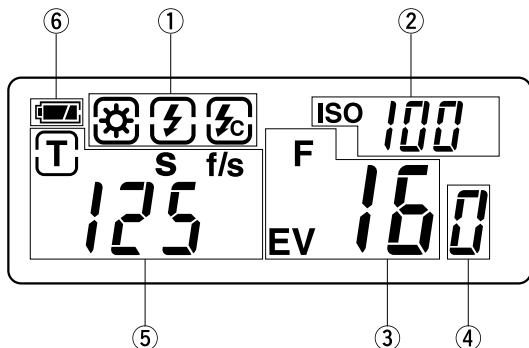

① Measuring Mode icons

- Ambient (See page 10)
- Auto Reset Cordless Flash (See page 16)
- Cord Flash (See page 14)

② ISO Display (See page 5)

ISO Displays ISO Film setting.

③ Aperture/EV display

F Appears when aperture value is displayed.

EV Appears when using EV mode. (See page 11)

④ 0.1 step display

Depending on set mode, this displays measurement value at 1/10 aperture or 1/10 EV. (See page 10)

⑤ Shutter Priority indicator, Shutter speed display for still photography or frames per second (f/s) for cinematography

Appears when Shutter Priority (T) mode. (See page 10)

S Appears when shutter speed is in full seconds. (See page 10)

f/s Appears when cine speed is set in frames per seconds. (See page 13)

⑥ Battery Power Indicator (See page 4)

3. Before Using

1. Attach the strap

- 1) Attach the Strap ⑮ by passing the small end loop through the strap eyelet ⑫ and passing the other end of strap through it.

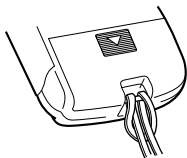

WARNING

- Please place in a location where an infant cannot reach and accidentally get the strap wrapped around his or her neck. There is danger of strangulation.

2. Inserting the battery

- 1) Requires type-AA 1.5-volt manganese dry cell battery (R6P) or type-AA 1.5-volt alkali dry cell battery (LR6) or type-AA 1.5-volt lithium dry cell battery (FR6).

Do not use any battery other than the designated types.

- 2) Slide down the battery compartment cover ⑪ in the direction of the arrow to remove.
- 3) Insert the battery observing the polarity with the +, - marks in the battery compartment.
- 4) Align battery compartment cover with main unit and slide shut.

Make sure that the cover is properly in place and closed.

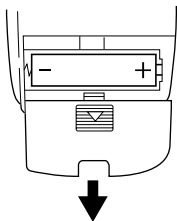

NOTE:

- Nickel and cadmium storage batteries (NiCd) and nickel and hydrogen batteries (NiH) cannot be used.
- Remove battery if meter is not used for an extended period. Batteries can leak and damage the exposure meter. Dispose of used batteries properly.
- If the LCD does not light, check that the battery capacity is sufficient, and check that the battery positive and negative terminals are not reversed.

3. Checking battery capacity

When the Power button ① is ON, the battery power indicator on the LCD ⑤ is displayed.



(Displayed) Battery power level is good.



(Displayed) Battery power level is low. Have a spare battery ready.



(Blinking) Replace battery immediately.

REFERENCE:

- If the liquid crystal display extinguishes immediately after the display appears when power is first applied, that is an indication that the battery is dead. Please promptly replace the battery.
- In case of continuous measuring, the battery life of this unit is as below in normal temperature.
Manganese dry cell about 10 hours
Alkali dry cell about 20 hours (according to our test condition)
- The battery accompanying with this unit when you purchased might die with in less than the above battery life because it is for sample-use.

4. Replacing battery during measurement

- 1) Always turn the power OFF before replacing batteries. If batteries are removed with the power ON, measurements and settings can no longer be recalled.
- 2) If after replacing the battery, or during measurements, strange screens (displays that have not been set) appear in the LCD, or nothing happens, no matter what button is pushed, remove the battery and wait at least ten seconds and then replace the battery. This allows the software to automatically reset.

WARNING

- Never place batteries in fire, short, disassemble, heat or charge them. The batteries might break down, and cause an accident, injury or pollute the environment.

NOTE:

- A three second pause between power ON and OFF is recommended to avoid damage to the meter.

3. Before Using

5. Auto Power OFF function

- 1) To conserve battery power, the meter will turn OFF about four minutes after last use.
- 2) Whether the Auto Power OFF function turns the power OFF or the Power button ① is pressed, the settings and measured values remain stored in memory. When the Power button is pressed again the last settings are displayed.

REFERENCE:

- The power shuts OFF automatically after one minute when the power button is pressed and held.

6. Setting ISO film speed

- 1) Hold down the ISO button ⑧ and press either the Up button ⑥ or Down button ⑦ to select ISO film speed for the film being used.
- 2) You can also change the ISO film speed after taking measurements. The new value is automatically displayed.

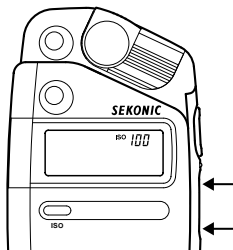

REFERENCE:

- Setting value will change consecutively if the Up button or Down button is depressed for one second or longer.

1. Incident or reflected light measuring

- 1) To set for either incident or reflected light operation, slide the Lumisphere ② mounting until it clicks.

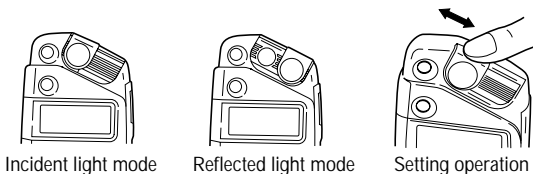

NOTE:

- Always use the Lumisphere mounting for setting. Hand operation of the Lumisphere may cause damage.
- The Lumisphere is an important light receiving unit. Please handle with care and try not to mark or soil. Wipe Lumisphere with a dry soft cloth if it becomes dirty. Never use organic cleaners (like thinner or benzene) to clean Lumisphere.

2. Setting measuring mode

- 1) Press the Mode button ③ to select a mode. The mode switching sequence is as follows.

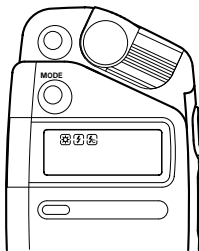
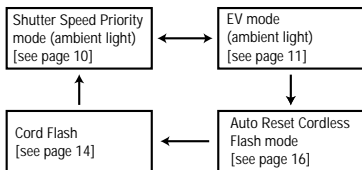

4. Basic Operation

- 2) Interchangeably switch between EV mode and Shutter Speed Priority mode by pressing the Mode button (3) while holding down the ISO button (8) in Ambient mode. Measurement value also will be automatically calculated when a switch is made after measuring.

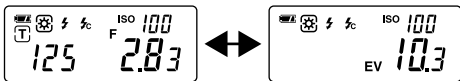
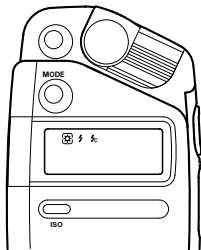

REFERENCE:

- Ambient light refers to continuous light like natural light (sunlight), tungsten lamps or fluorescent lamps.
- Flash light is a brief, intense burst of light made by such as electronic flash units or flash bulbs.

3. When set for incident light

Incident light measuring is the measurement method that employs either the Lumisphere or Lumidisc functions.

Measure with the lumisphere aimed in the camera direction at the position of the subject.

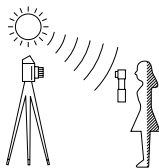

1) Using Lumisphere to Measure

Lumisphere is used to measure people and buildings and other such solid objects. Measurements are basically made by the method of measuring with the Lumisphere aimed in the camera direction (more precisely, in the direction of the lens axis) at the position of the subject.

2) Using Lumidisc to Measure

This is used to measure manuscripts, paintings or other flat copy, or otherwise for measuring light contrast (see page 18) or using as an illuminometer. To switch to the Lumidisc function, slide the Lumisphere mounting to the right (same as if measuring reflected light), insert at an angle section B of the Lumidisc into slot A of the light receiver and then press down the strap eyelet C to secure the Lumidisc.

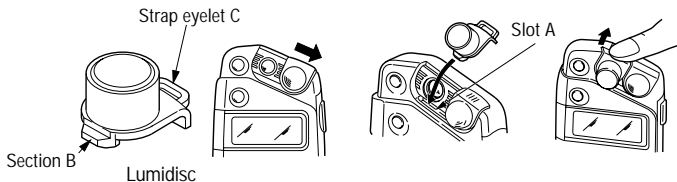

The Lumidisc is removed in reverse order to the mounting method.

At this time the strap eyelet of the Lumidisc should be pulled away from the main unit.

NOTE:

- Be sure to handle the Lumidisc correctly to prevent damage that may occur if mounting or removal is incorrect.
- Do not fit the Lumidisc next to the Lumisphere when you take incident light metering. Otherwise, the Lumidisc will affect the exposure in reading.
- The Lumisphere is an important light receiving unit. Please handle with care and try not to mark or soil. Wipe Lumisphere with a dry soft cloth if it becomes dirty. Never use organic cleaners (like thinner or benzene) to clean Lumisphere.

4. Basic Operation

4. When set for reflected light

Point the lens of the exposure meter toward the part of the subject to be measured from the camera position or from the camera direction and then measure.

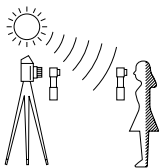

- 1) This method is used to measure the brightness (luminance) of light reflected from the subject and is useful for metering subjects that cannot be approached or light-generating subjects (neon signs, etc.), highly reflective surfaces or translucent subjects (stained glass, etc.).
- 2) Point the lens of the exposure meter toward the part of the subject to be measured from the camera position or from the camera direction and then measure.

NOTE:

- If you measure from the camera position, the entire object is measured in average.
- If you want to measure only part of the object, do it at as close a position as possible to the part to be measured. Take care not to cast a shadow with the meter, etc. into the part to be measured.
- The lens is an important light receiving unit. Please handle with care and try not to mark or soil.
Wipe Lumisphere with a dry soft cloth if it becomes dirty.
Never use organic cleaners (like thinner or benzene) to clean Lumisphere.

1. Measuring Ambient Light

In this measurement mode, we have the choice of shutter priority mode and EV mode. Press the Mode button (3) to select the  Ambient mode.

1-1 Shutter Speed Priority mode

- 1) Press the Mode button to select the  Shutter Speed Priority mode.
- 2) Press the Up button (6) or Down button (7) to set the desired shutter speed.
- 3) Press the measuring button (4) to make a measurement. Release the measuring button to complete measurement. The measured value (aperture value) at that time will be displayed.

While pressing the Measuring button, the meter measures continuously until it is released.

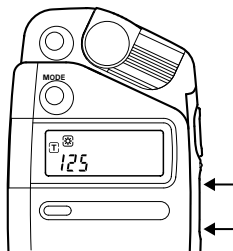

1/10 step measurement value (f stop)

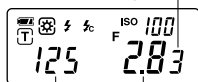

Set shutter speed

Measurement value (aperture value)

REFERENCE:

- It is possible to switch between full, 1/2 or 1/3 shutter speeds with custom setting (see page 19).
- You can set shutter speeds from 60 sec, 50 sec, 45 sec, 1 sec, 0.8 sec through to 0.3sec, 1/4 through to 1/6400 sec and 1/8000 sec. After 1/8000 sec, the cine speed of 8f/s through to 128 f/s can be set.
- After measurement, the F stop value corresponding to the shutter speed is displayed when the shutter speed changed.
- If ISO film speed is altered after measuring, a corresponding aperture value will be displayed.
- Even if within the measurement range of the L-308S, the exposure over symbol E.o may appear for the set shutter speed at maximum aperture value (F90) and likewise the exposure under symbol E.u may appear at the minimum value (F0.5). If either of these symbols appears, please take the next page action.

5. Measurement

- ☆ When the display range is exceeded, and E.o appears, press the Up button ⑥ to change the shutter speed to the high-speed side and thus enable an appropriate corresponding aperture value to be displayed.

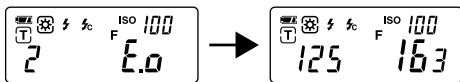

- ☆ When the display range is exceeded, and E.u appears, press the Down button ⑦ to alter the shutter speed to the slow-speed side and thus enable an appropriate corresponding aperture value to be displayed.

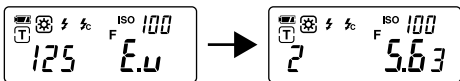

- NOTE:**
- When brightness (or darkness) exceeds the measuring range of the L-308S, E.o (or E.u) will blink to indicate that measuring is not possible. In such cases please adjust brightness.



1-2 EV mode

- 1) Press Mode button ③ to select **EV** mode.

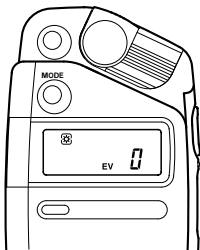

5. Measurement

- 2) Press measuring button ④ to make a measurement. Release the measuring button to complete the measurement. The measured value (EV value) at that time will be displayed.

While pressing the measuring button, the meter measures continuously until it is released.

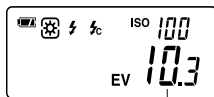

Measurement value (EV)

REFERENCE:

- EV (exposure value) is the reading that logarithmically expresses the constant quantity of light combined from the shutter speed and aperture value.
With 1 EV change the quantity of light doubles (or halves).
- The relationship between aperture value (AV), shutter speed value (TV = Time Value) and EV is $EV = AV + TV$. From this relationship formula, the number of ways that the aperture and shutter speed can be combined against a certain constant EV can be calculated.
- With the ambient light Shutter Speed Priority mode, if the Up and Down buttons are pressed after measuring, the shutter speed value will change and in accompaniment of that an appropriate aperture value (measuring value) will be displayed.

☆ Aperture Value & Shutter Speed Value, EV Contrast Table

$$EV = AV + TV$$

		AV											
		0	1	2	3	4	5	6	7	8	9	10	
TV		1.0	1.4	2.0	2.8	4.0	5.6	8.0	11	16	22	32	
	0	1s	0	1	2	3	4	5	6	7	8	9	10
	1	1/2	1	2	3	4	5	6	7	8	9	10	11
	2	1/4	2	3	4	5	6	7	8	9	10	11	12
	3	1/8	3	4	5	6	7	8	9	10	11	12	13
	4	1/15	4	5	6	7	8	9	10	11	12	13	14
	5	1/30	5	6	7	8	9	10	11	12	13	14	15
	6	1/60	6	7	8	9	10	11	12	13	14	15	16
	7	1/125	7	8	9	10	11	12	13	14	15	16	17
	8	1/250	8	9	10	11	12	13	14	15	16	17	18
	9	1/500	9	10	11	12	13	14	15	16	17	18	19
10	1/1000	10	11	12	13	14	15	16	17	18	19	20	

- * Horizontal axis is for aperture values and the vertical axis is for shutter speed values. The numbers on gray is EV.

5. Measurement

1-3 Cinematography

- 1) Press Mode button ③ to select Shutter Speed Priority mode.

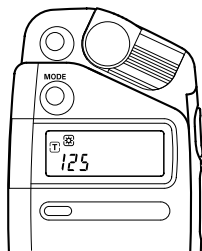

- 2) Press the Up button ⑥ or Down button ⑦ to select the cine speed for the camera that will be used.

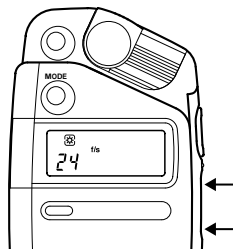

The following cine speeds will be displayed after 1/6000 and 1/8000: 8, 12, 16, 18, 24, 25, 30, 32, 60 and 128 fs. The shutter angle that these speeds are based on is 180 degrees.

2. Measuring Flash Light

This measuring method comprises the cord and cordless flash modes. Measure the flash light to display shutter speed and aperture value (total amount of light combining ambient light and flash light) on the LCD.

2-1 Cord Flash mode

This measuring method is used to make sure synchronization with flash units, or to measure flash bulb by connecting Synchro cord.

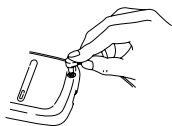

- 1) Connect the flash synchro cord to the flash synchro terminal ⑨ on the exposure meter.
- 2) Press Mode button ③ to select  cord flash mode.
- 3) Press the Up button ⑥ or the Down button ⑦ to set the shutter speed. When setting shutter speed, first check the settings to confirm that they correspond to the settings on the camera.

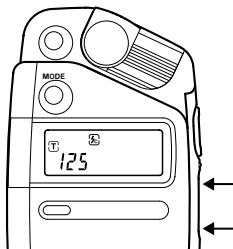

- 4) Press the measuring button ④ to trigger the flash. The measurement value (f stop value) will be displayed.

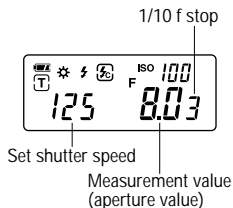

WARNING

- Please place in a location where an infant cannot reach and accidentally swallow the synchro terminal cap. There is danger of strangulation.

5. Measurement

NOTE:

- There is a danger of electric shock if the meter is handled with wet hands, during rain, in areas splashed by water or where there is a lot of moisture, if you use cord flash mode.
- The electronic flash unit may trigger when you connect the synchro cord or operate the Power button.
- For flash unit with an extremely low trigger voltage, the flash may not fire. In this case, make measurements in auto reset cordless flash mode. (See page 16)
- When triggering a flash bulb to take measurement, please check the cameras synchronizing range and set the proper shutter speed.

REFERENCE:

- It is possible to switch the shutter speed between full, 1/2 or 1/3 stops by custom setting (see page 19).
- Shutter speed can be set from 1sec, 0.8sec through to 0.3 sec, 1/4 through to 1/500 sec and followed by 1/75, 1/80, 1/90 and 1/100.
- After measuring, if the shutter speed is changed, the measurement value (aperture value) will revert to zero. In such cases please measure again.
- If ISO film speed is altered after measuring, a calculated value (aperture value) will be displayed.
- Even if settings are within the measurement range of the L-308S, the E.o or E.u symbol may appear for the aperture value corresponding to the set shutter speed.
Change the shutter speed or measure again using the following methods.

- ☆ When the display range is exceeded (E.o), press the Up button (⑥) to change the shutter speed to the high-speed side within the synchronizing range of the camera, or lessen the quantity of flash light and measure again to display a measurement value (aperture value).

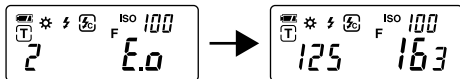

5. Measurement

- ☆ When the display range is exceeded (E.u), press the Down button ⑦ to change the shutter speed to the low-speed side, or raise the quantity of flash light and measure again to display a measurement value (aperture value).

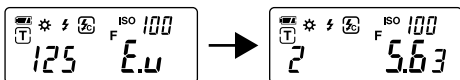

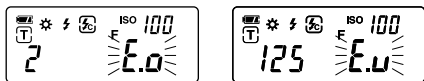

- ☆ When brightness (or darkness) exceeds the measuring range of the L-308S, E.o (or E.u) will blink to indicate that measuring is not possible. In such cases please adjust the quantity of flash light and measure again.



2-2 Auto Reset Cordless Flash mode

Generally this measuring mode is used when the synchro cord will not reach because of the distance between the flash and meter or when use of the synchro cord is inconvenient.

- 1) Press the Mode button ③ to select to the  auto reset cordless flash mode.
- 2) Press the Up button ⑥ or the Down button ⑦ to set the shutter speed. When setting shutter speed, first check the settings to confirm that they correspond to the settings available on the camera.
- 3) When the Measuring button ④ is pressed, the mode mark  will blink and the meter is ready to measure. The ready to measure mode will continue for approximately 90 seconds. During this time, trigger the flash to make a measurement.

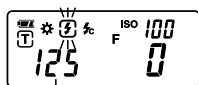
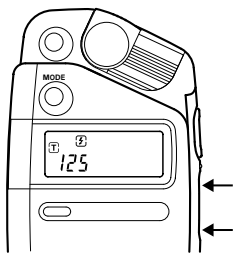

Set shutter speed

5. Measurement

- If the 90 second period is exceeded and the blinking mark stops, press the Measuring button again to return to ready to measure.
- When the light from the flash is received, the measured value (f stop) is displayed. Even after measurement, the mode mark  continues to blink and the meter is in ready state and a new measurement can be made. (Auto-reset function)

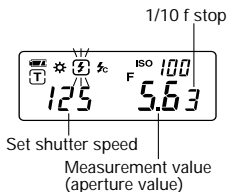

NOTE:

- When firing a flash, if the flash brightness is low compared to the ambient light, the meter may fail to detect the light. In this case, make measurements using cord flash mode.
- Rapid start fluorescent lamps and special lighting are sometimes mistaken for flash, and accidentally measured. In this case, make measurements using the cord flash mode.
- If the light receiving section experiences a sudden change in light, even when the flash has not been triggered during measurement standby, a measurement will be made in some cases. In such situations please use the cord flash mode.
- The luminous waveform of a flash bulb is gentle, so light will not be sensed in auto reset cordless flash mode. Always use the cord flash mode for measuring flash bulb light.

REFERENCE:

- Setting the shutter speed is similar to the previous instruction of item 2-1 Cord Flash mode (see page 14).
- A converted value is displayed when the ISO film speed is changed after taking the measurement.
- Readings outside the display range or beyond the measuring range are similar to the previous instruction 2-1 Cord Flash mode (see page 14).

6. Advanced Functions

1. Measuring Light Contrast

This method is used to check studio lighting or lighting unevenness.

- 1) Mount the Lumidisc accessory (see page 8).
- 2) Turn ON just the main light source.
Point the Lumidisc at the main light source from the subject position and then measure.
- 3) Next turn ON just the secondary light source.
In this state now point the Lumidisc at the secondary light source and measure.
- 4) Determine the luminance ratio (contrast ratio) using the difference of measuring values of the main light source and the secondary light source.

EV Difference of Measuring Value	Contrast Ratio
1	2 : 1
1.5	3 : 1
2	4 : 1
3	8 : 1
4	16 : 1
5	32 : 1

REFERENCE:

- To determine exposure in incident light, turn ON both main light source and secondary light source, point the Lumisphere at the camera lens axis and then measure.

6. Advanced Functions

2. How to use an incident illuminance (LUX or FC) meter

- 1) Mount the Lumidisc accessory (see page 8).
- 2) Set EV mode and ISO 100.
- 3) Measure with the area to be measured parallel to the Lumidisc.
- 4) Determine the illuminance (lux) from the calculation table using the measured EV.

☆ EV value → Lux conversion table

EV	Lux	EV	Lux	EV	Lux	EV	Lux
0.0	2.5	5.0	80	10.0	2600	15.0	82000
0.5	3.5	5.5	110	10.5	3600	15.5	120000
1.0	5.0	6.0	160	11.0	5100	16.0	160000
1.5	7.1	6.5	230	11.5	7200	16.5	230000
2.0	10	7.0	320	12.0	10000	17.0	330000
2.5	14	7.5	450	12.5	14000	17.5	460000
3.0	20	8.0	640	13.0	20000	18.0	660000
3.5	28	8.5	910	13.5	29000	18.5	930000
4.0	40	9.0	1300	14.0	41000	19.0	1300000
4.5	57	9.5	1800	14.5	58000	19.5	1900000

☆ EV value → Foot candle (FC) conversion table

EV	FC	EV	FC	EV	FC	EV	FC
0.0	0.23	5.0	7.4	10.0	240	15.0	7600
0.5	0.33	5.5	11	10.5	340	15.5	11000
1.0	0.46	6.0	15	11.0	480	16.0	15000
1.5	0.66	6.5	21	11.5	670	16.5	22000
2.0	0.93	7.0	30	12.0	950	17.0	30000
2.5	1.3	7.5	42	12.5	1300	17.5	43000
3.0	1.9	8.0	59	13.0	1900	18.0	61000
3.5	2.6	8.5	84	13.5	2700	18.5	86000
4.0	3.7	9.0	120	14.0	3800	19.0	120000
4.5	5.3	9.5	170	14.5	5400	19.5	170000

3. Custom setting function

To match your camera, you can set the setting value and display value to full, 1/2 or 1/3 stop.

- 1) To enter custom setting mode, hold down the Mode button (3) and turn ON the power button (1).
- 2) Once custom setting mode is entered, the 'CS' for custom setting will be displayed in the ISO display area, and the setting number will be displayed in the aperture value display area.
- 3) The setting number will change every time the Mode button (3) is pressed.

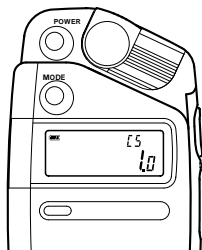

Setting number

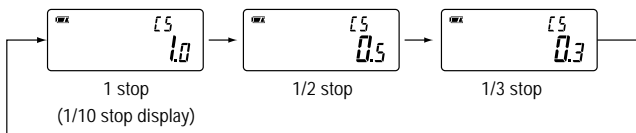

- 4) After completing the custom setting, turn OFF the power button to close the custom setting mode. The power will be automatically turned OFF with this operation.

NOTE:

- The 1/10 stop measurement value displayed when 1 stop is set will not be displayed when 1/2 stop or 1/3 stop is set.
- When using EV mode the 1/10 stop measurement value will be displayed whatever the stop is set.

7. Accessories

- **Synchro cord (Sold Separately)**

This is a five-meter long cord with three plugs. An exposure meter, a camera, and a flash can all be connected at the same time. This is convenient when measurements are made, because it is not necessary to plug and unplug the synchro cord.

Also one side of synchro cord has a lock feature to make sure connection with the meter.

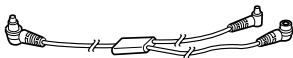

- **18% Gray Card (Sold Separately)**

18% gray card with cover (110 x 102mm, 4 1/4" x 3 1/3"), folds to 2 3/4" x 4 3/4", and fits in a shirt pocket.

This is used for measuring high (white) or low (black) reflected ratio subjects not to receive the effect by regarding them 18% of reflected ratio.

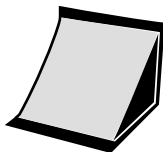

8. Technical Data

Type	• Digital exposure meter for ambient and flash light
Light receiving method	• Incident light and reflected light
Light receiving section	• Incident light: Lumisphere, Lumidisc • Reflected light: Lens (light receiving angle of 40°)
Light receptor	• Silicon photo diode
Measuring modes	• Ambient light: Shutter priority metering EV metering • Flash light: With synchro cord Without synchro cord
Measuring range (ISO 100)	• Ambient light: EV0 to EV19.9 • Flash: F1.4 to F90.9
Repeat accuracy	• ± 0.1 EV or less
Calibration constant	• Incident light metering: C = 340 (Lumisphere), C = 250 (Lumidisc) • Reflected light metering: K = 12.5
Display range	• Film speed: ISO 3 to 8000 (1/3 step) • Shutter speed Ambient light: 60 sec to 1/8000 sec (in 1, 1/2 or 1/3 step) Cine speed (f/s): 8, 12, 16, 18, 24, 25, 30, 32, 64, 128 (shutter angle: 180 degrees) Flash: 1 sec to 1/500 sec (in 1, 1/2 or 1/3 steps) and 1/75, 1/80, 1/90, 1/100 sec
	• Aperture value: F0.5 to F90.9 (in 1, 1/2 or 1/3 steps) • EV (exposure value): EV - 5 to EV26.2 (in 1/10 step)
Other functions	• Out-of-range indication: E.u (underexposure) and E.o (overexposure) warnings • Battery check indication with 3 level status icon • Auto power OFF (approx 4 min after last operation) • Custom setting
Battery used	• Type-AA 1.5-volt battery (alkaline, manganese or lithium)
Operating temperature range	• 0°C to +40°C
Storage temperature range	• -20°C to +60°C
Dimensions	• Approx 63W x 110H x 22D mm
Weight	• Approx 95g (battery included)
Standard accessories	• Soft case, strap, Lumidisc, soft case for Lumidisc, synchro terminal cap, type-AA 1.5-volt battery

Features and specifications are subject to change without notice.

9. Safty Guide and Maintenance

- NOTE:**
- To avoid damage to meter, never drop or subject it to shock.
 - Avoid storing meter in places with high temperature and/or humidity.
 - Be careful excessive temperature changes that could cause humidity and internal condensation, resulting in malfunction.
 - If the temperature of the meter drops to -10°C or beyond, response of the LCD becomes extremely slow and displays are difficult to read. At temperatures between 0 and 10°C the LCD will become somewhat slower than normal but this does not hinder usage. Also, when the temperature exceeds 50°C , the LCD will turn black and will be hard to read. This will return to normal when the temperature returns to normal.
 - Do not place the meter in direct sunlight during midsummer or near heaters, etc., as the temperature of the meter will rise beyond that of the air temperature. Be careful when using the meter in hot locations.
 - Remove battery if meter is not used for an extended period. Batteries can leak and damage the exposure meter. Dispose of used batteries properly.

Maintenance Notes

- Keep the Lumisphere, lens and Lumidisc clean and free from dust, foreign particles and scratches to keep accurarate measurement.
- Wipe the L-308S with a dry soft cloth if it becomes dirty.
Never use organic cleaners (like thinner or benzene) to clean Lumisphere.

SEKONIC CORPORATION

7-24-14, OIZUMI-GAKUEN-CHO, NERIMA-KU, TOKYO 178-8686, JAPAN

TEL: +81(0)3-3978-2335 FAX: +81(0)3-3978-5229

<http://www.sekonic.co.jp/English>

株式会社 エコニクス

〒 178-8686

東京都練馬区大泉学園町 7-24-14

TEL 03-3978-2366 FAX 03-3922-2144

<http://www.sekonic.co.jp>