

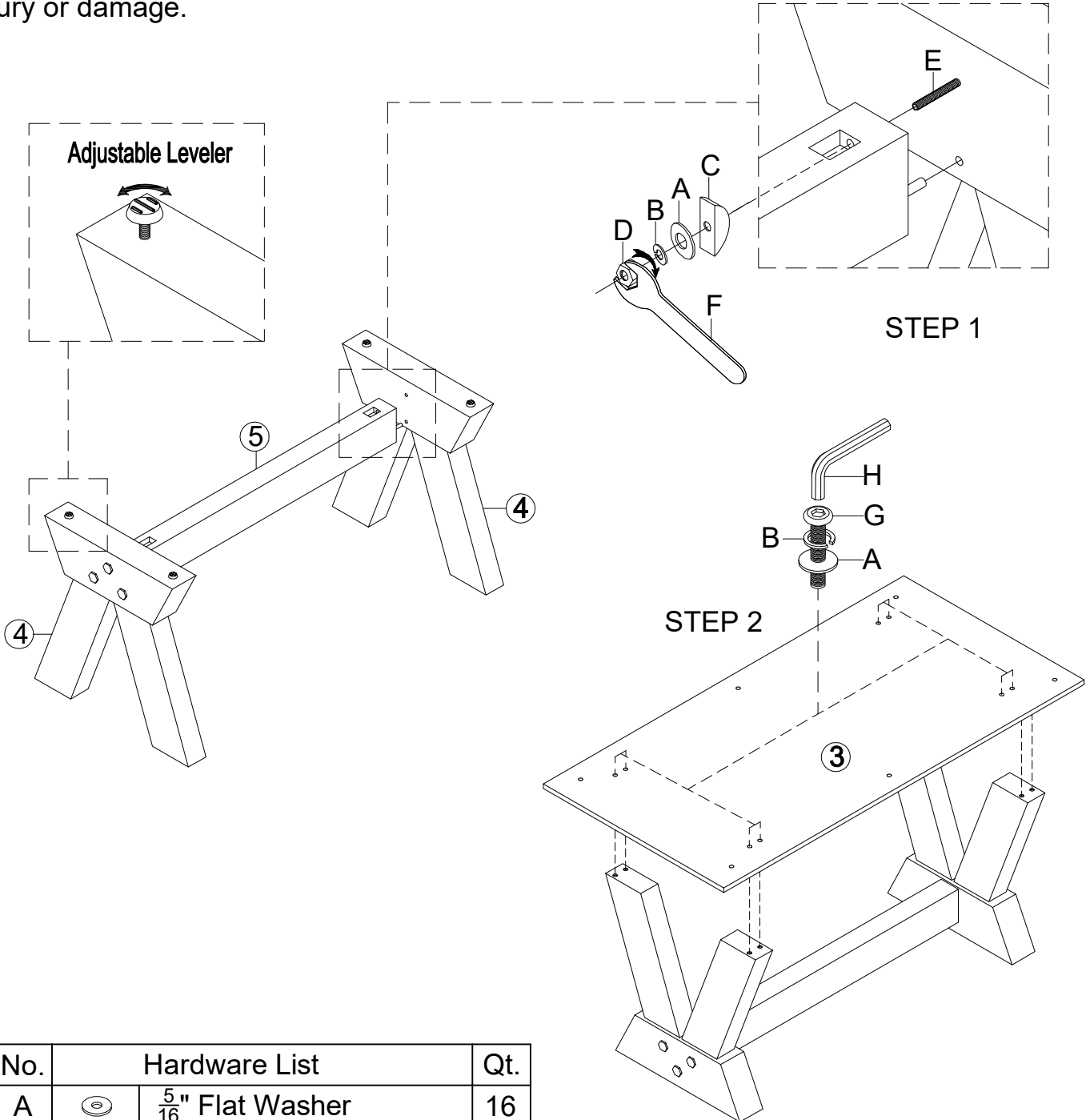













Thank you for purchasing this quality product from A.R.T. Furniture. Be sure to check all packing material for parts which may have come loose inside the carton during shipment. Identify and count all parts and compare with the parts list below.

Note: Some furniture is heavy, it is recommended that two people assembly this item to avoid injury or damage.



No.	Hardware List		Qt.
A		$\frac{5}{16}$ " Flat Washer	16
B		$\frac{5}{16}$ " Lock Washer	16
C		$\frac{5}{16}$ " Flat Washer	2
D		$\frac{5}{16}$ " Nut	2
E		$\frac{5}{16}$ " X $3\frac{1}{2}$ " Threaded Rod	2
F		$\frac{1}{2}$ " Wrench	1
G		$\frac{5}{16}$ " X $1\frac{1}{2}$ " Bolt	14
H		5mm Allen Wrench	1

Parts List			
1		Top Table	1
2		Table Leaf	2
3		Bridge Plate	1
4		Trestle End	2
5		Stretcher	1

