

HIKVISION®



ECI-D12F2 • ECI-D12F4 • ECI-D12F6
Network Dome Camera

Quick Start Guide

Manual Illustrations and Features

Graphics (screen shots, product pictures, etc.) in this document are for illustrative purposes only. Your actual product may differ in appearance. Your product might not support all features discussed in this document.

Hikvision USA Inc., 18639 Railroad St., City of Industry, CA 91748, USA • Hikvision Canada, 4848 rue Levy, Saint Laurent, Quebec, Canada, H4R 2P1

Telephone: +1-909-895-0400 • Toll Free in USA: +1-866-200-6690 • E-Mail: sales.usa@hikvision.com • www.hikvision.com

COPYRIGHT © 2017-2018 Hangzhou Hikvision Digital Technology Co., Ltd.

ALL RIGHTS RESERVED.

Any and all information, including, among others, wordings, pictures, graphs are the properties of Hangzhou Hikvision Digital Technology Co., Ltd. or its subsidiaries (hereinafter referred to be “Hikvision”). This user manual (hereinafter referred to be “the Manual”) cannot be reproduced, changed, translated, or distributed, partially or wholly, by any means, without the prior written permission of Hikvision. Unless otherwise stipulated, Hikvision does not make any warranties, guarantees or representations, express or implied, regarding to the Manual.

About this Manual

The Manual includes instructions for using and managing the product. Pictures, charts, images and all other information hereinafter are for description and explanation only. The information contained in the Manual is subject to change, without notice, due to firmware updates or other reasons. Please find the latest version in the company Web site (<http://overseas.hikvision.com/en/>).

Please use this user manual under the guidance of professionals.

Trademarks Acknowledgement

HIKVISION and other Hikvision trademarks and logos are the properties of Hikvision in various jurisdictions. Other trademarks and logos mentioned below are the properties of their respective owners.

Legal Disclaimer

TO THE MAXIMUM EXTENT PERMITTED BY APPLICABLE LAW, THE PRODUCT DESCRIBED, WITH ITS HARDWARE, SOFTWARE AND FIRMWARE, IS PROVIDED “AS IS,” WITH ALL FAULTS AND ERRORS, AND HIKVISION MAKES NO WARRANTIES, EXPRESS OR IMPLIED, INCLUDING WITHOUT LIMITATION, MERCHANTABILITY, SATISFACTORY QUALITY, FITNESS FOR A PARTICULAR PURPOSE, AND NON-INFRINGEMENT OF THIRD PARTY. IN NO EVENT WILL HIKVISION, ITS DIRECTORS, OFFICERS, EMPLOYEES, OR AGENTS BE LIABLE TO YOU FOR ANY SPECIAL, CONSEQUENTIAL, INCIDENTAL, OR INDIRECT DAMAGES, INCLUDING, AMONG OTHERS, DAMAGES FOR LOSS OF BUSINESS PROFITS, BUSINESS INTERRUPTION, OR LOSS OF DATA OR DOCUMENTATION, IN CONNECTION WITH THE USE OF THIS PRODUCT, EVEN IF HIKVISION HAS BEEN ADVISED OF THE POSSIBILITY OF SUCH DAMAGES.

REGARDING TO THE PRODUCT WITH INTERNET ACCESS, THE USE OF PRODUCT SHALL BE WHOLLY AT YOUR OWN RISKS. HIKVISION SHALL NOT TAKE ANY RESPONSIBILITIES FOR ABNORMAL OPERATION, PRIVACY LEAKAGE OR OTHER DAMAGES RESULTING FROM CYBER

ATTACK, HACKER ATTACK, VIRUS INSPECTION, OR OTHER INTERNET SECURITY RISKS; HOWEVER, HIKVISION WILL PROVIDE TIMELY TECHNICAL SUPPORT IF REQUIRED.

SURVEILLANCE LAWS VARY BY JURISDICTION. PLEASE CHECK ALL RELEVANT LAWS IN YOUR JURISDICTION BEFORE USING THIS PRODUCT IN ORDER TO ENSURE THAT YOUR USE CONFORMS THE APPLICABLE LAW. HIKVISION SHALL NOT BE LIABLE IN THE EVENT THAT THIS PRODUCT IS USED WITH ILLEGITIMATE PURPOSES.

IN THE EVENT OF ANY CONFLICTS BETWEEN THIS MANUAL AND THE APPLICABLE LAW, THE LATER PREVAILS.

Regulatory Information

FCC Information

Please take attention that changes or modification not expressly approved by the party responsible for compliance could void the user’s authority to operate the equipment.

FCC Compliance: This equipment has been tested and found to comply with the limits for a Class B digital device, pursuant to part 15 of the FCC Rules. These limits are designed to provide reasonable protection against harmful interference in a residential installation. This equipment generates, uses, and can radiate radio frequency energy and, if not installed and used in accordance with the instructions, may cause harmful interference to radio communications. However, there is no guarantee that interference will not occur in a particular installation. If this equipment does cause harmful interference to radio or television reception, which can be determined by turning the equipment off and on, the user is encouraged to try to correct the interference by one or more of the following measures:

- Reorient or relocate the receiving antenna.
- Increase the separation between the equipment and receiver.
- Connect the equipment into an outlet on a circuit different from that to which the receiver is connected.
- Consult the dealer or an experienced radio/TV technician for help

FCC Conditions

This device complies with part 15 of the FCC Rules. Operation is subject to the following two conditions:

1. This device may not cause harmful interference.
2. This device must accept any interference received, including interference that may cause undesired operation.

EU Conformity Statement



This product and, if applicable, the supplied accessories too are marked with “CE” and comply therefore with the applicable harmonized European standards listed under the EMC Directive 2014/30/EU, the RoHS Directive 2011/65/EU.



2012/19/EU (WEEE Directive): Products marked with this symbol cannot be disposed of as unsorted municipal waste in the European Union. For proper recycling, return this product to your local supplier upon the purchase of equivalent new equipment, or dispose of it at designated collection points. For

more information see: www.recyclethis.info



2006/66/EC (Battery Directive): This product contains a battery that cannot be disposed of as unsorted municipal waste in the European Union. See the product documentation for specific battery information. The battery is marked with this symbol, which may include lettering to indicate cadmium (Cd), lead (Pb), or mercury (Hg). For proper recycling, return the battery to your supplier

or to a designated collection point. For more information see: www.recyclethis.info

Industry Canada ICES-003 Compliance

This device meets the CAN ICES-3 (B)/NMB-3(B) standards requirements.



Safety Instruction

These instructions are intended to ensure that user can use the product correctly to avoid danger or property loss.

The precaution measure is divided into “Warnings” and “Cautions”

Warnings: Serious injury or death may occur if any of the warnings are neglected.

Cautions: Injury or equipment damage may occur if any of the cautions are neglected.

	
Warnings Follow these safeguards to prevent serious injury or death.	Cautions Follow these precautions to prevent potential injury or material damage.



Warnings

- Proper configuration of all passwords and other security settings is the responsibility of the installer and/or end-user.
- In the use of the product, you must be in strict compliance with the electrical safety regulations of the nation and region. Please refer to technical specifications for detailed information.
- Input voltage should meet both the SELV (Safety Extra Low Voltage) and the Limited Power Source with 12 VDC according to the IEC60950-1 standard. Please refer to technical specifications for detailed information.
- Do not connect several devices to one power adapter as adapter overload may cause over-heating or a fire hazard.
- Please make sure that the plug is firmly connected to the power socket. When the product is mounted on wall or ceiling, the device shall be firmly fixed.
- If smoke, odor or noise rise from the device, turn off the power at once and unplug the power cable, and then please contact the service center.



Cautions

- Make sure the power supply voltage is correct before using the camera.
- Do not drop the camera or subject it to physical shock.
- Do not touch sensor modules with fingers. If cleaning is necessary, use clean cloth with a bit of ethanol and wipe it gently. If the camera will not be used for an extended period, please replace the lens cap to protect the sensor from dirt.
- Do not aim the camera at the sun or extra bright locations. Blooming or smearing may occur (which is not a malfunction), and affect the sensor endurance at the same time.
- The sensor may be burned out by a laser beam, so when any laser equipment is in using, make sure that the surface of sensor will not be exposed to the laser beam.
- Do not place the camera in extremely hot, cold (the operating temperature shall be -30° to +60° C, or -40° to +60° C if the camera model has an “H” in its suffix), dusty or damp locations, and do not expose it to high electromagnetic radiation.
- To avoid heat accumulation, good ventilation is required for the operating environment.
- Keep the camera away from liquid while in use.
- While in delivery, the camera shall be packed in its original packing or packing of the same texture.
- Regular part replacement: a few parts (e.g., electrolytic capacitor) of the equipment shall be replaced regularly according to their average enduring time. The average time varies because of differences between operating environment and using history, so regular checking is recommended for all the users. Please contact with your dealer for more details.
- Improper use or replacement of the battery may result in hazard of explosion. Replace with the same or equivalent type only. Dispose of used batteries according to the instructions provided by the battery manufacturer.
- If the product does not work properly, please contact your dealer or the nearest service center. Never attempt to disassemble the camera yourself. (We shall not assume any responsibility for problems caused by unauthorized repair or maintenance.)

Contents

1 Appearance	6
2 Installation	6
3 Network Camera LAN Configuration	9
3.1 Wiring	9
3.2 Activate the Camera	10
3.2.1 Activation via Web Browser	10
3.2.2 Activation via SADP Software	11
3.3 Modify the IP Address	12
4 Access via Web Browser	13
5 Hik-Connect	14
5.1 Enable Hik-Connect for Use with Cameras	14
5.2 Enable Hik-Connect Service via SADP Software	14
5.2.1 Enable Hik-Connect via a Web Browser	15
5.3 Add Camera to Hik-Connect	15
5.4 Initialize the Memory Card	16

1 Appearance

The appearance of this network dome camera is shown in figure 1-1.

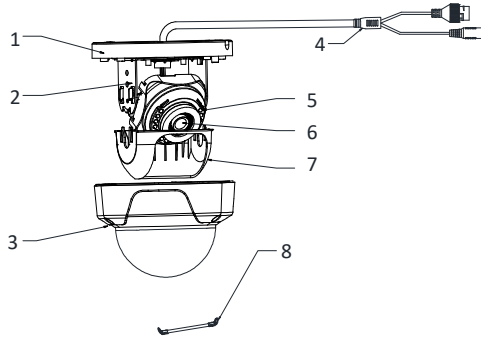

Figure 1-1 Camera Overview

Table 1-1 Description of Camera

No.	Description
1	Mounting Base
2	Pan Adjusting Mount
3	Bubble
4	Network and Power Interface
5	IR LED
6	Lens
7	Black Liner
8	Safety Rope

Notes:

- Power on the camera while pressing the RESET button, and press button for another 10 seconds to restore the default settings, including the user name, password, IP address, port number, etc.
- For cameras that support Power over Ethernet (PoE), the power is passed along with data via Ethernet cabling. A switch that supports PoE function is required.

2 Installation

Before You Start:

- Make sure that the device in the package is in good condition and all the assembly parts are included.

- The standard power supply is 12 VDC. Make sure your power supply matches that of your camera.
- Make sure that all of the related equipment is powered off during installation.
- Check product specifications for the installation environment.
- Make sure that the wall is strong enough to withstand four times the weight of the camera and the bracket.

For cameras that support IR, you are required to take the following precautions in order to prevent IR reflection:

- Dust or grease on the dome cover will cause IR reflection. Do not remove the dome cover film until installation is finished. If there is dust or grease on the dome cover, clean it with a soft cloth and isopropyl alcohol.
- Make sure that there is no reflective surface too close to the camera lens. The IR light from the camera may reflect back into the lens to cause reflection.
- The foam ring around the lens must be seated flush against the inner surface of the bubble so as to isolate the lens from the IR LEDs. Fasten the dome cover to the camera body so that the foam ring and dome cover attach seamlessly.

Steps:

1. Attach the drill template to the ceiling.
2. Drill the screw holes and cable hole (optional) into the ceiling according to the drill template.

Note:

A cable hole is required when you use a ceiling outlet to route the cables.

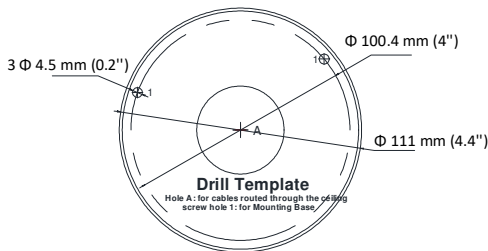

Figure 2-1 Drill Template

3. Loosen the screws with a hex wrench (supplied) to remove the bubble.

Note:

The three screws do not need to be completely unscrewed.

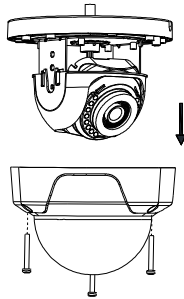

Figure 2-2 Remove the Bubble

4. Fix the mounting base onto the ceiling with the supplied screws.

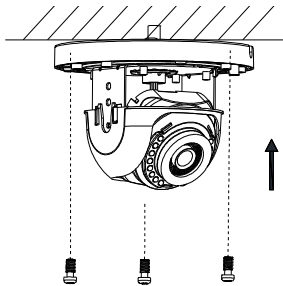

Figure 2-3 Fix the Mounting Base

5. Route the cables through the cable hole.

Note:

If required, you can route cables through the side opening on the side of the mounting base.

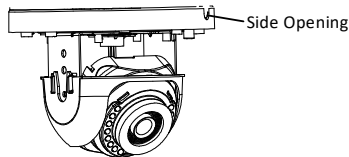

Figure 2-4 Side Opening

6. Connect the corresponding cables, such as the power and network cables.
7. Power on the camera, and set the network configuration (for details, refer to [3 Network Camera LAN Configuration](#) and [4 Access via Web Browser](#)) to check whether the image is obtained at the right angle. If not, adjust the surveillance angle.

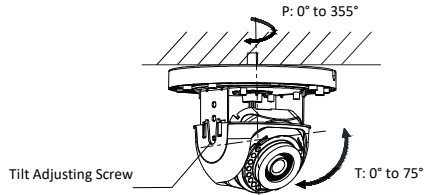

Figure 2-5 Type I Camera 2-Axis Adjustment

- 1) Loosen the tilt adjusting screw to adjust the tilt angle [0° to 75°].
 - 2) Hold the black liner to adjust the pan angle [0° to 355°].
8. Reinstall the bubble and tighten the screws.

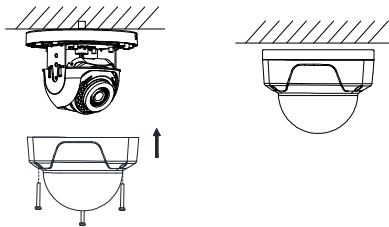

Figure 2-6 Bubble Reinstallation

3 Network Camera LAN Configuration

Note:

The use of products with internet access carries inherent security risks. In order to avoid network attacks and information leakage, strengthen your own network protection. If the product does not work properly, contact your dealer or the nearest service center.

3.1 Wiring

Connect the camera to the network as follows:

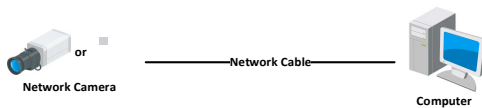

Figure 3-1 Connect Directly

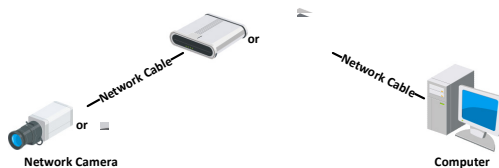

Figure 3-2 Connect via a Switch or a Router

3.2 Activate the Camera

Activate the camera by setting a strong password. Activation via Web browser, activation via SADP, and activation via client software are supported. Activation via SADP software and Web browser will be used as examples to introduce camera activation.

Note:

Refer to the Network Camera User Manual for activation via client software.

3.2.1 Activation via Web Browser

Steps:

1. Power the camera on. Connect the camera to your computer or the switch/router that your computer connects to.
2. Input the IP address (default is 192.16.1.64) into the address bar of the Web browser, and press **Enter** to enter the activation interface.

Notes:

The computer and the camera should belong to the same subnet.

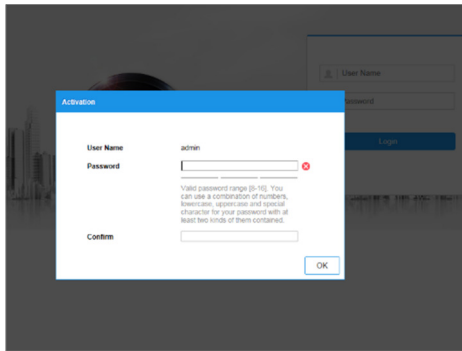

Figure 3-3 Activation Interface (Web)

3. Create and input a password.



STRONG PASSWORD RECOMMENDED – We highly recommend creating a strong password of your own choosing (using a minimum of eight characters, including upper case letters, lower case letters, numbers, and special characters) in order to increase the security of your product. We also recommend regularly resetting your password on a weekly or monthly basis, especially in high security systems.

4. Confirm the password.
5. Click **OK** to save the password and enter the live view interface.

3.2.2 Activation via SADP Software

SADP software is used for detecting online devices, activating cameras, and resetting passwords.

SADP can be obtained from the supplied disk or the official website, and installed by following the prompts.

Follow the steps to activate the camera.

Steps:

1. Run the SADP software to search the online devices.
2. Check the device status from the device list, and select the inactive device.

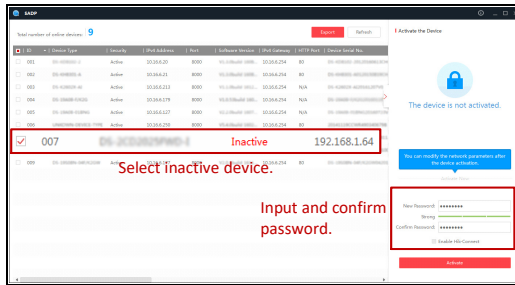

Figure 3-4 SADP Interface

Note:

SADP supports batch camera activations. Refer to the SADP user manual for further details.

3. Create, input, and confirm a password.

! STRONG PASSWORD RECOMMENDED – We highly recommend creating a strong password of your own choosing (using a minimum of eight characters, including upper case letters, lower case letters, numbers, and special characters) in order to increase the security of your product. We also recommend regularly resetting your password on a weekly or monthly basis, especially in high security systems.

Note:

You can enable the Hik-Connect service for the device during activation. Refer to Chapter 5.1 for detailed information.

4. Click **Activate** to start activation.

You can check whether activation is complete in the pop-up window. If activation fails, make sure that the password meets the requirements, and try again.

3.3 Modify the IP Address

Purpose:

To view and configure the camera via LAN (Local Area Network), connect the network camera to the same subnet as your PC.

Use the SADP software or client software to search and change the IP address of the device. IP Address modification via SADP software will be used as an example.

In order to modify the IP address via client software, refer to the user manual of the client software.

Steps:

1. Run SADP.
2. Select an active device.
3. Change the device IP address to the same subnet as your computer by either modifying the IP address manually, or by checking the **Enable DHCP** checkbox.



Figure 3-5 Modify the IP Address

Note:

Hik-Connect can be enabled during activation. Refer to Chapter 5.1 for detailed information.

SADP supports batch IP address modification. Refer to the SADP user manual for details.

1. Input the admin password and click **Modify** to complete IP address modification.

4 Access via Web Browser

System Requirement:

Operating System: Microsoft Windows XP SP1 and above

CPU: 2.0 GHz or greater

RAM: 1 GB or greater

Display: 1024 × 768 resolution or higher

Web Browser: Internet Explorer 8.0 or higher, Apple Safari 5.0.2 or higher, Mozilla Firefox 5.0 or higher, and Google Chrome 18 or higher

Steps:

1. Open the Web browser.
2. In the browser address bar, input the IP address of the network camera, and press the **Enter** key to enter the login interface.

Note:

The default IP address is 192.168.1.64. It is suggested that you change the IP address to the same subnet as your computer.

3. Input the user name and password.

The admin user should configure the device accounts and user/operator permissions properly. Delete any unnecessary accounts and user/operator permissions.

Note:

The device IP address locks if the admin user performs seven failed password attempts (five attempts for the user/operator).

4. Click **Login**.



Figure 4-1 Login Interface

5. Install the plug-in before viewing the live video and managing the camera. Follow the installation prompts to install the plug-in.

Note:

You may have to close the Web browser to complete plug-in installation.

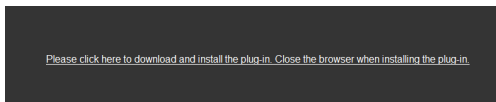

Figure 4-2 Download Plug-in

6. Reopen the Web browser after plug-in installation and repeat steps 2 to 4 in order to log in.

Note:

For further configuration instructions, refer to the network camera user manual.

5 Hik-Connect

Purpose:

Hik-Connect is a mobile application to view live camera images, receive alarm notifications, etc.

5.1 Enable Hik-Connect for Use with Cameras

Purpose:

Enable Hik-Connect should on your camera before using the service.

You can enable the service either via SADP software or a Web browser.

5.2 Enable Hik-Connect Service via SADP Software

Steps:

1. Check the **Enable Hik-Connect** checkbox:
 - 1). For the “Activate the Device” page that appears during camera activation, refer to Chapter 3.2.2.
 - 2). For the “Modify Network Parameters” page that appears while modifying the IP address, refer to Chapter 3.3.
2. Create or change the verification code.

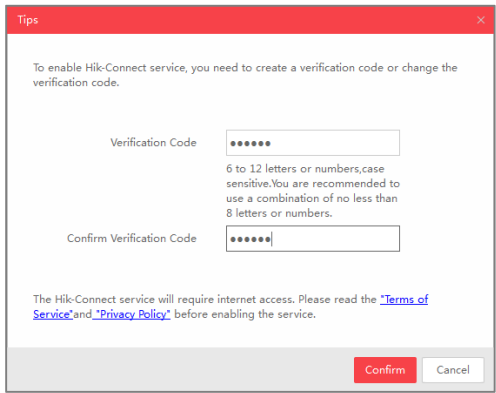

Figure 5-1 Verification Code Setting (SADP)

Note:

The verification code is required when adding the camera to Hik-Connect.

3. Click and read the “Terms of Service” and “Privacy Policy.”
4. Confirm the settings.

5.2.1 Enable Hik-Connect via a Web Browser

Before You Start:

Activate the camera before enabling the service. Refer to Chapter 3.2. for more information.

Steps:

1. Access the camera via the Web browser. Refer to Chapter 4.
2. Enter the platform access configuration interface, as follows: **Configuration > Network > Advanced Settings > Platform Access.**

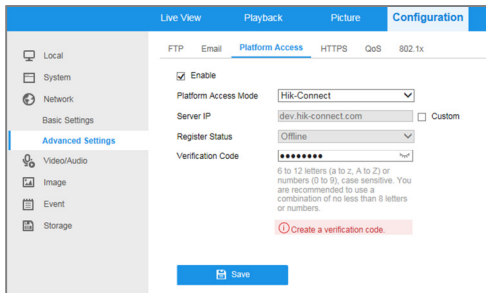

Figure 5-2 Platform Access Configuration (Web)

3. Set the **Platform Access Mode** to **Hik-Connect**.
4. Check the **Enable** checkbox.
5. Click and read the “Terms of Service” and “Privacy Policy” in the pop-up window.
6. Create or change the verification code for the camera.

Note:

A verification code is required when you add the camera to Hik-Connect.

7. Save the settings.

5.3 Add Camera to Hik-Connect

Before You Start:

You need to enable Hik-Connect on the camera before adding it to your Hik-Connect account. Refer to Chapter 5.1.

Steps:

1. Use a network cable to connect the camera to a router if the camera does not support Wi-Fi.



Figure 5-3 Connect a Router

Note:

After the camera connects to the network, wait one minute before using the camera with Hik-Connect.

2. Add the camera to the Hik-Connect app:

- **If Accessing the Camera through an NVR:** Tap “+” on the upper-right corner and scan the QR code that appears in the NVR interface.
- **If Accessing the Camera through a Web Browser:** Tap the  icon and type in the camera’s serial number.

3. Input your camera’s verification code.

Note:

The required verification code is created or changed when you enable Hik-Connect on your camera.

Forgotten verification codes can be recovered in the **Platform Access** configuration page via the web browser.

4. Follow prompts to set up the network connection and add the camera to your Hik-Connect account.

Note:

For detailed information, refer to the Hik-Connect user manual.

5.4 Initialize the Memory Card

Note:

The microSD memory card is not included with the camera and must be purchased separately.

Steps:

1. Check the status of the memory card by tapping on the Storage Status in the Device Settings interface.
2. If the memory card status displays as Uninitialized, tap to initialize it. The status will then change to Normal. You can then start recording any event-triggered video in the camera such as motion detection-generated videos.

