

PLEASE CONTACT US FIRST

TollFree: 1-800-935-3959 (Mon. Fri. 9:00AM to 5:00 PM EST)

✉ support@teamson.com

☎ 1-631-274-3353

Thank you for choosing Teamson produce. If you need help with assembly or if you are missing parts, hardware, we are here to help !



Versanora

Item No: VNF-00078

Item name: Versanora - Kingston Bookcase
-Faux Marble/Walnut











Warning

Small parts and sharp points may be present prior to assembly. Please follow the assembly instructions closely. Improper assembly can result in personal or property damage. 2 adults are required to safely assemble this product.

Care Instructions







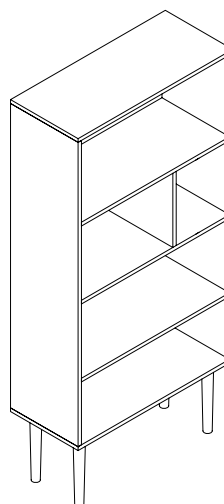

Dust often using a clean, soft, dry and lint-free cloth. • When blot spills, wipe with a clean, damp cloth immediately. We do not recommend the use of chemical cleansers, abrasives or furniture polish on our lacquered finish. Periodically check to make sure all connections are tight. Re-tighten if necessary.

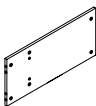
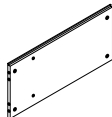
Hardware List:

A		18PCS
B		18PCS
C		24PCS
D		6PCS
E		16PCS
F		1PCS
G		18PCS
I		1PCS
J		1PCS
K		1PCS
L		1PCS



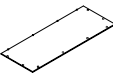
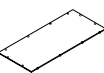



Part List:

1	2	3	4	5	6	7	8	9	10
									
1PC	1PC	1PC	1PC	1PC	1PCS	1PC	1PC	1PC	1PC
11									
									
4PCS									

MADE IN CHINA



www.teamson.com

STEP 1

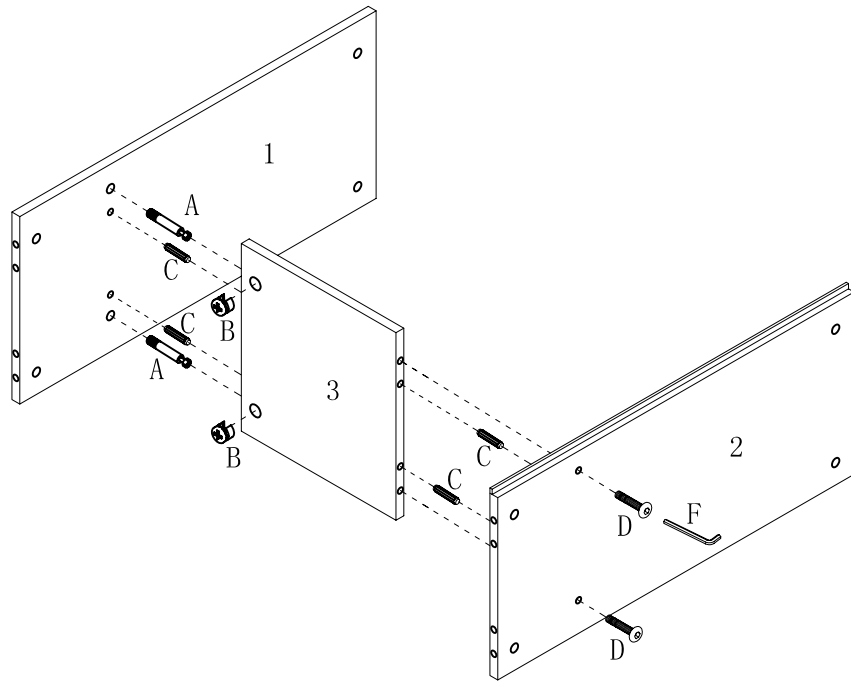
A:		2 PCS
B:		2 PCS
C:		4 PCS
D:		2 PCS
F:		1 PCS



STEP 2



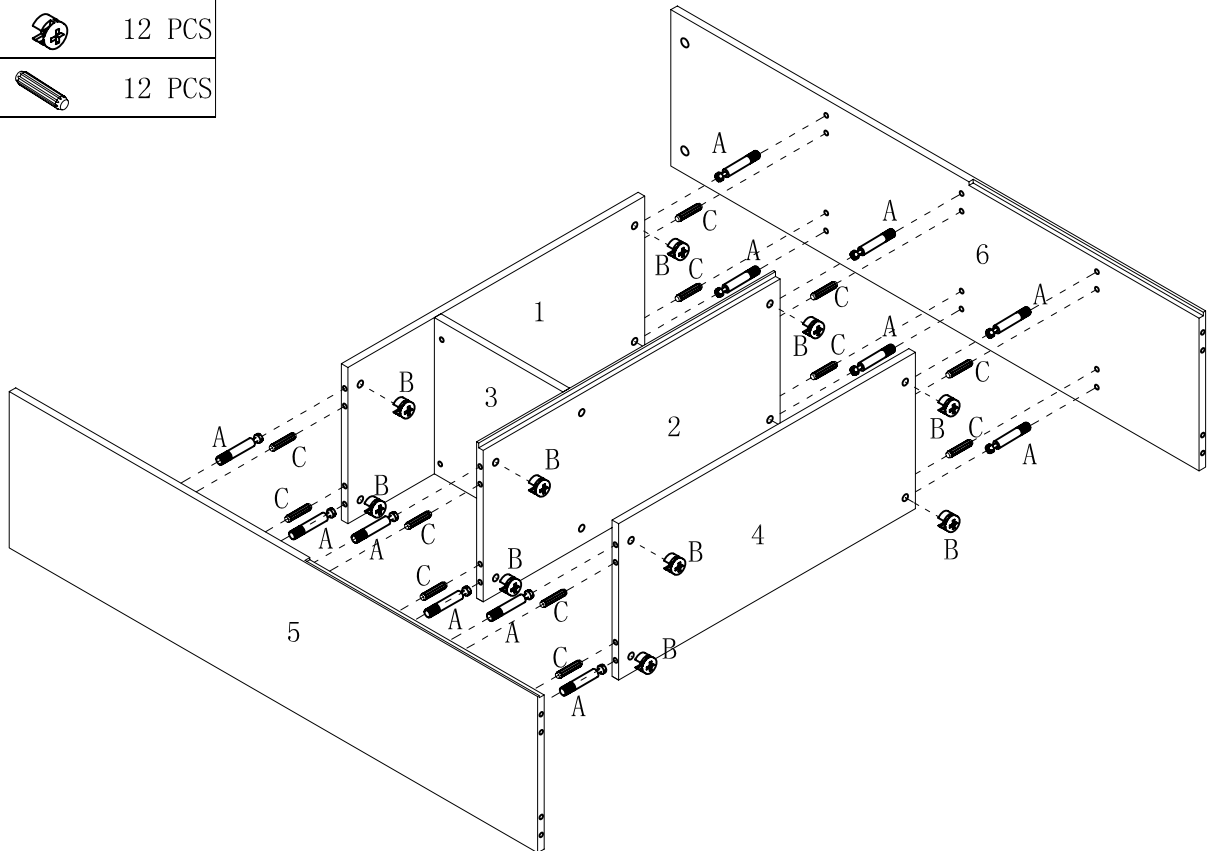

A:		12 PCS
B:		12 PCS
C:		12 PCS



MADE IN CHINA

www.teamson.com

STEP 3

A:		4 PCS
B:		4 PCS
C:		8 PCS
D:		4 PCS
F:		1 PCS

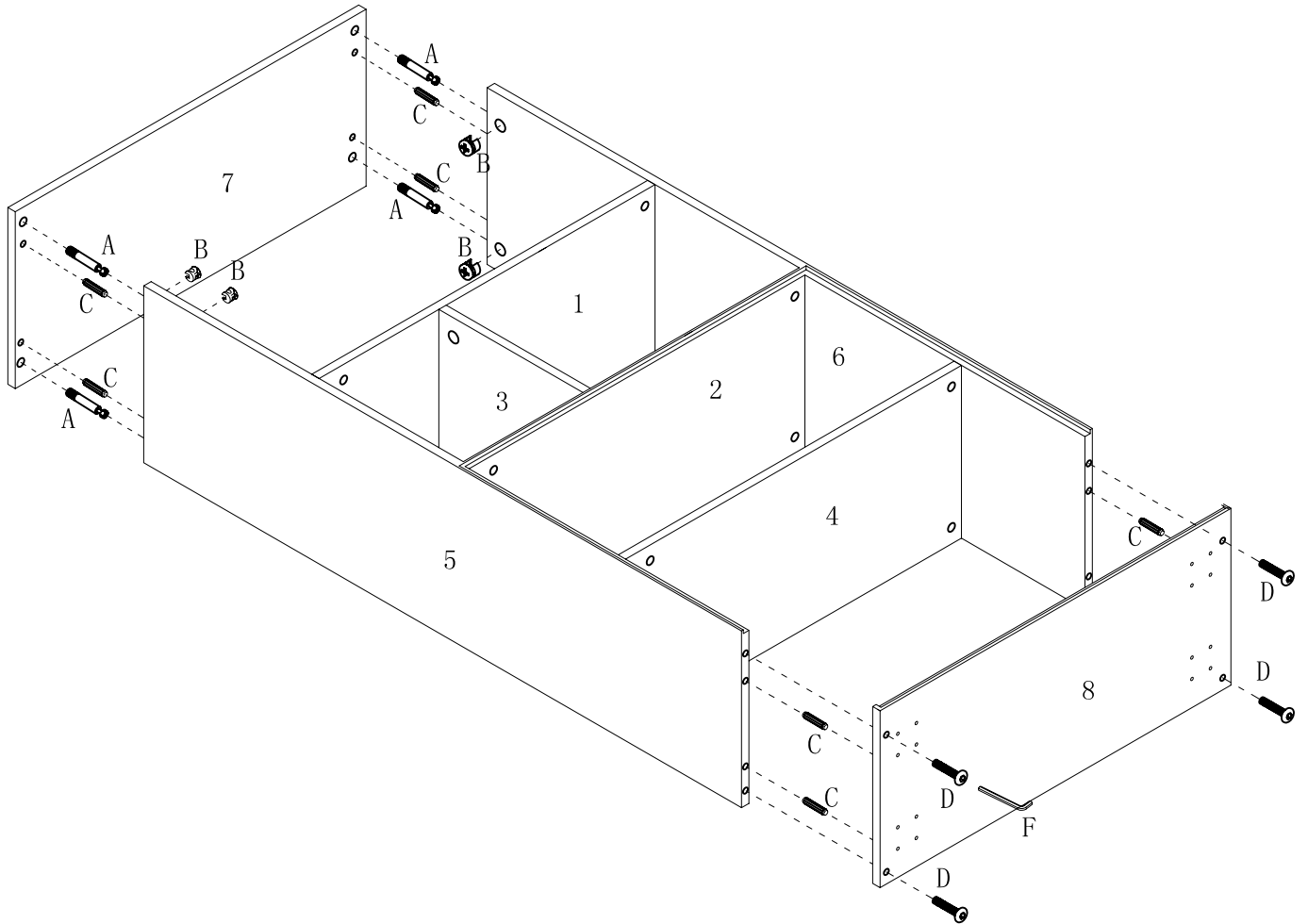

MADE IN CHINA

www.teamson.com

STEP 4

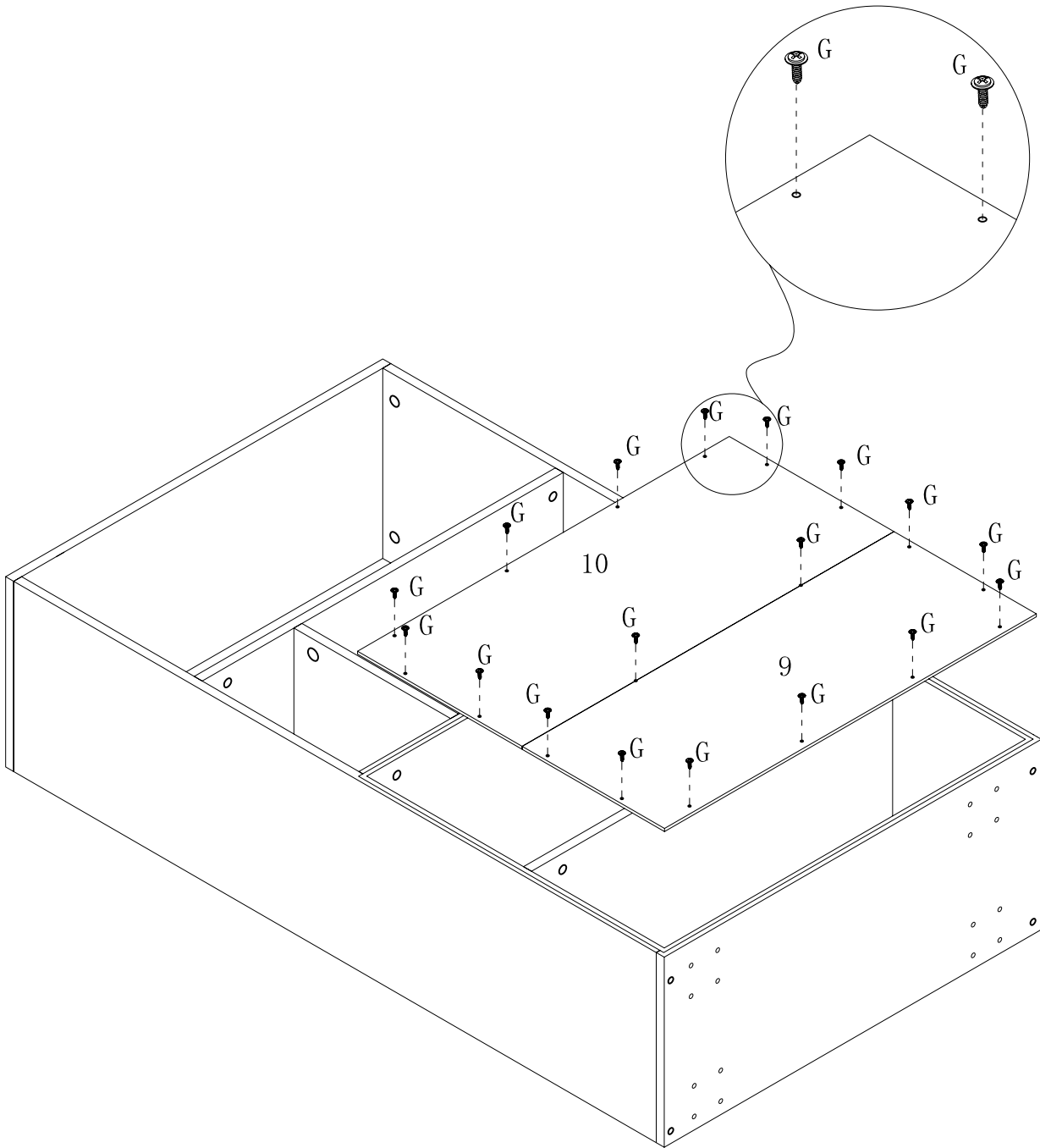

G:  18 PCS



MADE IN CHINA

www.teamson.com

STEP 5

E:		16 PCS
G:		1 PCS

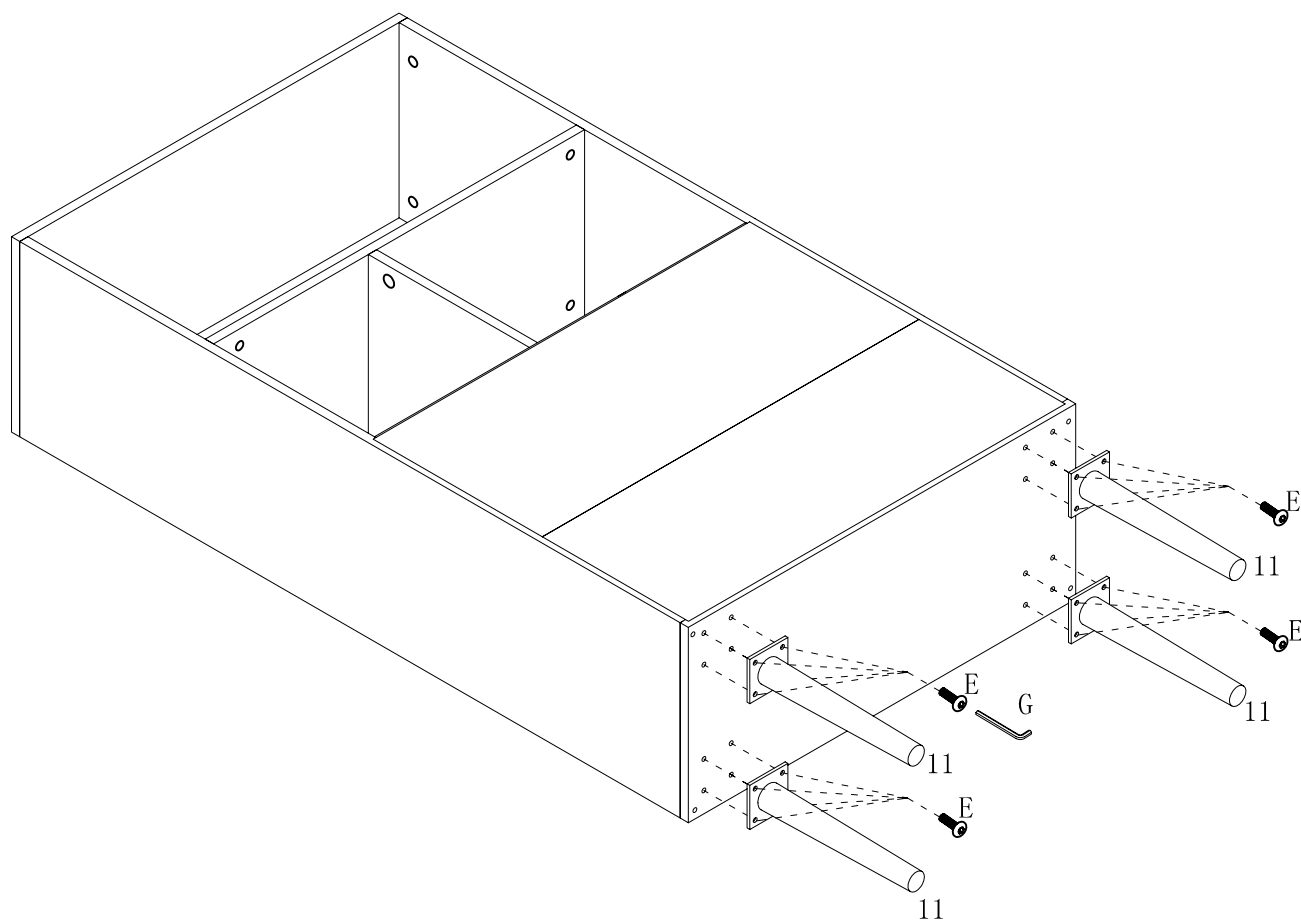





MADE IN CHINA

www.teamson.com

STEP 6

Anti -Tip hardware assemble

I:		1PCS
J:		1PCS
K:		1PCS
L:		1PCS

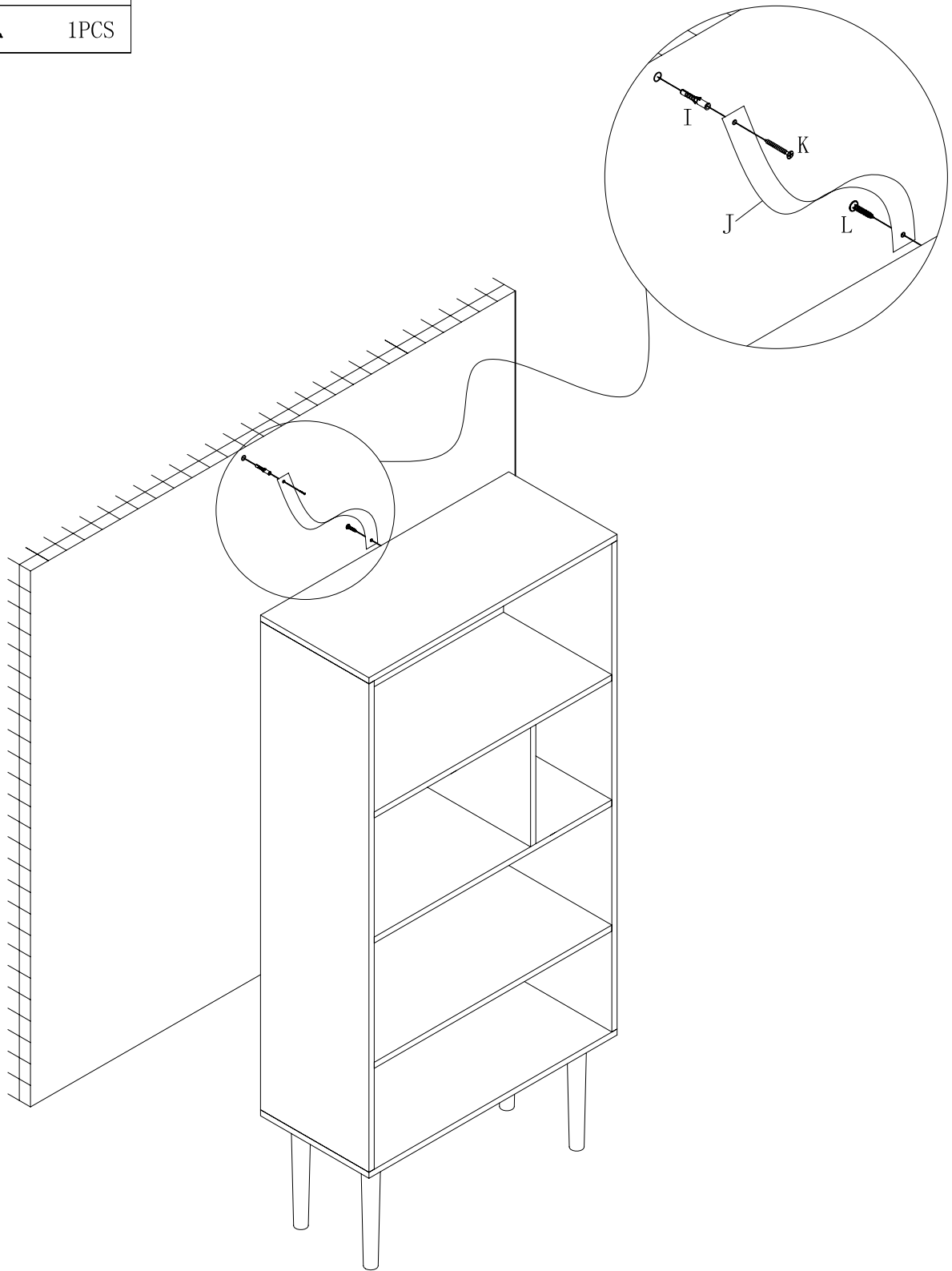

MADE IN CHINA

www.teamson.com