

A

x1 Chair cushion *
x1 Coussin de chaise
x1 Cojín de silla



B

x2 Front Leg *
x2 Patte avant
x2 Pata delantera

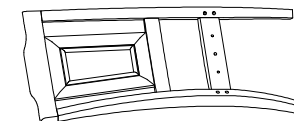

C

x1 Chair Back *
x1 Dossier de chaise
x1 Respaldo de la silla

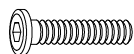

D

x2 Allen Bolt Ø1/4" x 40mm *
x2 Vis à tête creuse hexagonale
Ø1/4 " x 40mm
x2 Perno Allen Ø1/4 " x 40mm

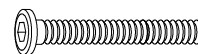

E

x4 Allen Bolt Ø1/4" x 76mm *
x4 Vis à tête creuse hexagonale
Ø1/4 " x 76mm
x4 Perno Allen Ø1/4 " x 76mm



F

x4 Allen Bolt Ø1/4" x 55mm *
x4 Vis à tête creuse hexagonale
Ø1/4 " x 55mm
x4 Perno Allen Ø1/4 " x 55mm



G

x10 Lock Washer Ø1/4" *
x10 Rondelle de blocage Ø1/4 "
x10 Arandela de seguridad Ø1/4"



H

x10 Flat Washer Ø1/4' x 19mm *
x10 Rondelle de plate Ø1/4 " x 19mm
x10 Arandela plana Ø1/4 " x 19mm

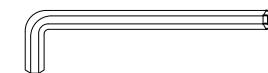

K

x1 Allen Key 4mm *
x1 Clé hexagonale 4mm
x1 Llave allen 4mm

* Replaceable Part

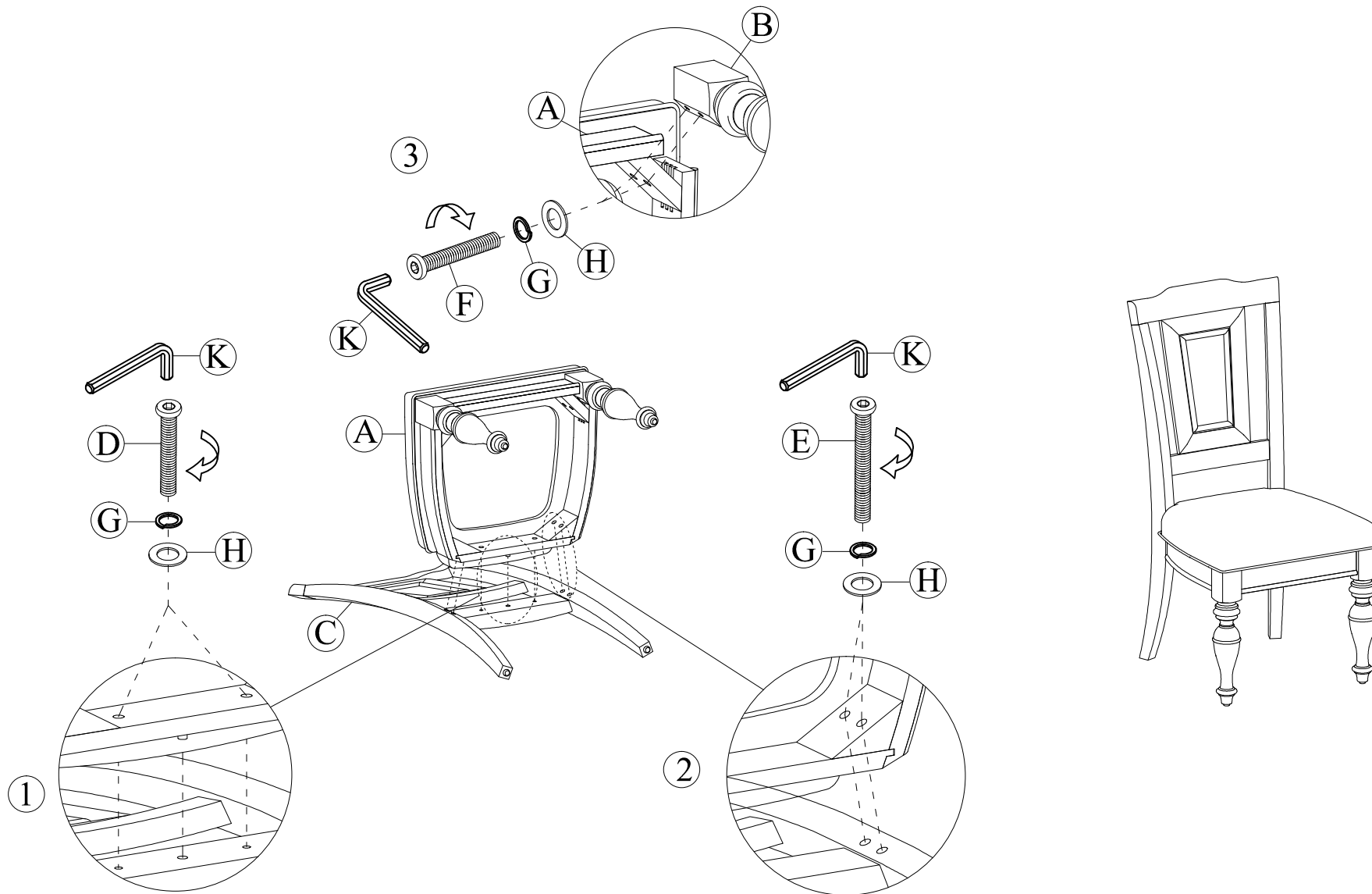

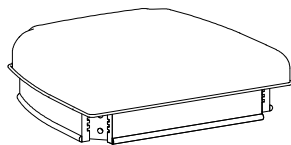

x1 RP351260-CUS
Chair Cushion *
Coussin de chaise
Cojín de silla



x2 RP351260-LEGF
Front Leg *
Patte avant
Pata delantera

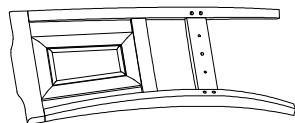

x1 RP351260-BACK
Chair Back *
Dossier de chaise
Respaldo de silla

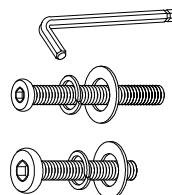

x1 RP351-260-HWKIT
Hardware Kit *
Kit de matériel
Kit de hardware



x4 RC-BR-NAIL
Brown Small Plastic Nail *
Clou en plastique
Clavo de plástico

* Replaceable Part