

# VACUUM PUMP & BLEEDER KIT

Item Number W87032

## OWNER'S MANUAL



Performance Tool®

**▲WARNING:** READ, UNDERSTAND AND FOLLOW ALL INSTRUCTIONS AND WARNINGS BEFORE OPERATING THIS TOOL. FAILURE TO DO SO MAY RESULT IN PERSONAL INJURY AND/OR PROPERTY DAMAGE AND WILL VOID WARRANTY.

**PT**<sup>®</sup>  
Performance Tool

## TOOL FEATURES

- 2 in. Pressure gauge for accurate measurements.
- Reservoir jar with operation and transport lids.
- Collection of popular adapters, connectors and plugs.

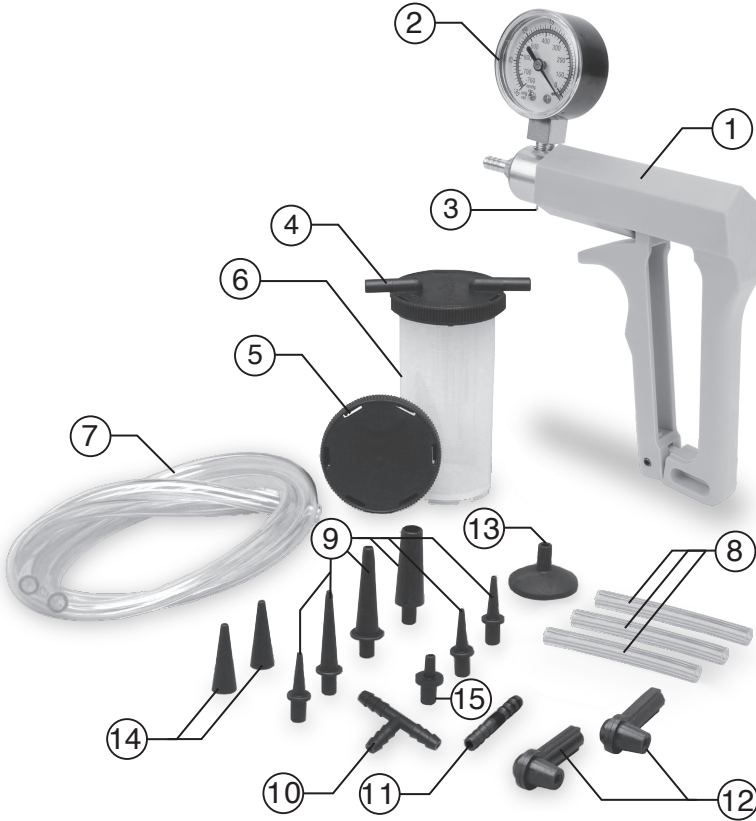

## EXPANDED PARTS LIST

No.	Description	Qty.	No.	Description	Qty.
1	Vacuum Pump.....	1	9	Tapered Hose Adapters.....	6
2	2 in. Pressure Gauge .....	1	10	"T" Hose Connector .....	1
3	Vacuum Release Control ....	1	11	Straight Hose Connector ...	1
4	Operation Jar Lid .....	1	12	Brake Bleeder Screw Adapter	2
5	Transport Jar Lid.....	1	13	Universal Cup Adapter.....	1
6	Reservoir Jar.....	2	14	Plug.....	2
7	24 in. x 1/4 in. I.D. Hose .....	2	15	Vacuum Hose Adapter.....	1
8	1/4 in. I.D. Vacuum Hoses...	3			

## SPECIFICATIONS:

Gauge.....	2 in. Diameter
Gauge Scale.....	0,- 25 in/Hg (0<->63.5 cm/Hg) Vacuum
Long Vacuum Hose .....	(2) 1/4 in. I.D. X 24 in.
Small Vacuum Hose .....	(3) 1/4 in. I.D.
Reservoir Jar. ....	4 oz.
Net Weight.....	1.8 lbs.

**Specifications are subject to change without notice.**

## SAFETY GUIDELINES / DEFINITIONS

*This instruction manual is intended for your benefit. Please read and follow the safety, installation, maintenance and troubleshooting steps described within to ensure your safety and satisfaction. The contents of this instruction manual are based upon the latest product information available at the time of publication. The manufacturer reserves the right to make product changes at any time without notice.*

**▲WARNING:** Read and understand this entire instruction manual before attempting to assemble, install, operate or maintain this product. Failure to comply with the instructions may result in serious personal injury and/or property damage!

**The following signal words are used to emphasize safety warnings that must be followed when using this product:**

**▲DANGER:** Indicates an imminently hazardous situation that, if not avoided, WILL result in death or serious injury.

**▲CAUTION:** Indicates a potentially hazardous situation that, if not avoided, MAY result in minor or moderate injury.

**▲WARNING:** Indicates a potentially hazardous situation that, if not avoided, COULD result in death or serious injury.

**▲NOTE:** Indicates important information, which if not followed, MAY cause damage to equipment.

## UNPACKING

- When unpacking, check to make sure all the parts shown on pg. 2 are included. If any parts are missing or broken, please call customer support at 1-800-497-0552

## GENERAL SAFETY

- Stay alert. Watch what you are doing, and use common sense when operating the Vacuum Pump. Do not use the tool while tired or under the influence of drugs, alcohol, or medication. A moment of inattention while operating the tool may result in serious personal injury.
- Dress properly. Do not wear loose clothing or jewelry. Contain long hair. Keep your hair, clothing, and jewelry away from moving parts. Loose clothes, jewelry, or long hair can be caught in moving parts.
- Do not overreach. Keep proper footing and balance at all times. Proper footing and balance enables better control of the power tool in unexpected situations.
- Use safety equipment. Always wear eye protection. Safety equipment such as dust masks, non-slip safety shoes, helmets or ear protection used in appropriate conditions will reduce the risk of injury.

## PRODUCT WARNINGS

- Maintain a safe working environment. Keep the work area well lit. Make sure there is adequate surrounding workspace. Always keep the work area free of obstructions, grease, oil, trash, and other debris. Do not use the Vacuum Pump in areas near flammable chemicals, dusts, and vapors. Do not use this product in a damp or wet location.
- Maintain labels and nameplates on this product. These carry important information. If unreadable or missing, contact Performance Tool for a replacement.
- Keep the handles of the Vacuum Pump dry, clean, and free from brake fluid, oil, and grease.
- Prior to using the Vacuum Pump make sure to read and understand all warnings, safety precautions, and instructions as outlined in the vehicle manufacturer's instruction manual. Every vehicle has specific measurement values for vacuum related readings. It is beyond the scope of this manual to properly describe the correct procedure and test data for each vehicle.

**▲WARNING:** *Carbon monoxide is produced while a vehicle's engine is operating and is deadly in a closed environment. Early signs of carbon monoxide poisoning resemble the flu, with headaches, dizziness, or nausea. If you have these signs, the work area may not be vented properly. Get fresh air immediately.*

- Prior to using the Vacuum Pump, make sure to place the vehicle's transmission in "PARK" (if automatic) or "NEUTRAL" (if manual). Then, block the tires with chocks.
- Be alert for hot engine parts to avoid accidental burns.
- Avoid accidental fire and/or explosion. Do not smoke near engine fuel and battery components.
- Use the Brake Bleeder only with brake fluid. Do not attempt to use the tool to siphon any other liquids. Damage to the internal chamber and seal, or future brake fluid contamination may result.
- Follow guidelines for proper brake fluid disposal. Used brake fluid should be removed from the vehicle and properly recycled. Many states require recycling. Contact your local solid/liquid waste authority for information on recycling. Do not reuse old brake fluid.
- Brake fluid is corrosive. Avoid spilling it on the vehicle's exterior, it can harm automobile paint.

**▲WARNING:** *People with pacemakers should consult their physician(s) before using this product on a running engine. Electromagnetic fields in close proximity to a heart pacemaker could cause interference or failure of the pacemaker. In addition, people with pacemakers should adhere to the following: Caution is necessary when near the coil, spark plug cables, or distributor of a running engine. The engine should always be off if adjustments are to be made to the distributor.*

**▲WARNING:** *Always release the vacuum in the Vacuum Pump before performing any inspection, maintenance, or cleaning.*

- Before each use: Inspect the general condition of the Vacuum Pump. Check for misalignment or binding of moving parts, cracked or broken parts, damaged Hoses, loose connections, and any other condition that may affect its safe operation. If a problem occurs, have the problem corrected before further use. Do not use damaged equipment.

**▲WARNING:** *The warnings, precautions, and instructions discussed in this manual cannot cover all possible conditions and situations that may occur. The operator must understand that common sense and caution are factors which can not be built into this product, but must be supplied by the operator.*

## ENGINE DIAGNOSTICS

**NOTE:** Measurements and illustrations are for reference only. Your test results may vary.

### NORMAL ENGINE

1. With the vacuum pump connected to an intake manifold vacuum port.
2. Start engine, bring to normal temperature and let idle.
3. Look at the needle's movement on the gauge. At idle, the needle should read 16-22 in. of Hg and hold steady. This is your base line, indicating everything functioning normal.

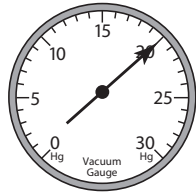

### WEAK OR BROKEN VALVE SPRING

- A sign of weak valve springs are when the pointer on the vacuum pumps gauge fluctuates rapidly between 10 and 21 in. of Hg at idle. As the engine speed increases the fluctuations will increase too.
- A broken valve spring will still cause the needle to fluctuate rapidly at regular intervals. The difference can be seen every time the cylinder fires and the valve attempts to close.

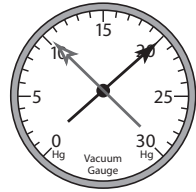

### STICKING VALVE

- A valve that's sticking will exhibit a rapid drop intermittently from a normal pointer indication. This is because a sticking valve or valves don't always stick on each cycle of the engine. To pin-point a sticking valve apply lightweight oil directly to each valve guide using a syringe with a fine tip. As the oil coats the guide the sticking valve will temporarily function normal. The needle on the gauge will be steady until the oil burns off.

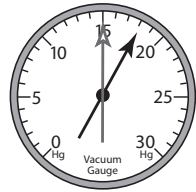

### BURNED OR WORN-LEAKING VALVE

- At idle, the pointer on the gauge will drop then return to normal. This would happen at regular interval. Every time the cylinder fires with the bad valve it will cause the needle to drop to a low reading. The needle will drop from 1 to 7 in. of Hg, then return to a normal reading.

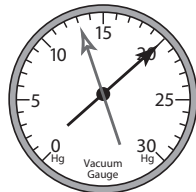

### WORN VALVE GUIDES

- A worn valve guide lets air into the cylinder, this changes the air/ fuel mixture. The needle on the gauge will run lower than normal, approx. 3 in. of Hg and will fluctuate rapidly. When you increase the speed of the engine the needle will stop fluctuating.

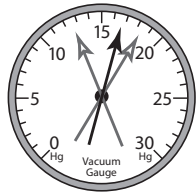

### BLOWN CYLINDER HEAD GASKET

- At idle, the needle will fluctuate from normal to a low reading. Each time the affected cylinder reaches firing position the needle will drop sharply. You should see about 10 in. of Hg drop from normal, then return.

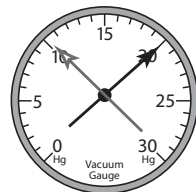

## ENGINE DIAGNOSTICS CONT.

### LEAKING PISTON RING

- If you experience leaking rings the vacuum at idle will be low with the needle holding steady between 12 and 16 in. of Hg.
1. To test open the throttle.
  2. Increase the engine speed to about 2000 RPM.
  3. Then close the throttle quickly and watch the needle of the gauge. It should jump 2 to 5 in. of Hg above its lowest reading. A lesser gain may indicate faulty rings, and a complete cylinder leakage or compression test should be done.

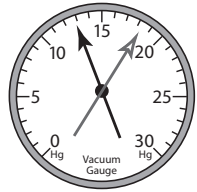

### IDLE AIR/FUEL MIXTURE

- A sweeping change of 4 to 5 in. of Hg back and forth at idle indicates a rich fuel mixture. With a lean mixture the needle will drop irregularly over about the same range.

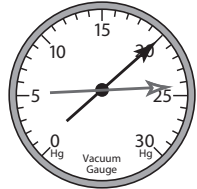

## TESTING PROCEDURES

### INTAKE MANIFOLD LEAK

1. With the vacuum pump connected to an intake manifold vacuum port.
2. Start engine, bring to normal temperature and let idle.
3. Look at the needle's movement on the gauge.
  - If you have a bad gasket, or cracked hose this could cause air to leak into the intake system. If this happens, the needle will read about 4 to 9 in. of Hg below normal, and will remain steady.

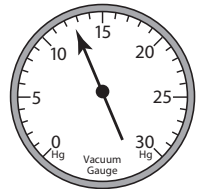

### EXHAUST GAS RECIRCULATION (EGR)

1. With the vacuum pump connected to an intake manifold vacuum port.
2. Start engine, bring to normal temperature and let idle.
3. Note the needle's movement on the gauge.
  - The needle should read 16-22 in. of Hg and hold steady.
4. Increase the engine speed to approx. 2000 RPM.
  - As the speed increases slowly, so should the vacuum. This indicates the EGR valve is operating properly.
  - If the needle drops, moving toward zero you have a malfunctioning EGR valve.
- To test:
  1. Remove the EGR valve from the manifold.
  2. Connect your vacuum tester to the diaphragm on the EGR valve.
  3. Pump the trigger of your tester building vacuum. The needle should not move and hold steady. If the needle starts to drop, your EGR valve has a crack/hole in the diaphragm.

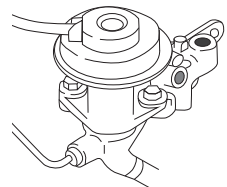
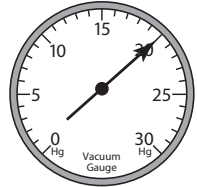

## TESTING PROCEDURES CONT.

### FUEL PRESSURE REGULATOR

**NOTE:** To verify a Fuel Pressure Regulator is functioning properly you'll need a Fuel Pressure Tester along with your W87032 Vacuum Tester.

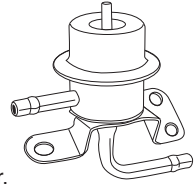

1. Do a visual check for leaks around the regulator or signs of cracks or fuel in the vacuum line at the diaphragm.
  - If you find a leak or fuel in the vacuum line replace the regulator.
2. Install the Fuel Pressure Tester to the rail.
3. Start the engine and bring it to temperature and let idle.
4. Disconnect the vacuum line from the fuel pressure regulator at the diaphragm.
  - Looking at the pressure tester, the fuel pressure should have increased 10 to 12 psi. If nothing changes the regulator or vacuum line is bad.
5. Confirm the condition of the vacuum line by connecting it to the Vacuum Pump.
  - The needle should hold steady at 16 to 22 inches of Hg.
  - If you have a low, or no reading the vacuum hose is plugged or bad.
6. Disconnect the Vacuum Pump from the vacuum hose and plug it.
7. Attach the Vacuum Pump to the diaphragm on the pressure regulator.
8. Apply vacuum to the regulator and watch the gauge of the Fuel Pressure Tester. The fuel pressure should increase approx. one pound for every two inches of vacuum applied to the regulator. If it doesn't the regulator is bad and needs to be replaced

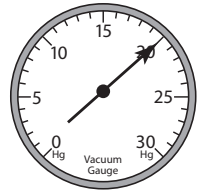

### ELECTRICAL /VACUUM SOLENOID

1. Disconnect vacuums and electrical connectors, make note of the hose locations.
2. With no power to the solenoid, attach the vacuum pump to port "A".
3. Apply vacuum, and watch the gauge.
  - The vacuum should reduce to zero after each pump. The vacuum is released through the other port, "B".
4. Apply power to the solenoid by using alligator leads. Ground the negative side to a good metal bracket or frame. Add 12 volts to the positive side from the battery.
5. Now when you apply vacuum it should not bleed off, holding steady.
6. With the solenoid still connected to power, switch the hose from your pump to the other side of the solenoid port "B".
7. Now apply vacuum, again it should bleed of. This time through the intake system.

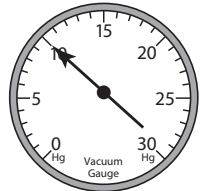
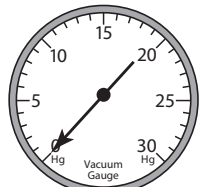
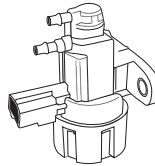

### THERMAL VACUUM VALVES

**NOTE:** Called different names depending on the make of vehicle:

- GM - Thermal Vacuum-Switches (DTVS)
- Chrysler/Jeep - Thermal Ignition Control (TIC)
- Ford - Ported Vacuum Switches (PVS)

These two-port valves all have the same function, control exhaust gases from recirculating. When the engine is cold the valve should be closed.

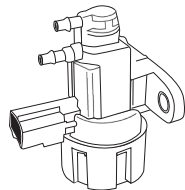

## TESTING PROCEDURES CONT.

1. Attach the vacuum pump to the bottom port and apply vacuum, approx. 10 in. of Hg.
  - The needle should hold steady and not bleed off.  
If it does not hold, unit is bad and should be replaced.
2. Repeat the procedure after the engine has warmed to normal temp.
  - As vacuum is applied it should bleed off to zero. If it holds steady, unit is bad and should be replaced.

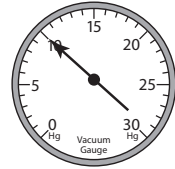
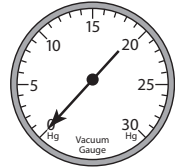

**NOTE:** These thermal switch are needed to provide good drive ability. It limiting the entrance of exhaust gases until the engine is warmed up. Depending on the vehicles make your thermal switch may have more than two ports. You may have three or four ports, the end function is the same. They control vacuum going to different applications until the engine has warmed to normal operating temp. Consult your service manual for the type used on your vehicle.

## BLEEDER PUMP ASSEMBLY

1. Attach a 3 in. Vacuum Hose (8) to the bottom of the Jar Lid (4). (See Figure A.)
2. Attach a 24 in. Vacuum Hose (7) to the top of the Jar Lid (4) marked "TO PUMP". Then, attach the other end of the 24 in. Vacuum Hose (7) to the Vacuum Pump (1). (See Figure B.)
3. Press one of the small rubber jar gaskets from the kit into the inner lip of the 4.5 ounce Reservoir Jar (6). Add a touch of light oil to the gasket to insure the gasket won't get pinched and for a good seal. Twist the Jar Lid (4) onto the Reservoir Jar (6), it's about 1/8 turn, do not over tighten.

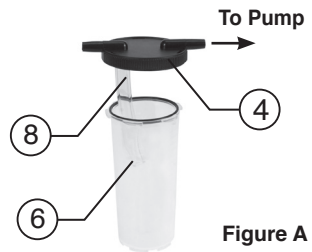

Figure A

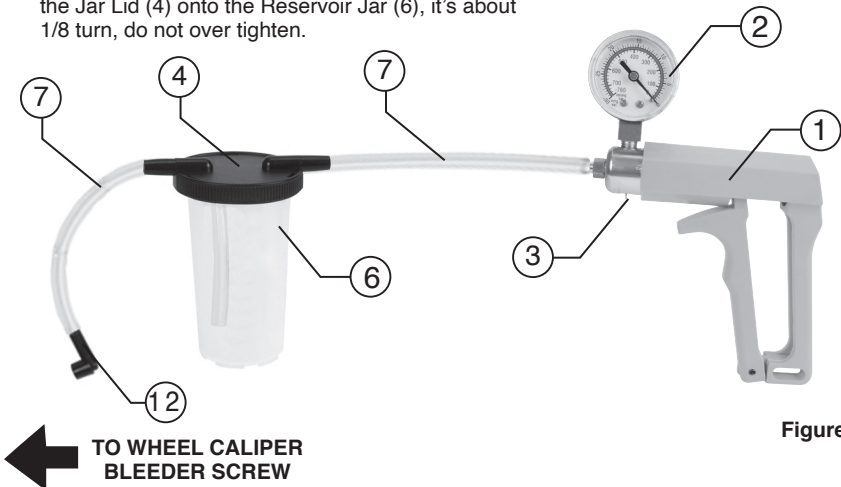

Figure B

4. Connect the other 24 in. Vacuum Hose (7) to the remaining port on the Jar Lid (4) and then connect the other end to the Brake Bleeder Screw Adapter (12).
5. With your finger over the adapter opening squeeze the handle of the Vacuum Pump (1) a few times to create a vacuum in its Reservoir Jar (6). Press the the Vacuum Release Valve (3) to release the pressure.



## BRAKE BLEEDING INSTRUCTIONS

**▲ CAUTION:** Always use the DOT Brake Fluid specified for your vehicle, the most common are listed below.

*DOT3, DOT4, and DOT5.1 are glycol-based fluids, and DOT5 is silicon-based. One difference is DOT3, DOT4, and DOT5.1 absorb water, while DOT5 doesn't. Another important characteristic is, as the DOT number raises so does its boiling point. Although DOT5 and DOT5.1 have similar boiling points, they CANNOT be mixed. DOT5 is silicone based and DOT5.1 is glycol based and mixing the two will destroy the seals in the brake system. DOT5.1 can be used as an upgrade or replacement for both DOT3 and DOT4.*

*Anytime a brake system is opened to replace components such as calipers, wheel cylinders, master cylinder, brake lines or hoses, air could get inside. This air must be removed by bleeding the brakes to achieve a firm brake pedal. Any air trapped in the lines, calipers or wheel cylinders will make the pedal feel soft and spongy when depressed. Air is compressible, so any air bubbles in the system will be compressed first. Then as you continue to apply the brakes, the hydraulic fluid transmits pressure to apply the brakes. Air in the system takes away from your ability to apply full braking power.*

### DIAGNOSTICS

Trouble shooting an unknown brake problem, or doing a complete brake conversion or rebuild. The first thing to look at is the master cylinder. Here are a few symptoms of a faulty master cylinder.

- **Spongy or Unresponsive:** Brake pedal that doesn't produce the desired stopping ability.
- **Contaminated Fluid:** As the seals inside of your master cylinder wear out, the rubber crumbles and degrades, often resulting in visual contamination of the brake fluid.
- **Brake Drag:** This happens when brakes are applied, but when released the piston doesn't return fully. Seals have failed and are holding the piston in the pressure position.

You've found that you have a faulty master cylinder, the first thing to do after getting the replacement is bench bleed it. Once that has been completed and everything installed, then bleeding off the rest of the system can be done. Bench bleeding the master cylinder is the starting point. It's simple and best done on the bench, out of the vehicle. There are several ways to do the job, some involve special threaded adapters for the exit ports that use tubes that return fluid to the reservoir. Another way is a special syringe that forces fluid through the exit ports. Using the vacuum pump is the most natural way insuring all the air bubbles have been removed, and the cylinder is getting completely filled.

### BENCH BLEED THE MASTER CYLINDER

Your new master cylinder will come with plugs in the outlet holes, leave them for now.

1. Gently clamp the unit in a vise using the mounting flange with the push rod end slightly elevated. Do not clamp the master cylinder body or reservoir as severe damage will occur.
2. Fill the master cylinder three quarters full with the vehicles recommended brake fluid type and, keep it filled at all times during the procedures.
3. Remove one of the plugs from the master cylinder and attach the proper adapter to the outlet port. Connect the pump tube to the reservoir jar and the jar tube to the adapter. Connect your vacuum pump to the pump side of the reservoir jar.
4. Operate the pump and observe air and fluid flowing into the reservoir until clear. Continue pumping until a bubble-free fluid appears. It may take 4-5 pumps before that circuit is full and free of air.

## **BRAKE BLEEDING INSTRUCTIONS CONT.**

5. Replace the plug tightly, move to the second outlet port and repeat the steps for the second circuit. Be sure to replace the plugs tightly because hydraulic pressure will be applied in the next step.
6. Now adjust the master cylinder in a vise with the push rod end down slightly. Slowly push the master cylinder push rod in about a 1/8", release it should return to its original position. Repeat this several times until no air bubbles can be seen in the reservoirs. If your master cylinder doesn't have a push rod use a rounded piece of wood, or something that won't harm the push rod seat. Slotted and Phillips screwdrivers seem ideal, but can damage the seat or the rear seal.
7. Remount the master cylinder with the push rod end up slightly and repeat the bleeding steps from above one more time. Plug both outlet ports tightly.
8. The master cylinder is now free of air and ready to install.

### **ANTI-LOCK BRAKE**

Many newer vehicles are equipped with an Anti-Lock Brake System. Some of those could include the use of a high pressure pump to keep the system pressurized. Special procedures are needed when servicing. Consult your service manual for those procedures.

Observe the following precautions when servicing Anti-Lock brake system:

- ALWAYS wear safety goggles when servicing high pressure brake systems.
- ALWAYS depressurize the ABS system prior to servicing, making repairs or adding fluid.
- NEVER loosen a hydraulic line or open a bleeder fitting while the ABS system is pressurized.
- NEVER use silicone brake fluid in ABS equipped vehicles. Consult service manual for brake fluids type.
- ALWAYS reference the manufacturer's service manual for information on Anti-Lock brake systems.

### **DEPRESSURIZING ANTI-LOCK BRAKE SYSTEMS**

This procedure works on most Pressurized Anti-Lock brake systems. Always refer to the appropriate service manual for manufacturer's information on depressurizing procedure. Ignition switch has been turned off, and the negative battery clamp has been disconnected.

1. First pump the brake pedal until a change in the pedal pressure is felt. This takes 25 or more pumps before a noticeable change is felt.
2. Pump the pedal a few more times, this will remove most system pressure.
3. Open the fluid reservoir or loosen brake lines, but still use caution. Leave the reservoir off if you intend to change the brake pads prior to bleeding the brakes.
4. Top off the brake fluid with what's recommended for your vehicle.
5. Reconnect negative battery clamp when finished.

### **BLEEDING ANTI-LOCK BRAKE SYSTEMS**

Bleeding the brakes after brake any components have been replaced is a step you don't want to skip. Air trapped in the lines, calipers or wheel cylinders will make the pedal feel soft and spongy. Air is compressible, so any air bubbles in the system will get compressed first. Then as you continue to apply the brakes, the hydraulic fluid transmits pressure to apply the brakes. Typically the front brakes on most Anti-Lock brake systems can be bled in the usual manner. Some automotive manufacturers use bleeding procedures which require specialized equipment. Always reference the manufacturer's service manual for the proper

## **BRAKE BLEEDING INSTRUCTIONS CONT.**

brake bleeding procedure. If the only components you replaced were downstream of the ABS modulator, chances are normal bleeding procedures will clear the lines of any unwanted air. Components such as the calipers, wheel cylinders, brake hoses or lines, these are downstream. The most common bleeding procedure is to bleed the brake furthest from the master cylinder first, passenger rear. Then follow the brake line to the other brake that shares the same brake circuit. Typically it's the rear brake on the driver's side of most cars and trucks. Sometimes it's the opposite front brake on a front wheel drive car or minivan.

Always refer to the vehicle manufacturer's recommended bleeding sequence as this may vary from one application to another depending on how the system is configured. Then bleed the other brake circuit starting with the furthest brake from the master cylinder. If the repair involves replacing the master cylinder, a brake line or valve ahead of the ABS modulator. Or, if replacement of the modulator or high pressure accumulator was needed. This is where the vehicle's service manual becomes a necessity. Some ABS modulators have special bleeder screws to help vent the air when bleeding the system. Others don't and require an OBDII scan tool to cycle the ABS solenoids while you bleed the system.

### **BRAKE LINE BLEEDING**

Most low and soft pedal problems are caused by air in the hydraulic lines, wheel cylinders and calipers. The solution requires bleeding of the hydraulic brake system. By using the pump with brake bleeding accessories, the system can be bled easily in a short period of time. The vacuum pump kit provides a simple, clean, and quick method for bleeding the fluid lines in the automotive brake system.

The order on most cars is starting with the passenger rear brake first, then driver rear, then passenger front and finishing with the driver front. All bleeding fittings must be clean prior to beginning the bleeding procedure. Dirt or contaminants can enter an open bleeder valve. Be sure to check the brake fluid level in the master cylinder after bleeding each brake. Don't let fluid drop below the indicator line inside the reservoir. The vacuum pump creates a vacuum as you pump the handle, causing fluid to be drawn into the reservoir. Tiny bubbles may form in the hose after the air is bled from the lines. This air is seeping around the threads of the loosened bleeder fitting as you pump the trigger of the vacuum pump. Fill the master cylinder reservoir with new, clean brake fluid. Be sure to have plenty of the proper DOT type for your vehicle handy. Keep the lid on, but close by to top off the reservoir after bleeding each wheel.

**NOTE:** *Follow manufacturer's recommended bleeding sequence (if known). Begin at the corner furthest from the driver and proceed in order toward the driver. (Right rear, left rear, right front, left front.) While the actual sequence is not critical to the bleed performance it is easy to remember the sequence as the farthest to the closest.*

### **VEHICLE BLEEDING PROCEDURE**

1. Find the wrench that fits your bleeder fitting on the caliper. Longer box end wrenches work best for this. They help prevent stripping of snapping off the fitting. See Performance Tools W80616, W80617, W80619, or W80620.
2. Place the wrench on the brake bleeding fitting. Select and press the adapter over the top of the fitting.
3. Pump the handle several times, open fitting slightly watching for clean brake fluid and fewer bubbles. It only takes about a 1/4 turn for fluid to flow into the jar. The vacuum created should draw brake fluid as soon as the bleeder valve is opened. If it's not, make certain the lid of the jar is tight. Vacuum cannot build if the lid was not replaced

## **BRAKE BLEEDING INSTRUCTIONS CONT.**

securely. Additionally it's possible to have dirt in the bleeder valve. When that happens you won't be able to build the adequate amount of vacuum for the pump to work efficiently. Road grime could've solidified inside the bleeder valve. If this happens open the bleeder valve, have a helper apply pressure on the brake pedal slowly. At the same time pump the handle of the vacuum pump. The build of pressure should clear any debris that could've been plugging the valve. Be cautious not to over fill the pumps reservoir jar. You do not want brake fluid reaching the vacuum pump, the fluid will damage the seals.

4. After expelling about 3 oz. into the jar, close the fitting.

**▲WARNING:** *NEVER remove the jar lid before releasing the vacuum in the vacuum pump.*

5. Empty the jar, check for any dirt or debris before replacing the lid on the jar. Check the master cylinder, add fluid if needed.
6. Reopen fitting and continue until all air is extracted.
7. Repeat these steps on all remaining wheels. Pay attention to the fluid level in the master cylinder.
8. When complete, continuing to draw vacuum, tighten bleeder fitting.
9. When bleeding is complete pump the brake pedal several times. Pedal should have a positive, solid feel. If not, inspect lines and calipers to ensure all fittings are tight. If brake still feels slack, repeat bleeding process.

### **MOTORCYCLE BLEEDING PREPARATION - FRONT**

- The brake caliper piston must not be seized. The pistons must be free to move within the calipers.
- The master cylinder piston must not be seized. Piston must return to end of its stroke when released.
- Inspect brake lines for cracks or wear, and that all fittings are tight.
- Cover any painted surface near the brake master cylinder with plastic sheeting. Severe damage is caused by the brake fluid eating through the paint. Unprotected it will break down the paint exposing bare unprotected metal.
- Pump the brake lever to insure the front brake pads is seated against the rotor.
- Remove screws or the cap off the master cylinder reservoir, fill reservoir. If equipped with sight glass fill to indicator mark in window.

### **MOTORCYCLE FRONT BRAKE BLEEDING PROCEDURE**

1. Place the wrench on the brake bleeding fitting of the front wheel. Select and press the adapter over the top of the fitting.
2. Pump the handle several times, open fitting slightly watching for clean brake fluid and fewer bubbles. It only takes about a 1/4 turn for fluid to flow into the jar.
3. Be cautious not to over fill the vacuum pump reservoir jar. Avoid brake fluid reaching the vacuum pump, the fluid will damage the seals.
4. After expelling about 3 oz. into the jar, close the fitting.

**▲WARNING:** *NEVER remove the jar lid before releasing the vacuum in the vacuum pump.*

## BRAKE BLEEDING INSTRUCTIONS CONT.

5. Empty the jar, check for any dirt or debris before replacing the lid on the jar. Be cautious, master cylinders on motorcycles don't hold much, add fluid if needed.
6. Reopen fitting and continue until all air is extracted.
7. When complete, continuing to draw vacuum, tighten bleeder fitting.
8. Top off front reservoir and reinstall cover. Pump lever several times, pedal should have a positive, solid feel. If not, inspect line to ensure all fittings are tight. If brake still feels slack, repeat bleeding process.
9. If there is still an issue contact a professional technician for the make and model of the bike.
10. When equipped with dual disc front brakes, repeat bleeding process as though there are two separate systems following steps from above.

### MOTORCYCLE BLEEDING PREPARATION - REAR

Bleeding air from the rear brake system follows the same procedure as the front. The rear reservoir is usually located under a side cover, with a hose leading to the rear master cylinder.

- The brake caliper piston must not be seized. The pistons must be free to move within the calipers.
- The master cylinder piston must not be seized. Piston must return to end of its stroke when released.
- Inspect brake lines for cracks or wear, and that all fittings are tight.
- Cover any painted surface near the brake master cylinder with plastic sheeting.
- Pump the rear brake pedal to insure the rear brake pads is seated against the rotor.
- Remove the cap from the rear master cylinder reservoir, fill reservoir if needed. Pay attention to the full indicator mark on the outside of the reservoir, do not over fill.

### MOTORCYCLE REAR BRAKE BLEEDING PROCEDURE

1. Place the wrench on the brake bleeding fitting on the rear wheel. Select and press the adapter over the top of the fitting.
2. Pump the rear brake pedal several times, open fitting slightly watching for clean brake fluid and fewer bubbles. It only takes about a 1/4 turn for fluid to flow into the jar.
3. Be cautious not to over fill the vacuum pump reservoir jar. Again, avoid fluid reaching the vacuum pump.
4. Extract about 3 oz. into the jar, close the fitting.

**▲WARNING:** *NEVER remove the jar lid before releasing the vacuum in the vacuum pump.*

5. Empty the jar, check for dirt, and replace the lid. Remember, motorcycles master cylinders don't hold much, add fluid if needed.
6. Reopen fitting and continue until all air is extracted.
7. When caliper is complete, continuing to draw vacuum, tighten bleeder fitting.
8. Top off front reservoir and reinstall cover. Pump brake pedal several times, pedal should have a positive, solid feel. If not, inspect line to ensure all fittings are tight. If brake still feels slack, repeat bleeding process.
9. If there is still an issue contact a professional technician for the make and model of the bike.

## TROUBLE SHOOTING

- When you depress the brake pedal hydraulic force is transferred to the brake calipers. Air is much less dense when compared to the brake fluid. This means if air is in the lines it will compress too easily. When this happens, your brakes will feel too soft or even spongy. Bleed system
- If brakes continue to be unresponsive and soft, you may have water in the system. Water has a much lower boiling point than brake fluid. With excessive use brakes get hot. If the liquid in the systems reaches a boiling point, you could lose your brakes. The pedal and brake lever might be unresponsive and not pump up, causing the vehicle not to stop. Have your brake fluid tested, if contaminated have the system serviced by a professional mechanic.
- Brake squeaks slightly after bleeding, when applied. Clean the rotors and add Disc Brake Quiet aerosol spray to the back of the pads.
- Original equipment rubber brake hoses have a tendency to expand, which also causes spongy brakes. With time they lose the ability to flex and bend, replace with braided steel lines. They don't expand and offer a firmer, more consistent braking experience.

## CARE AND MAINTENANCE

1. Tool service must be performed only by qualified repair personnel. Service or maintenance performed by unqualified personnel could result in a risk of injury.
3. When cleaning: Do not clean the vacuum pump with cleaners or other solvents not intended for use with plastic components. Use a clean cloth and, if necessary, a mild detergent. Do not immerse the Vacuum Pump (1) component in any liquid.
4. When storing: Never store fluid in the Reservoir Jar (6) of the vacuum pump. Always dispose of excess fluid properly, according to federal regulations.

**▲WARNING:** *All maintenance, service, or repairs not listed in this manual are only to be attempted by a qualified service technician.*



**▲WARNING:** *It is the owner and/or operators' responsibility to study all WARNINGS, operating, and maintenance instructions contained on the product label and instruction manual prior to operation of this product. The owner/operator shall retain product instructions for future reference.*

*The owner and/or operator are responsible for maintenance, maintaining all decals or warning labels and while in use, maintaining the unit in good working order. If the owner and/or operator are not fluent in English, the product warnings and instructions shall be read and discussed with the operators' native language by the purchaser/owner or his designee. Make sure that the operator comprehends its contents. Safety information shall be emphasized and understood prior to usage. The product shall be inspected per the operating instructions.*

*Users of this product must fully understand these instructions. Each person operating this product must also be of sound mind and body and must not be under the influence of any substance that might impair their vision, dexterity or judgment.*

*Protect yourself and others by observing all safety information.*

*Failure to comply with instructions could result in personal injury and/or property damage! If you encounter any problems or difficulties, please contact our customer service department at:*

*1-800-426-1262 between 6:30 a.m. and 4:30 p.m. Pacific time.*

## 1 YEAR WARRANTY

PERFORMANCE TOOL® extends only the following warranties, and only to original retail purchasers. These warranties give specific legal rights. Except where prohibited by local law, the law of the State of Washington governs all warranties and all exclusions and limitations of warranties and remedies. There may be other rights which vary from state to state.

PERFORMANCE TOOL® warrants the product to be free from defects in materials and workmanship under normal use and service. A defective product may be returned for a free replacement within 90 days from the date of purchase, provided that product is returned to place of purchase immediately after discovery of defect. After 90 days and up to one year from date of purchase, PERFORMANCE TOOL® will replace at no charge any parts which our examination shall disclose to be defective and under warranty. These warranties shall be valid only when a sales receipt showing the date of purchase accompanies the defective product or defective part (s) being returned. For part (s) after 90 days, please remit your request, postage prepaid to:

PERFORMANCE TOOL, P.O. Box 88259 Tukwila, WA 98138

These warranties exclude blades, bits, punches, dies, bulbs, fuses, hoses, and other consumables which must be replaced under normal use and service. These warranties shall not apply to any product or part which is used for a purpose for which it is not designed, or which has been repaired or altered in any way so as to affect adversely its performance or reliability, nor shall these warranties apply to any product or part which has been subject to misuse, neglect, accident or wear and tear incident to normal use and service.

PERFORMANCE TOOL® does not authorize any other person to make any warranty or to assume any liability in connection with its products.

Except for warranties of title and the limited express warranties set forth above, PERFORMANCE TOOL® makes no express or implied warranties of any kind with respect to its products. In particular, PERFORMANCE TOOL® makes no implied warranty of merchantability and no implied warranty of fitness for any particular purpose, except that for goods purchased primarily for personal, family or household use and not for commercial or business use, PERFORMANCE TOOL® makes an implied warranty of merchantability (and, if otherwise applicable, an implied warranty of fitness for a particular purpose), but only for the particular qualities or characteristics, and for the duration, expressly warranted above.

The laws on limitation of implied warranties may differ from state to state, so the above limitations may not apply in all cases.

PERFORMANCE TOOL® shall not be liable for consequential, incidental or special damages resulting from or in any manner related to any product, or to the design, use, or any inability to use the product. The sole and exclusive remedy for a defective product or part shall be the repair, or replacement thereof as provided above. The laws on limitation of remedies or on consequential, incidental or special damages may vary from state to state, so the above limitations may not apply in all cases.