

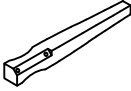



Assembly Instructions, #11604 Two Drawer Coffee Table

Parts List

Item	Parts	Description	Quantity
A		Top Assembly	1
B		Legs	4

Hardware List

Item	Hardware	Description	Quantity
1		Allen Bolts	8
2		Flat Washers	8
3		Lock Washers	8
4		Allen Wrench	1

Assembly Steps

Step 1

- 1.1 Lay the Top Assembly (A) upside-down on a soft surface.
- 1.2 Pull the drawers out to expose the corner blocks to fasten the Legs.
- 1.3 Fasten the legs with (8) bolts, flat washers and lock washers using the Allen wrench. Tighten.

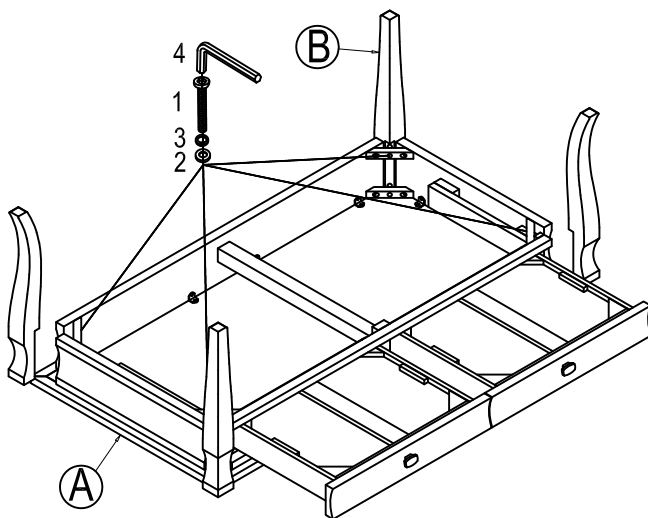

Step 2

- 2.1 Push the drawers back in.
- 2.2 Position the assembled piece upright.

