

Smart Toilet

USER MANUAL

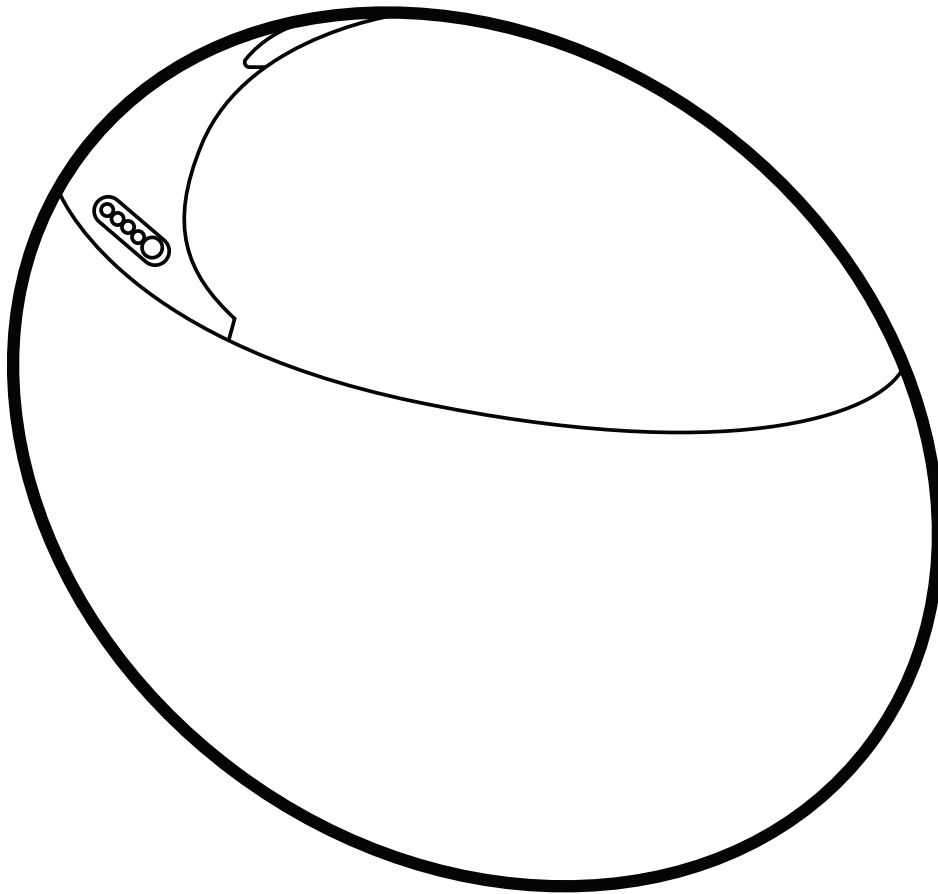



PRIOR TO INSTALLATION:

- Inspect toilet to ensure no damages have occurred while in shipping.
- Observe all plumbing and building codes in accordance with your state and local requirements.
- All dimensions are nominal! Be sure to measure your toilet prior to installation.
- The step-by-step guidelines in the installation instructions are a general reference. Should there be any discrepancies, Swiss Madison cannot be held liable. It is recommended to install all Swiss Madison products by hiring a licensed professional.
- Read installation and maintenance instructions thoroughly before installing. Be sure to use proper tools and always wear proper personal safety accessories for your protection.
- Two people are recommended to handle and install this product as it is fragile.

QUESTIONS OR CONCERNS?

Please contact us:

1-434-623-4766

info@swissmadison.com

INCLUDED PARTS:

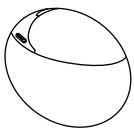

Smart Toilet



Flange Ring



Remote

SUGGESTED TOOLS & MATERIALS:



Safety Glasses

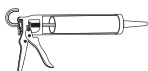

Glue Gun

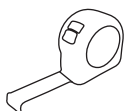

Tape Measure



Wrench

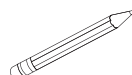

Marker



Screwdriver

INSTALLATION PREPARATIONS:

- Make sure that the floor tiles and the wall tiles have been paved, and that a pit tube and a water supply pipe are reserved.
- Reserve the installation position according to the dimensions given in the figure below (symbols * refer to the recommended dimensions) to ensure normal use of the water supply pipe.
- Make sure the distance between center of the pit tube and the wall, i.e., the pit distance, matches with the product.
- Turn on the water supply switch to drain water to flush away the mud and other foreign matters in the reserved water pipes to avoid blockage of the water pipes..

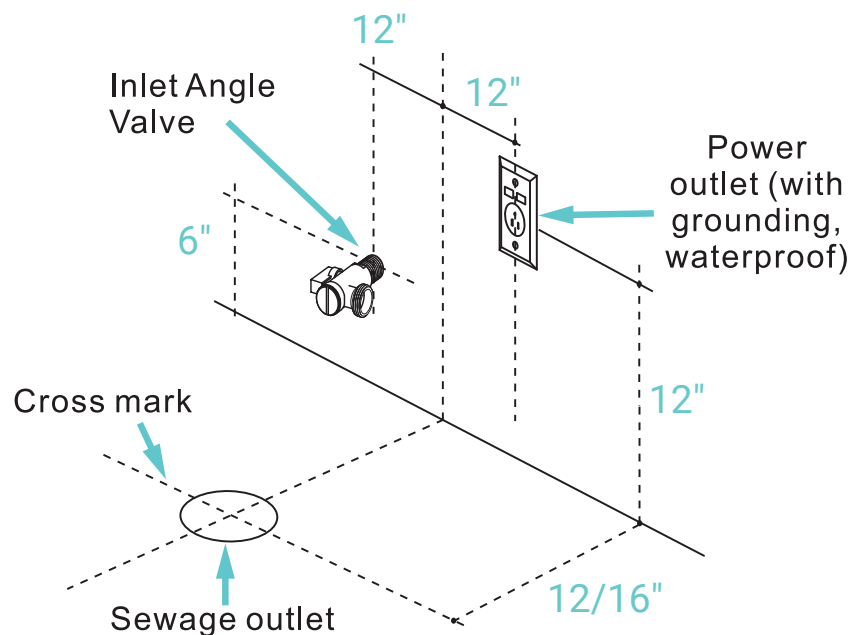

Be sure to set the power outlet as follows:

1. Confirming that the power socket used is handled by proper grounding.
2. The length of the power cord is 5 feet, and the location of the socket should be close to this product to facilitate installation and removal, and as far away from the bathtub as possible.
3. It is recommended to use a waterproof type socket, do not use an extension cord to connect this product.
 - May cause fire or electric shock.



Warning

INSTALLATION:

- 1 • For the bathroom newly installing a toilet, a flange with bolt shall be added.

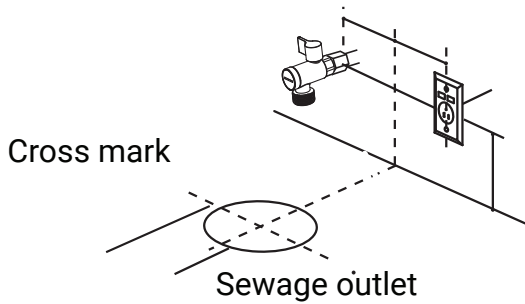

- 2 • Lift the flip lid assembly from the toilet, up from the inside.

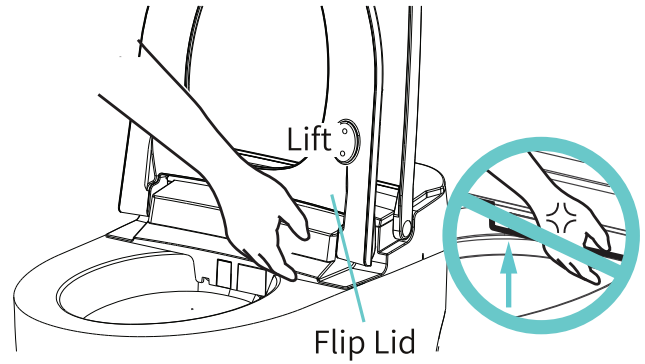

- 3 • Install the flange ring on the ceramic bottom drain and make a tight connection.

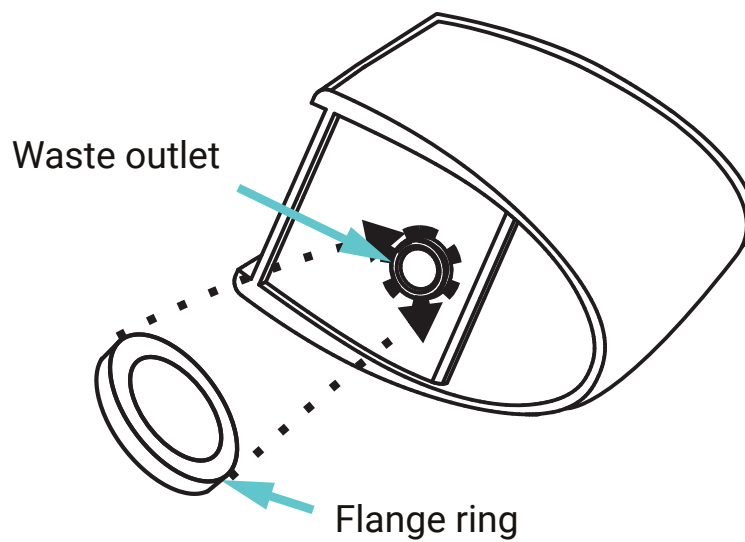

- 4** • Two people lift the ceramic, align the mark on the ceramic body with the cross mark on the ground, and slowly place the ceramic on the ground so that the two marks coincide. After the overlap, press the ceramic body downward so that the putty fully touches the ground and connects tightly with the ground.

Note: Do not move the ceramic body or rock it from side to side after the mark have coincided, otherwise the seal created by the putty may be broken, resulting in water leakage.

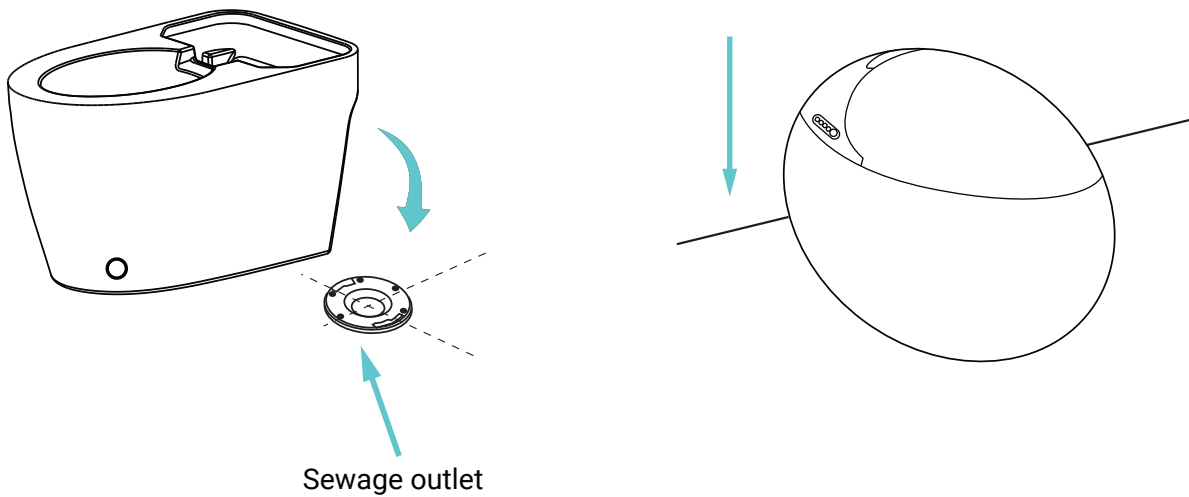

- 5** • Install the water inlet angle valve.

Note: Installation of water inlet angle valve before depending on the water quality must be drained for 2 to 5 minutes.

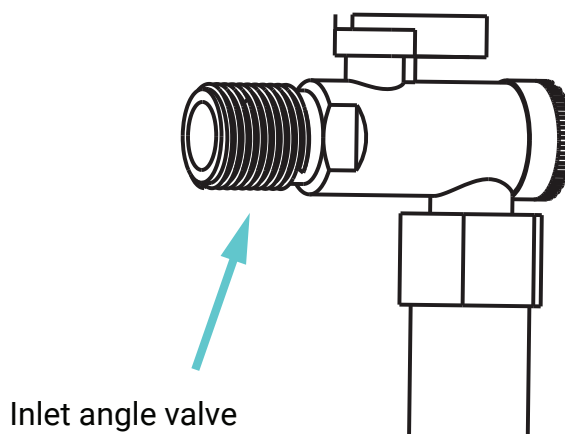

PLUMBING INSTALLATION:

Connect one end of the braided hose to the angle valve, when connecting, please do not tighten too much, otherwise it will damage the sealing ring and lead to water leakage in the pipeline.

CAUTION:

1. If the cleaning water line and ceramic flushing water line are separate models, two lines must be connected.
2. Open the water inlet angle valve to the maximum, make sure there is no water leakage in each connection part, if found leakage, please re-install.
3. Do not enter the pipe sealing material into the internal pipeline, otherwise it may cause the whole machine to fail.

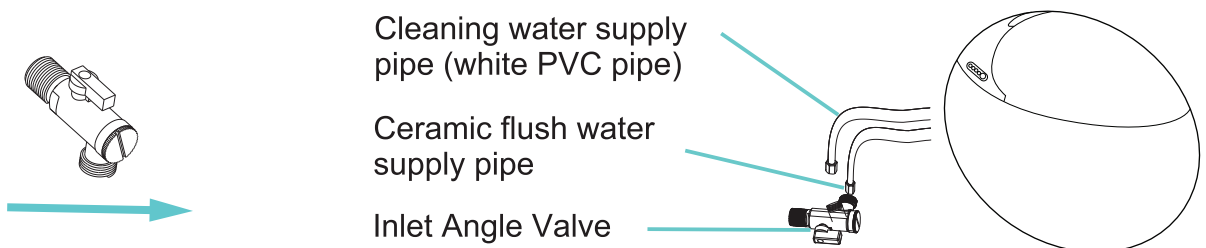

Remove the old water inlet angle valve and replace it with a new one.

NOTE: The water inlet hose must not be folded, otherwise the water pressure will be too low and the product will not work properly.

NOTE: This product has Vortex™ Flush technology. High water pressure can cause slight splashing above the ceramic wall. To avoid this, you may adjust the water inlet angle valve to reduce the water pressure.

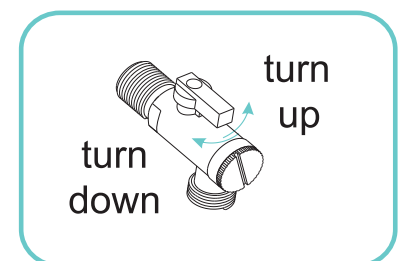

CAUTION:

In case of power failure during use, please close the angle valve and stop the water supply, and the function will be restored to normal after self-test.

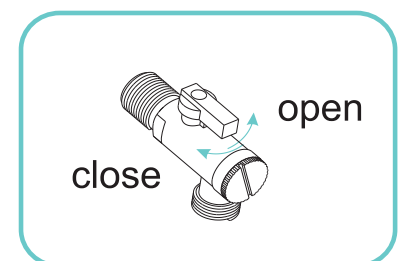

REMOTE CONTROL INSTALLATION

Remote Control Bracket

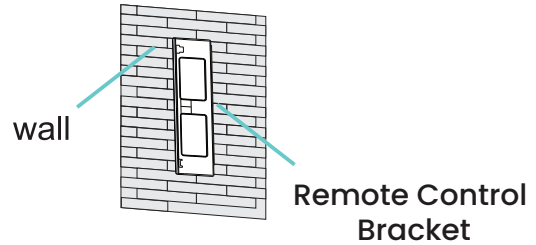
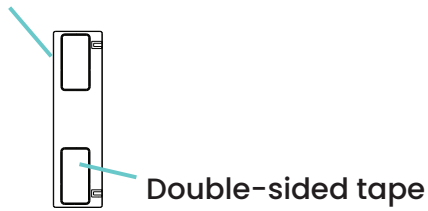

ATTENTION:

1. The installation location must be cleaned before pasting, press the tape hard and evenly when pasting, and use it after 15 minutes.
2. Double-sided adhesive tape is suitable for pasting tile-type flat wall, not suitable for pasting wallpaper-type wall.
3. Do not enter the pipe sealing material into the internal pipeline, otherwise it may cause the whole machine to fail.

TEST RUN

The first time you turn on the water and power, wait until the machine self-test is completed, then proceed to the following steps:

1. **Human Seat Sensor Function Test**
 - The area shown in the picture is the human body seating sensing area, when you turn on the washing and drying function, you must be seated. When you are seated, you will hear a "tick" to indicate that you are seated.
2. **Check the Basic Functions**
 - Operate the knob or the remote control "Hip Cleaning", each function should be normal, and there should be no water leakage, odor and noise and other undesirable phenomena.

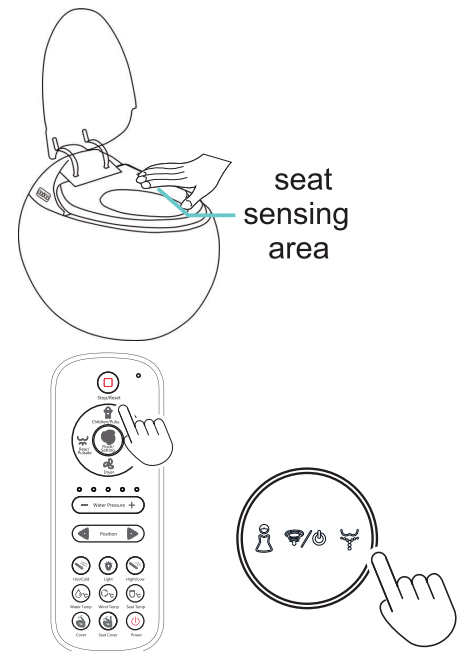

After the product functions normally, fill the uneven part of the ground with filler to make the ceramics stable, and use the glass glue gun to put glass glue along the bottom of the ceramics.

IMPORTANT: After the product is glued, please use it after 48 hours.



TROUBLE SHOOTING

FAILURES	INSPECTION METHODS	TROUBLESHOOTING
Product does not work	Check that the leakage protection power cord indicator light is on?	If not illuminated, check the external power supply to the circuit.
	Is the leakage protection power cord indicator light on and is it on?	Re-power on, or long press the knob for 3s to turn on the machine.
No water from nozzle	Check for water outages?	Pending restoration of water supply.
	Check that the angle valves are closed?	Open the angle valve.
	Check for clogged filters?	Cleaning filters.
	Check the inlet hose for bends?	Eliminate bent inlet pipes.
Insufficient cleaning strength	Check that the wash water pressure is set at a low setting?	Adjust the wash water pressure level according to the instructions.
	Check for clogged angle valve filters?	Cleaning filters.
Washer nozzle dripping	Does the water not drip after closing the angle valve?	Replace the water inlet solenoid valve, clean the angle valve filter.
Washing and drying functions do not work	Check to make sure it's tight against the seat sensing area?	Tight fit, still not working, the seating sensor is not working, replace the seating ring.
When drying, blowing cold air	Check that the warm air is set at room temperature?	Adjust the air temperature setting by referring to the instruction manual.
	Warm air heating parts are not damaged?	Replacement of drying assembly.
Water and seat temperature not heating	Check that the water and seat temperatures are set at room temperature?	Adjust the water and seat temperature settings according to the instructions.
Malfunction of the remote	Check if the remote control indicator light does not light up or is noticeably dimmed?	Replace with new batteries and install correctly.
Ceramics do not flush clean	Check for low external water pressure?	Pending restoration of water supply.
	Check for clogged angle valve filters?	Cleaning Angle Valve Filter.
	Check the inlet hose for bends?	Eliminate bent inlet pipes.
Water pressure is normal, flushing is not cleaning	Check for air leaks at the drain?	Re-installation.
	Check for blocked S-bends?	Purchase a tool to unclog it, such as a leather bolt, to unclog it.
Normal water pressure, no flush	Is there any beep on the main board when you press flush?	Yes, replace flushing components such as pulse valves.
	Is there any beep on the main board when you press flush?	No, replace related parts such as motherboard or remote control.
Cover/seat cover falling too fast	Can it be restored to normal after flipping the cover and ring into place?	Cannot be restored, replace damping assembly.
Sequential cycling of functions	Check if you have entered the engineering debug mode by mistake?	Unplugged and re-energized after one minute.



PRECAUTIONS FOR USE

Please do read and follow the instructions carefully before using. They are about safety of person.

Symbols and meanings

 Warning	Ignoring this tag may cause serious injury or death.
 Caution	Ignoring this tag may cause injury or property loss.

Symbols and meanings

	Dismantling is forbidden.
	Must follow.



No splash

It is forbidden to drop any water and detergent on the product or the electric plug.

- May cause fire or electric shock.
- May cause breakage or leaking.

The smart toilet is an electric product. Please avoid splash and use it in a wet environment. Maintain air circulation when the product is used in bathroom.

- May cause fire or electric shock.

Set the electric socket as below

- May cause fire or electric shock if not follow the instructions.
 - Please use a high-sensitivity and fast leakage switch for the circuit of the electric socket. Or to use insulated transformer (>1.5KVA, <3.0KVA).
 - The electric socket should be installed 0.3m at least up to ground and away from the bath tub.

Must install the ground wire

- May cause electric shock without ground wire.

Attn: The electric resistance should be 4Ω and the diameter of the copper wire should be 1.6mm or above.

Using the product in bathroom

Make sure the power plug has been waterproofed with silica gel.

- May cause fire or electric shock without waterproofing.



Do not use the product in wet environments.

- May cause fire or electric shock.



Dismantle, repair or remould the product are forbidden

- May cause fire or electric shock.



Do not touch the electric with wet hands.

- May cause electric shock.



Stop using the product while it has malfunction

- Please pull out the plug and turn off the inlet valve.



Do not damage the electric wire/connected toilet

Malfunction:

Leakage
Dehiscence
Abnormal sound & smell
Fuming & abnormal heating
Blocking

- Keep using the product while it has malfunction may cause fire or electric shock or leakage.

Do not pull, process, heat, forcefully bend the electric wire connected toilet.

Do not put heavy item onto the electric wire, connected toilet.

- Ignoring the breakage and keep using product would cause fire, electric shock or short circuit.



Do not use a unsteady socket

- May cause fire or electric shock.



Do not use the power socket with lots sockets

- Do not remould the wire we supply. That would cause fire or electric shock.



Do not use water sources other than city water

- May cause dermatitis.



Do not use the AC except the working voltage

- May cause fire.

PREVENT GETTING BURNT



Must follow

- Please set the seat temp. to home temp. if seating in a long time.
- Please set the seat temp. to home temp. and set the drying temp. to the lowest level for special people

Users people who can not adjust the temperature correctly like children, elder, disabled, paraplegia etc..

who take sleeping pills or over drinking or weary or drowsiness

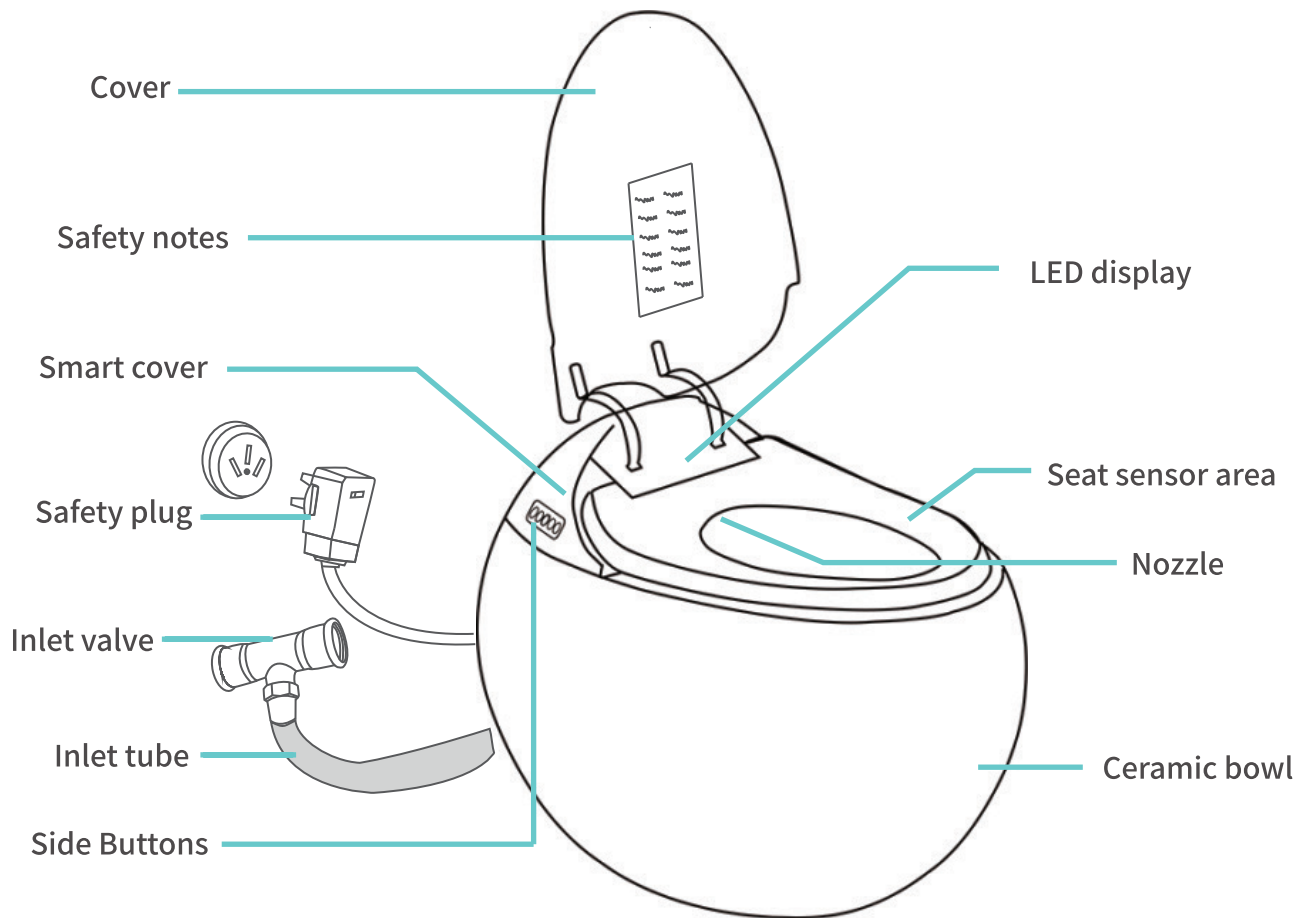

SIDE CONTROL PANEL DESCRIPTION

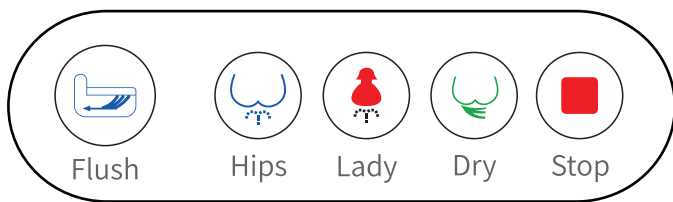

Flush Rear Bidet Dryer Stop
"Flush" Press this button to flush for one time. Only this button can work when the toilet is soft shutdown.



"Rear": Press this button to activate rear washing when a user is sitting on the toilet. Press twice to turn to moving washing. Press the "Stop" button to stop. And the function will stop when the toilet senses the seat is not taken.
When the seat is not taken, press the button will activate nozzle cleaning.

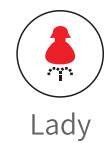

"Bidet": Press this button to activate bidet washing when a user is sitting on the toilet. Press twice to turn to moving washing. Press the "Stop" button to stop. And the function will stop when the toilet senses the seat is not taken.
When the seat is not taken, press the button will activate nozzle cleaning.

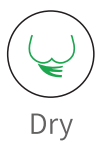

"Dryer": Press this button to activate dryer after flushing when a user is sitting on the toilet. Press the "Stop" button to stop.



Long Press the "Stop" side button, enter switch mode, Turn off/Turn on; Short Press "Stop" to stop all action at present.

LED DISPLAY

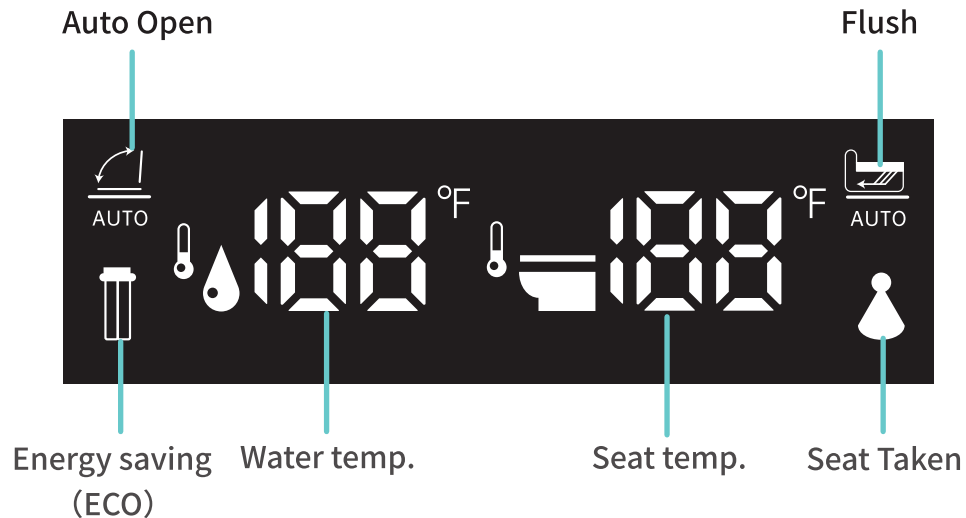

BEFORE USING:

Plug well

- Plug in the listed local voltage.
- Please the inlet valve is opened or not.

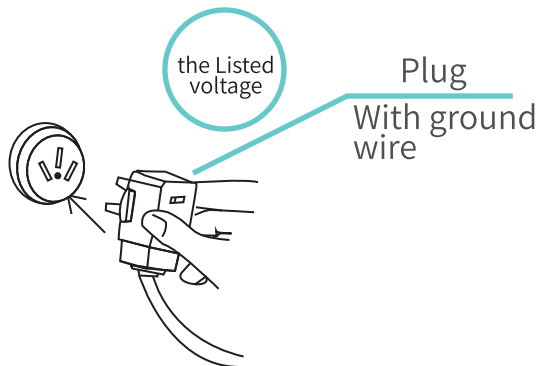

Leakage Protected Plug

- Please test once a month
- Press the "test" button
- Confirm that the "pilot light" is off
- Confirm that the product is out of work
- Press the "reset" button to boot the product if every step as stated above are OK

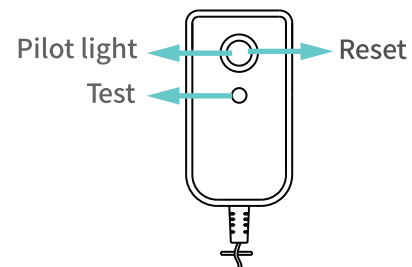

WARNING



- Please make sure the ground wire
- Please contact electrical installation company if your socket is without ground wire.
- The original electric plug is for triple electrode type.
- There will be a change of electric shock while the product is out of service.
- Ensure the proper installation of water pipe, tube and valve, otherwise that would cause leakage and loss.

Confirm Each Function:

1. The nozzle, water pipe and tube.
2. The light of “saving mode” on LED display should be off while the seat sensor area is covered.
3. Check the rear & bidet washing, defecation assist, deodorization and drying function is well or not.
4. Check the damping function is well or not.
5. Confirm that the seat is on working and the light of “saving mode” or the pilot light is off before checking the function of washing, drying and deodorization

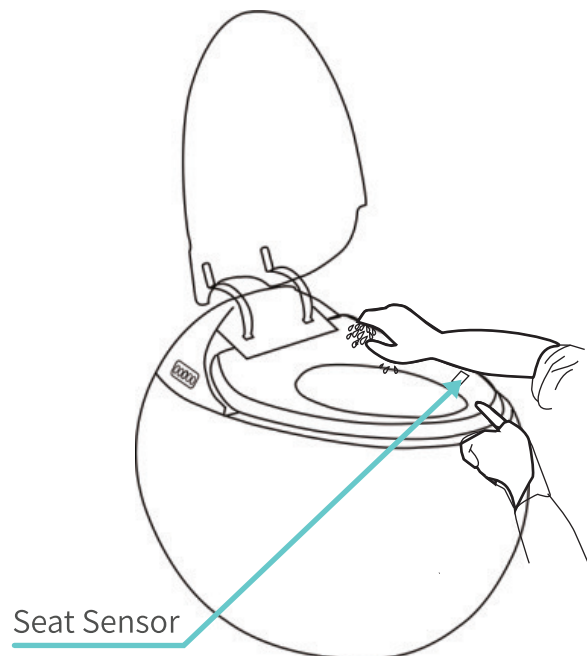
**CAUTION**

1. The washing function is for instant heating type. The function would be out of work if the water inlet has an error
2. Ensure the inlet valve is open and the inlet tube is not bent after the product is booted.



WARNING: Only the listed voltage is accepted. Please follow the relevant regulations for wiring. **Will cause fire if this warning is ignored**

REMOTE CONTROL INSTRUCTIONS

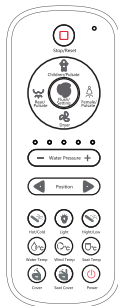

Remote Control Pairing

Step1: Unplug the power cord from the socket to cut off the power supply.

Step 2: Keep pressing the “bidet/female” key on the remote control until all indicating lights are flashing, then plug the the power cord of the smart toilet to the working socket, and wait until all lights are off to complete the pairing.

Please make sure there is sufficient power supply for the remote control before pairing. Cut off the power of the intelligent toilet for 30 seconds and then apply the above steps for paring to remote control.

REMOTE CONTROL OPERATION

Power on/off

Press the “Power”  button on the remote control to turn on the toilet, press the power button again to turn it off.

Seat Temp.

Press the “Seat Temp.”  button to set the seat to a level of high, medium, low, or room temperature.

Water Temp.

Press the “Water Temp.”  button to set the washing water to a level of high, medium, low, or room temperature.

Wind Temp.

Press the “Wind Temp.”  button to set the dryer wind to a level of high, medium, low, or room temperature.

Night Light

Press the “Light”  button to turn on or turn off the night light.

Rear washing

Press the “Rear”  button to activate the washing via the nozzle, press again to activate moving washing. (Rear washing can only be activated when a user is sitting on the toilet.)

Bidet washing

Press the “Bidet” 、 “Female”  button to activate the bidet washing, press again to activate moving washing. (Bidet washing can only be activated when a user is sitting on the toilet.)

Children

Press the “Children”  button will automatically run washing-dryer-flush step by step with medium temperature, press the “Stop” button to stop immediately. (This function can be activated with or without a user is sitting on the toilet.)

Hot/Cold Massage

Press the “Hot/Cold”  button to start with a switching high-low temperature of washing water. This can run simultaneously with rear washing or bidet washing.

High/Low Massage

Press the “High/Low”  button to start with a switching high-low pressure of washing water while the rear or bidet washing is working.

Position

Press the "Position"   button to adjust the nozzle forward or backward of moving washing while the rear, Children or bidet function is running. The nozzle will move forward and backward. Press the same button to stop moving.

Water Pressure Massage

Press the “Water Pressure” + – button to start with a switching high-low pressure of washing water while the rear or bidet washing is working.

Flush

Press the “Flush”  button will start flushing for one time. When the toilet senses a user leaves after sitting on it for more than 10 sec, it will automatically flush one time. And after the rear washing or bidet washing finishes working with a seated status, the toilet will automatically flush one time.



Dryer

Press the “Dryer”  button to start. Without manually stop, it will stop working after 3 mins.



Stop/Reset

Press the “Stop/Reset”  button to stop any running function like rear washing, dryer, etc.

Open Cover (optional function, subject to model)

Press the “Cover”  button to open the cover when it is closed. Press the “Cover” button  to close the cover when it is open. (This setting will not work with a seated status) (optional function, subject to model)

Open Seat Cover (optional function, subject to model)

Press the “Seat Cover”  button to open the seat cover when it is closed. Press “Seat Cover”  button to close the seat cover when it is open. (This setting will not work with a seated status) (optional function, subject to model)

Foot sensor



For model with an auto open seat cover, the cover seat will open itself while the foot sensor catches signal near the sensor area at the bottom right side. Perform the signal again to close seat cover.

For model without an auto open seat cover, the toilet will flush each time while the foot sensor catches signal near the sensor area at the bottom right side. (optional function, subject to model)

ECO (optional function, subject to model)

With an ECO feature, the seat temp. will be set to low level after the toilet is totally not used for more than 12 hrs, if the period extends to more than 48 hrs, the seat temp. will be set to deactivated.

Foam Shield (optional function, subject to model)

For model with the foam shield feature, press the “Dryer”  button or turn the control knob clockwise to start. Keep pressing the “Dryer”  button or turning the control knob clockwise for 5 sec to turn on/off auto foam shield mode. (auto start the foam shield with a seated status). The foam shield can also be set by pressing the “Stop/Reset” button for 5 sec with a seated status.

UV Sterilization (optional function, subject to model)

The UV Sterilization will start after 3 sec when a user leaves a seated status for more than 60 sec and the cover is close.

To reduce the risk of burns

The seat temp. will automatically reach the low level with a seated status, and it will return to its set temp. when the toilet is not used.

FUNCTIONS:

Seat Sensor On/Off (optional, subject to model)

Simultaneously keep pressing the “Night Light” and “water Pressure + or -” to adjust the seat sensing distance from minimum 00 to maximum 05.

Auto Flush On/Off

Keep pressing the “High/Low” button to turn on/off the auto flush after the seat is not taken. A sound of 3 times indicating off while a sound of 1 time indicating on.

Soft-Shutdown

Keep pressing the “Stop” on the side buttons to switch soft shutdown.

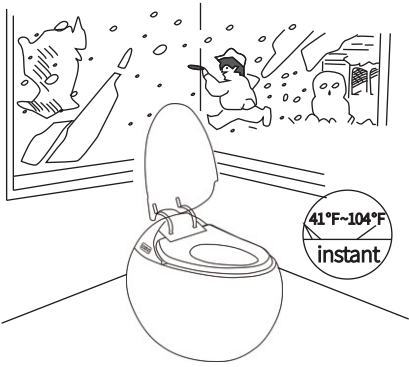
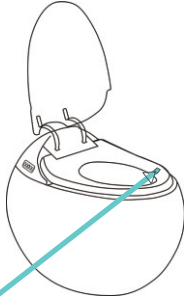

ATTENTION: A user can not use dryer and washing function while standing.

Water Temp.	Seat Sensor
<p>Capacity Instant heating device ensure the</p> <p>Water temp. base on level setting</p> <p>Normal: No heating Low : About 93°F Mid : About 98°F High : About 104°F</p> <p>The effect of heating depends on the water temp.</p> 	<p>The washing functions would not run by operation in error</p>  <p>Seat Sensor</p> <p>The seat sensor would not work if:</p> <ul style="list-style-type: none"> ※ No people the seat sensor area.

ONE YEAR LIMITED WARRANTY

Swiss Madison® products are made with quality materials and excellent craftsmanship to provide our customers with beautiful, durable, long-lasting products. Should there be any defects in materials or craftsmanship under regular use that are discovered within the first year of installation, Swiss Madison® will provide replacement parts at no charge, or at its discretion, replace any product or part of the product that is deemed defective, under normal installation, use, service or maintenance. This warranty applies only to the original purchaser. Proof of purchase will be required in the instance of a claim.

Swiss Madison® recommends all installations of Swiss Madison® products to be conducted by a licensed, professional plumber or contractor. Swiss Madison® will not be held responsible for any damage or product failure due to improper installation, misuse, or failure to utilize a licensed professional for installation. Swiss Madison® is not responsible for any installation or removal costs.

THIS ONE YEAR LIMITED WARRANTY WILL BE VOIDED IF:

- The installation recommendations were not followed by the installer
- The product has been moved from its initial place of installation
- The product has in any way been modified from its packaged state
- The product has been subjected to improper maintenance, abuse, misuse, excessive use of chemicals, accidents, or other damages, etc.

Swiss Madison® makes no implication that its products comply with any local building or plumbing codes. It is the consumer's responsibility and obligation to determine local code compliance prior to and during installation. This warranty extends only to the original purchaser and first consumer.

Swiss Madison® is not responsible for any special, incidental or consequential damages associated with the installation, replacement, return or use of the original purchaser's product. This includes, but is not limited to: freight costs, labor, travel time, lost profit, home damages and other contingent liabilities and costs (including, without limitation, costs associated with 'professionals' or 'experts', investigations, audits, analyses, attorneys and any other professional/hired services).

The Swiss Madison® warranty is a comprehensive and explicit limit of liability. All items not disclosed within the warranty are not addressable within the responsibility of Swiss Madison®. Certain states have variances regarding implied warranties; in those situations, we remain fully compliant.

QUESTIONS OR CONCERNS?

Please contact us directly at 1-434-MADISON (623-4766)



WARNING:

Contents of your order may contain sharp and possibly other harmful pieces and may cause hazard to children and adults. Swiss Madison® is not responsible in any way for personal damages.