

Assembly Instructions





B3907-110 SUNSTONE 6/6-6/0 EK/WK PANEL HEADBOARD
B3907-120 SUNSTONE 6/6-6/0 EK/WK PANEL FOOTBOARD & SLATS
B3907-330 SUNSTONE 5/0-6/6 EK/Q PANEL SIDE RAILS

Thank you for purchasing this quality product. Be sure to check all packing materials carefully for small parts, which may have come loose inside the carton during shipment. Identify and count all items and compare with the PARTS LIST and/or HARDWARE LIST shown below.



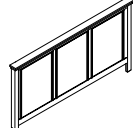
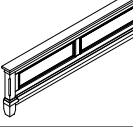
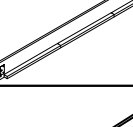
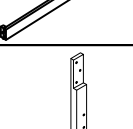
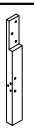

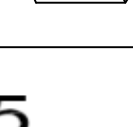
Caution: Please read the instructions thoroughly before assembly.

1. We recommend that you assemble this product with the assistance of another person: this will make the assembly easier, and will help eliminate damage to the product or injury to person during assembly.
2. Please do not over tighten screws or bolts until the assembly is completed.
3. Please put all parts on a non-abrasive floor before assembly, and follow the assembly steps to assemble your newly purchased product correctly and efficiently.

PARTS LIST

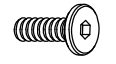
NO:	COMPONENT	ADRAWING	Q'TY
A	Headboard		1 PC
B	Footboard		1 PC
C	Side Rails		2 PCS
D	Headboard Crossbar		1 PC
E	Left Side Facing (LSF) HB Leg		1 PC
F	Right Side Facing (RSF) HB Leg		1 PC
G	Slats		5 PCS
H	Support Legs		10 PCS

HARDWARE LIST

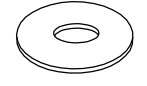
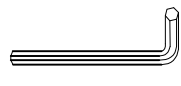
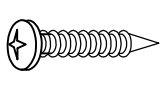
NO:	COMPONENT	ADRAWING	Q'TY
1	Bolt Ø5/16"x3/4"		8 PCS
2	Bolt Ø5/16"x1-3/8"		4 PCS
3	Bolt Ø5/16"x2"		6 PCS
4	Lock Washer Ø5/16"		18 PCS
5	Flat Washer Ø5/16"x3/4"		18 PCS
6	Allen Key 3/16"		1 PC
7	Screw #8*1-1/4"		10 PCS

Weight Capacity	800 LBS
-----------------	---------

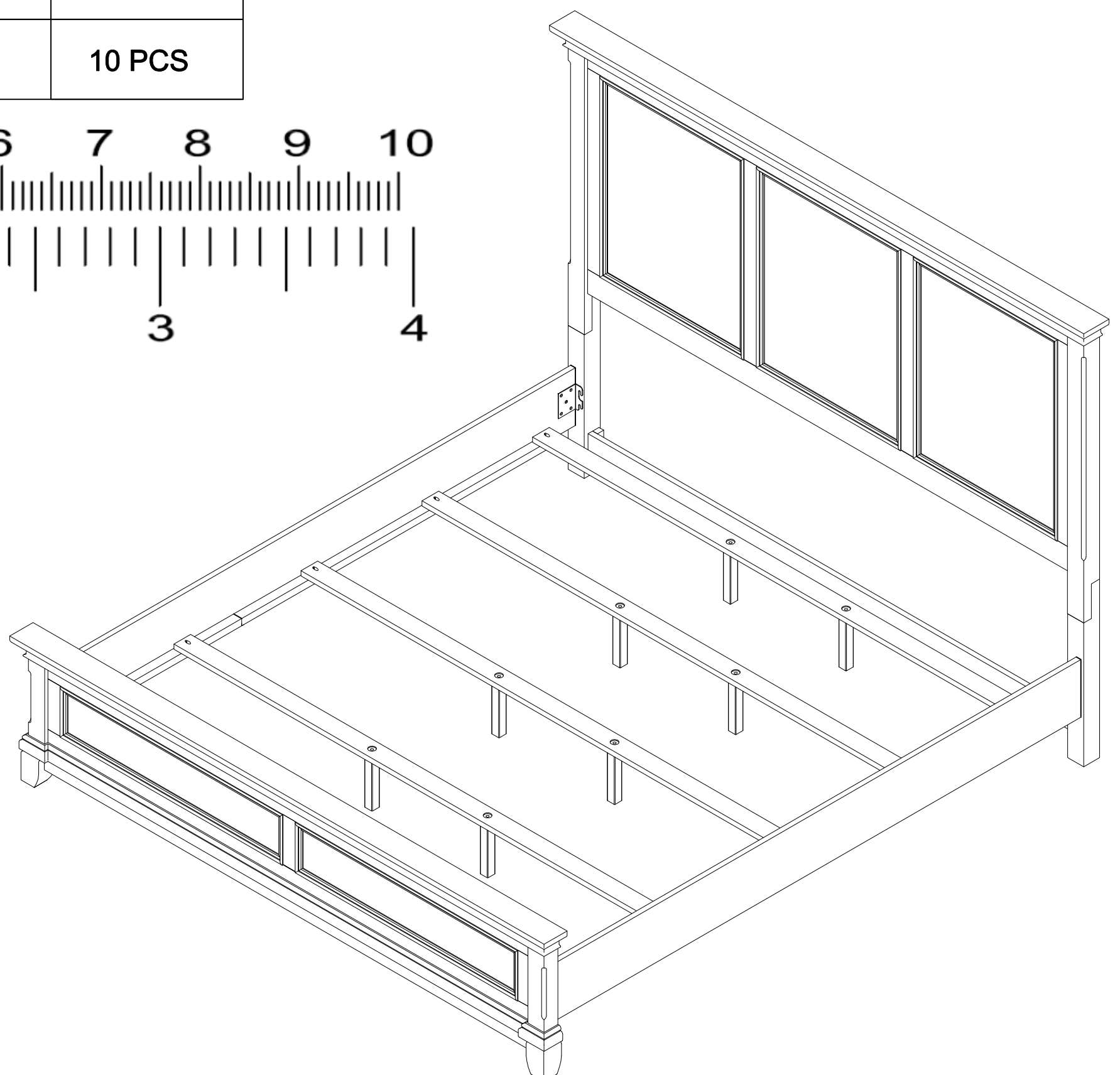
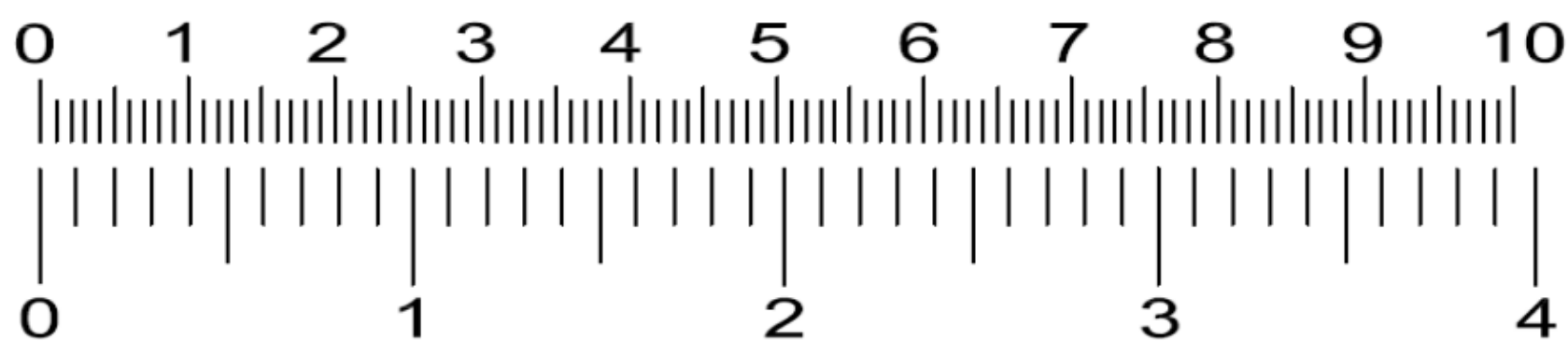

Assembly Instructions

B3907-110 SUNSTONE 6/6-6/0 EK/WK PANEL HEADBOARD
 B3907-120 SUNSTONE 6/6-6/0 EK/WK PANEL FOOTBOARD & SLATS
 B3907-330 SUNSTONE 5/0-6/6 EK/Q PANEL SIDE RAILS

STEP 1

Assemble LSF HB Leg (E) and RSF HB Leg (F) to Headboard (A) by using Allen Key (6) with hardware 3,4, and 5.
 Attn: DO NOT TIGHEN THE BOLTS

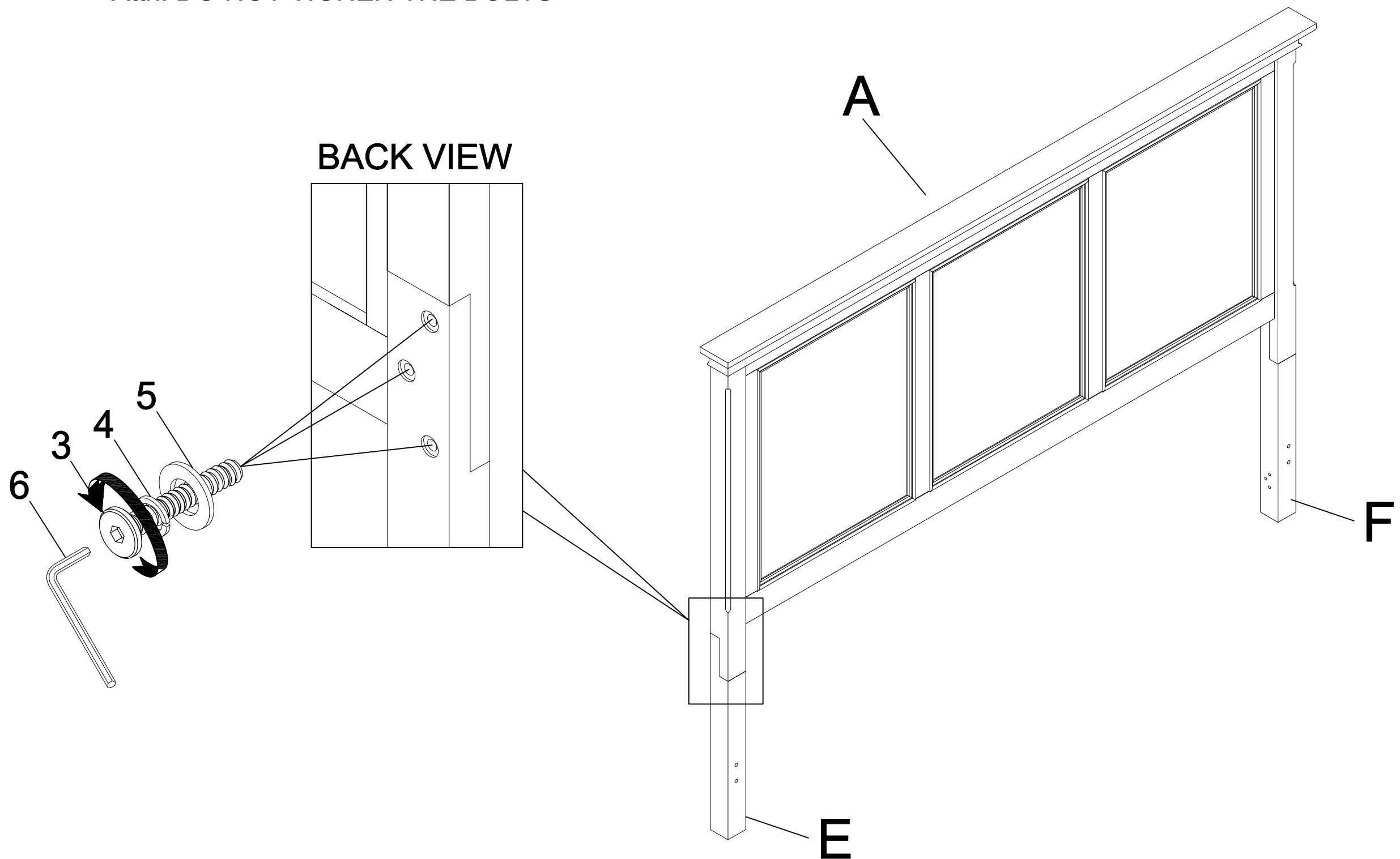

STEP 2

Assemble Headboard Crossbar (D) to HB legs (E) and (F) by using Allen Key (4) with hardware 2, 4, and 5.

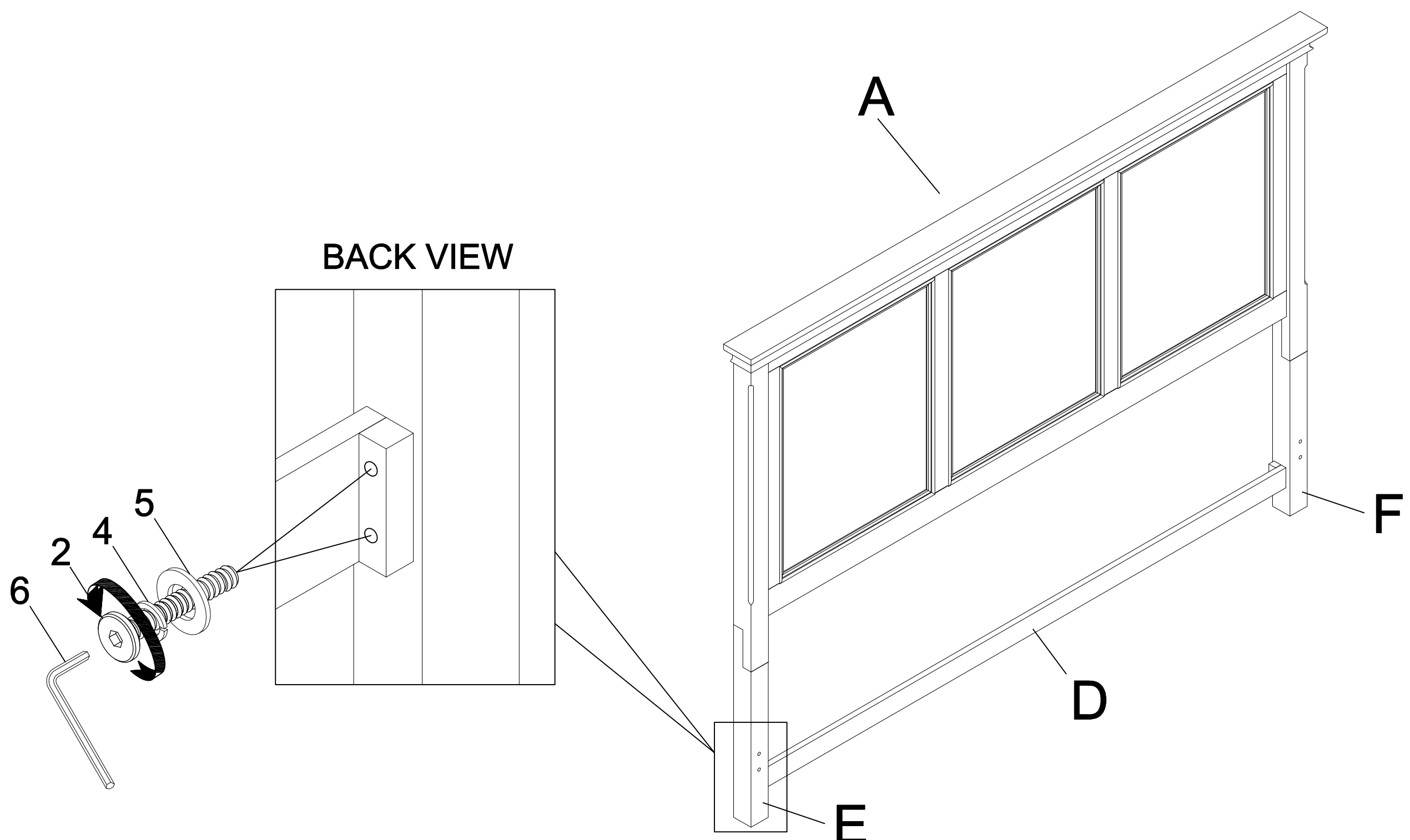

Assembly Instructions

B3907-110 SUNSTONE 6/6-6/0 EK/WK PANEL HEADBOARD
 B3907-120 SUNSTONE 6/6-6/0 EK/WK PANEL FOOTBOARD & SLATS
 B3907-330 SUNSTONE 5/0-6/6 EK/Q PANEL SIDE RAILS

STEP 3 Assemble Side rails (C) to HB legs (E & F) and Footboard (B) by using Allen Key (6) with hardware 1, 4, and 5.

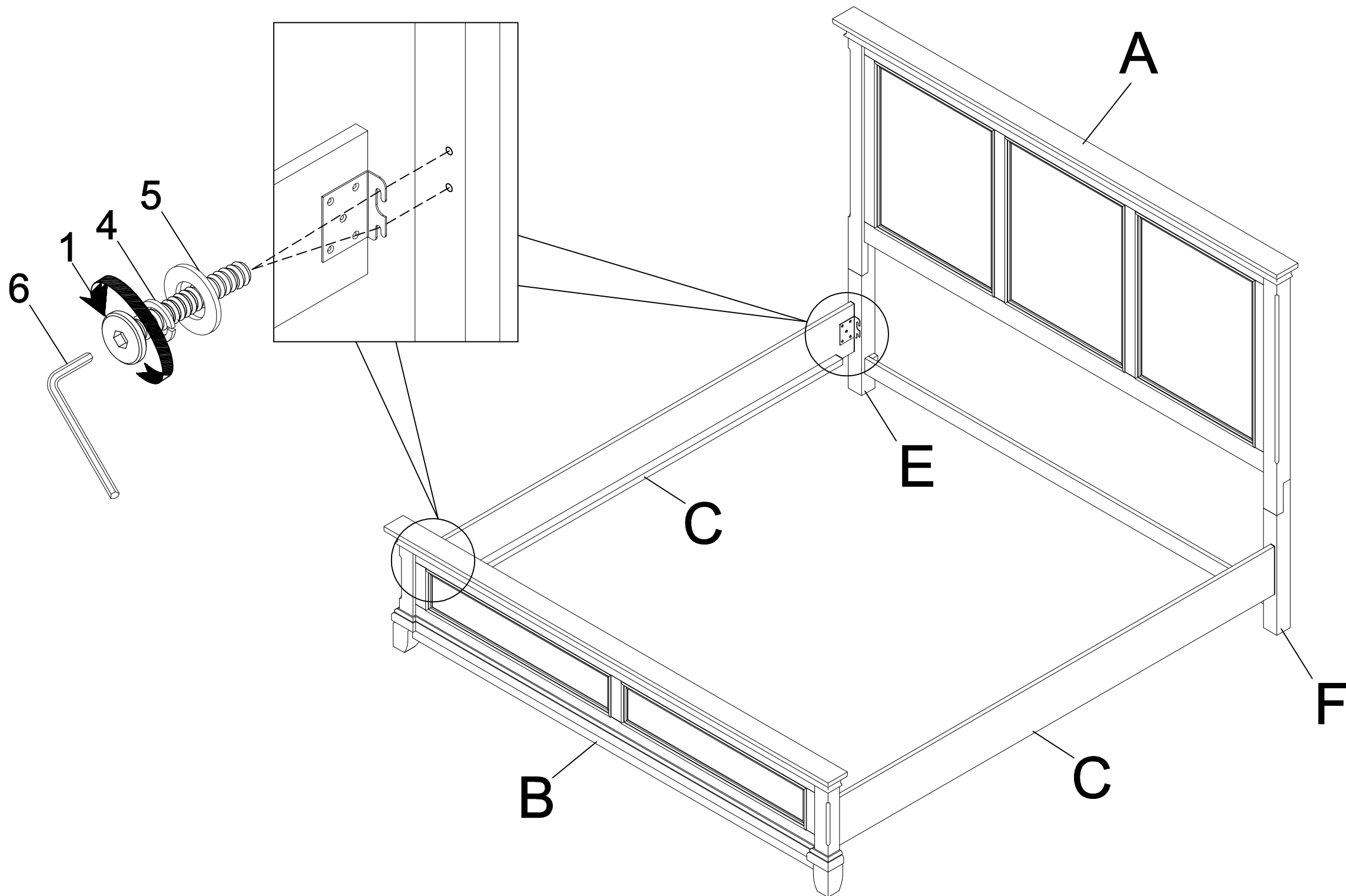

STEP 4 Assemble the Support legs (H) by twisting them on the Slat (G). Then adjust the leveler on the support legs (H) to level with the floor.

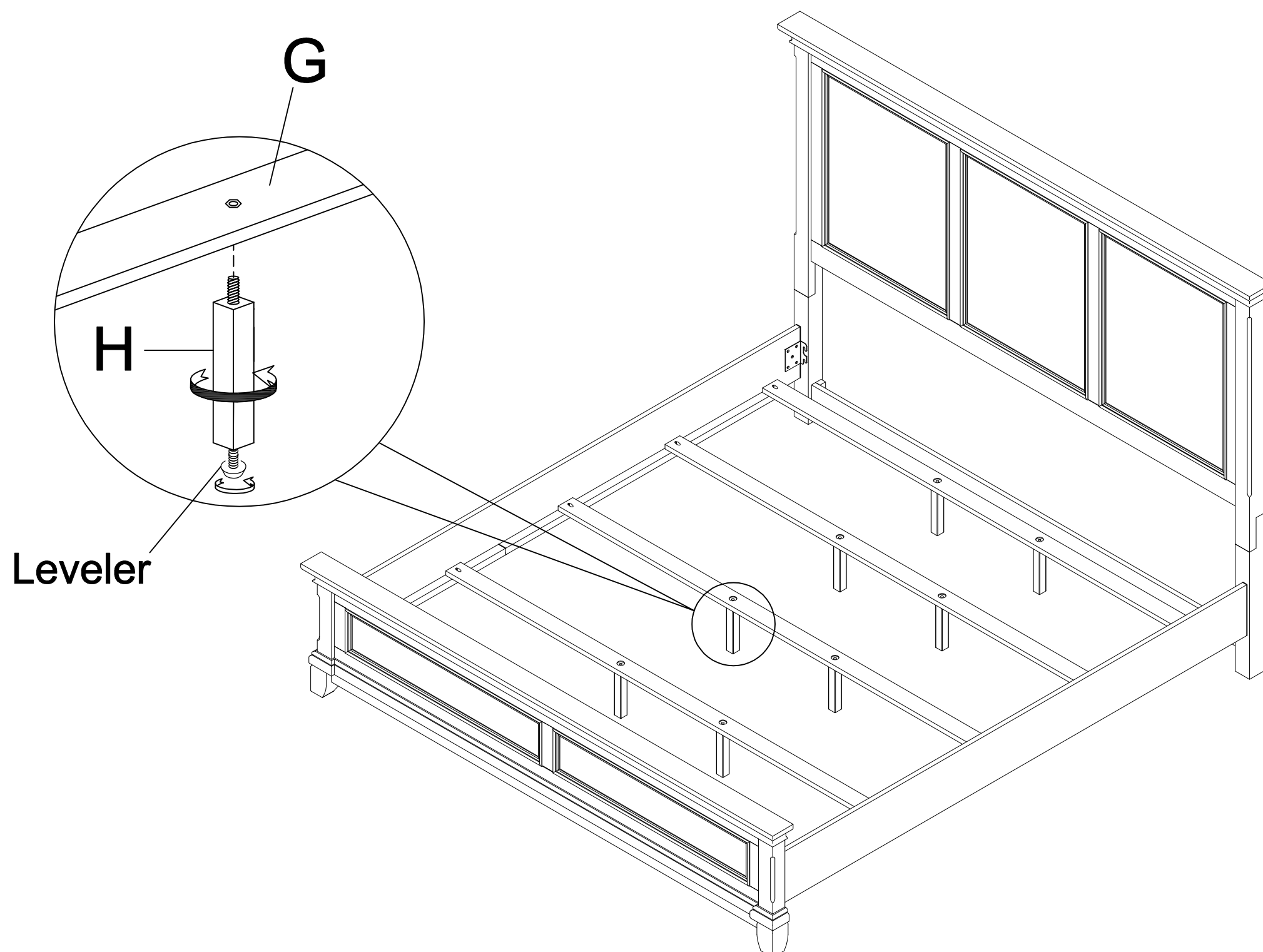

Assembly Instructions

B3907-110 SUNSTONE 6/6-6/0 EK/WK PANEL HEADBOARD
B3907-120 SUNSTONE 6/6-6/0 EK/WK PANEL FOOTBOARD & SLATS
B3907-330 SUNSTONE 5/0-6/6 EK/Q PANEL SIDE RAILS

STEP 5 Assemble the slat (G) to the side rails (C) by using a screwdriver with hardware 7.

