

**PRODUCT SPECIFICATIONS**

Stainless Steel 16-3/4" x 15-1/2" x 13" Single Bowl Wall Hung Handwash Sink. Sink is manufactured from 20 gauge 304 Stainless Steel with a Buffed Satin finish, Center drain placement.

<b>Material:</b>	304 Stainless Steel
<b>Finish:</b>	Buffed Satin
<b>Gauge:</b>	20
<b>Weight Without Packaging:</b>	10
<b>Number of Bowls:</b>	1
<b>Sink Dimensions:</b>	17" x 15-1/2" x 14"
<b>Bowl 1 Dimensions:</b>	13-5/8" x 9-3/8" x 5-3/4"
<b>Drainboard Location:</b>	No drainboard
<b>Backsplash Height:</b>	7.625
<b>Drain Size:</b>	2" (51mm)
<b>Drain Location:</b>	Center



A Century of Tradition and Quality.

For more than 100 years, Elkay has been making innovative products and providing exceptional customer care. We take pride in offering plumbing products that make life easier, inspire change and leave the world a better place.

**Product Compliance:** ASME A112.19.3/CSA B45.4  
NSF 2



[Clean and Care Manual \(PDF\)](#)

[Installation Instructions \(PDF\) - 200000714](#)

[Warranty \(PDF\)](#)

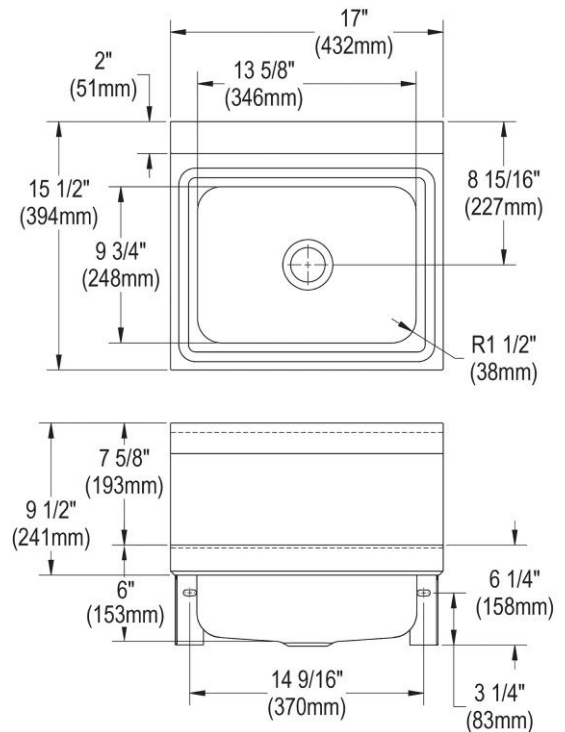

PART: \_\_\_\_\_ QTY: \_\_\_\_\_

PROJECT: \_\_\_\_\_

CONTACT: \_\_\_\_\_

DATE: \_\_\_\_\_

NOTES: \_\_\_\_\_

APPROVAL: \_\_\_\_\_

*In keeping with our policy of continuing product improvement, Elkay reserves the right to change product specifications without notice. Please visit [elkay.com](http://elkay.com) for the most current version of Elkay product specification sheets. This specification describes an Elkay product with design, quality, and functional benefits to the user. When making a comparison of other producers' offerings, be certain these features are not overlooked.*

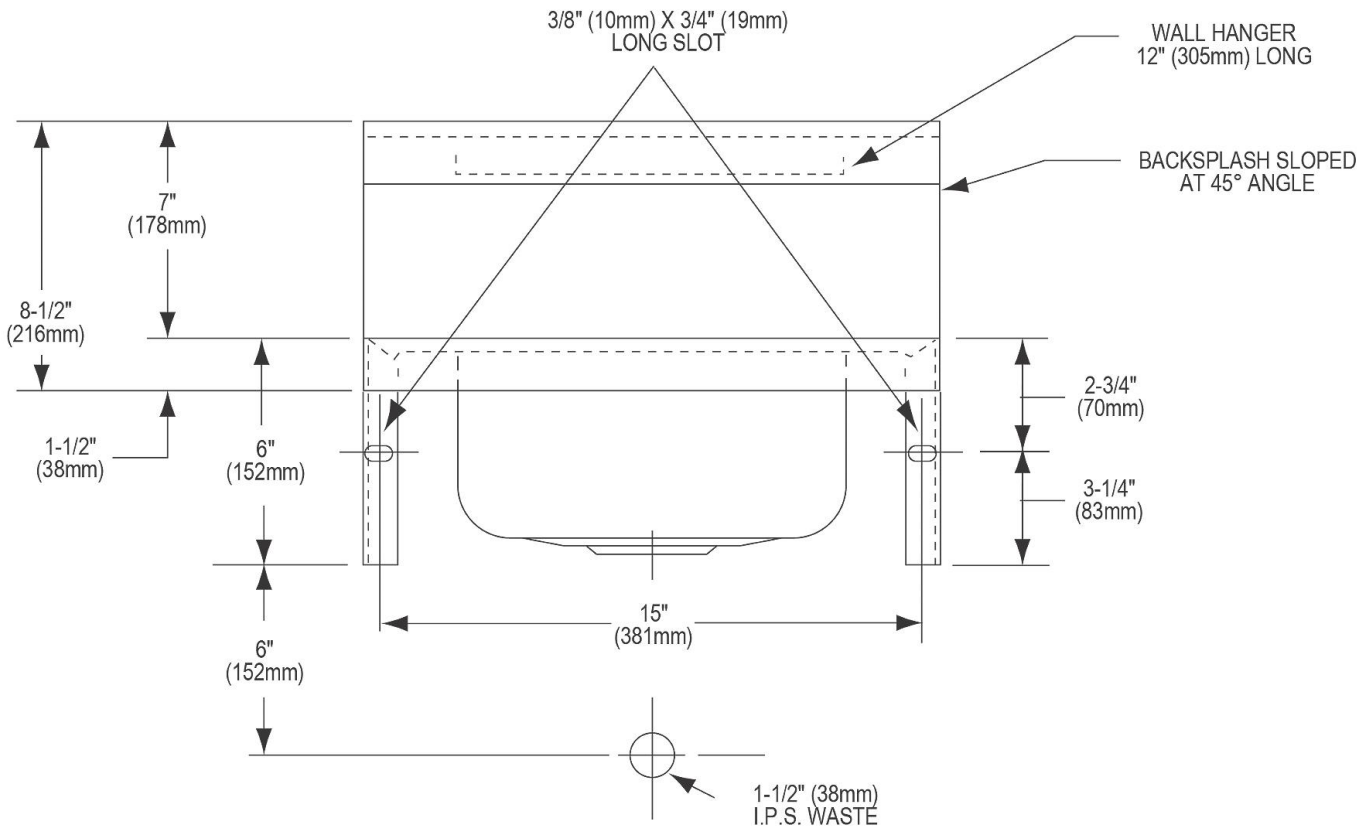

*In keeping with our policy of continuing product improvement, Elkay reserves the right to change product specifications without notice. Please visit [elkay.com](http://elkay.com) for the most current version of Elkay product specification sheets. This specification describes an Elkay product with design, quality, and functional benefits to the user. When making a comparison of other producers' offerings, be certain these features are not overlooked.*