

# Faucet Installation Instructions

# ANZZI™

**L-AZ181BN  
L-AZ181ORB**

**SINGLE HOLE LAVATORY FAUCET  
SOLID BRASS  
CERAMIC CARTRIDGE  
FLOW RATE:1.2GPM  
LIMITED LIFETIME WARRANTY:**

**HAVE QUESTIONS?**

Call us at 1-844-44-ANZZI or visit [www.ANZZI.com](http://www.ANZZI.com)

## PREPARATION

**MAKE SURE TO SHUT OFF THE WATER FLOW  
FROM YOUR HOT AND COLD SUPPLY LINES.**

**MAKE SURE YOUR MOUNTING HOLE IS CUT TO  
SIZE.**

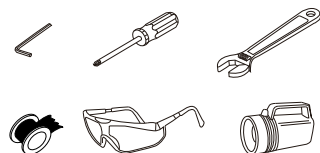

**ITEMS YOU MAY NEED.**

**NEED HELP? Give us a call at 1-844-44-ANZZI or  
visit us online at [www.ANZZI.com](http://www.ANZZI.com).**

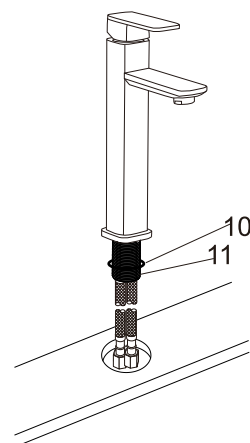
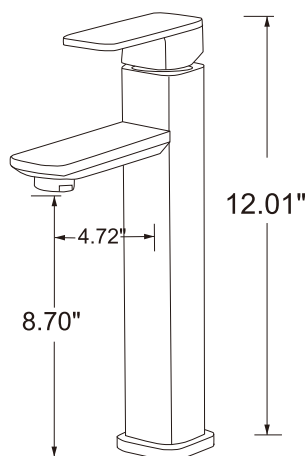
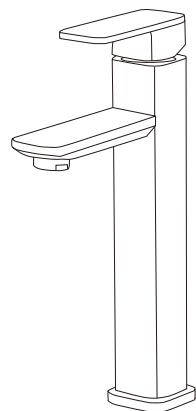

## STEP 1

Place O-ring (10) onto the pipe (11) before lowering the pipe through the mounting hole.

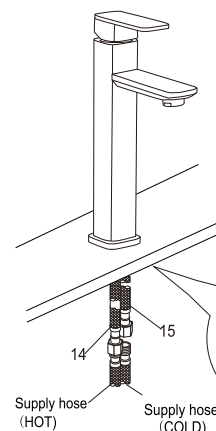
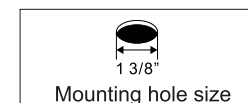

## STEP 2

Fix the lock nut (13), metal washer (18) and rubber washer (12) onto the pipe. Tighten the screws (19) to secure. Do not overtighten.

## STEP 3

Attach your hot and cold supply lines to the faucet.

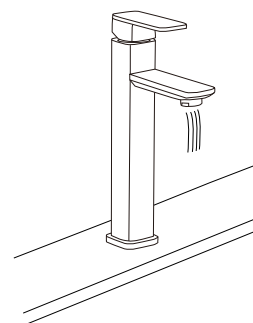

## STEP 4

Open the hot and cold supply lines. Take this time to check for leaks. Turn the faucet handle for one and allow the water to flow for one minute to remove any debris from the faucet's interior.

**ENJOY!**