

# 88 5760 104

## The Orleans 6 Tier Shelf

### IMPORTANT NOTE

Carefully remove all the parts from the carton and put them individually on a soft cloth to prevent scratches or other damages occurring to the parts.

We have taken great care in the design of this product and request that you carefully and strictly follow our assembly instructions to ensure a completed product as it was designed.

*Home Styles*

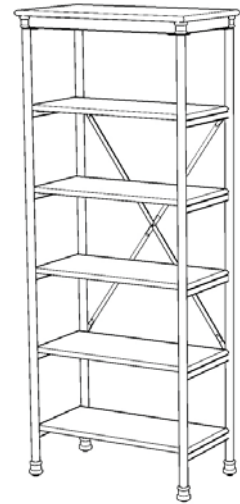

### Part List



**A.**  
**Top**  
1 pc.

**B.**  
**Side Frame**  
1 pc.

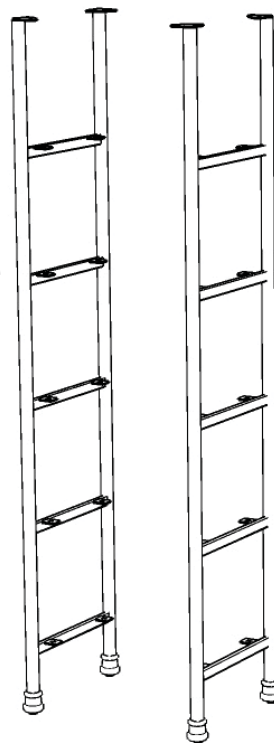

**C.**  
**Side Frame**  
1 pc.

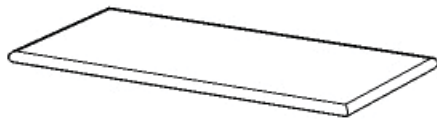

**D.**  
**Shelf**  
5 pcs.

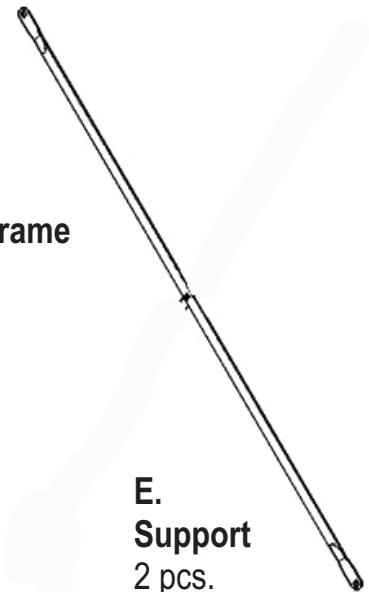

**E.**  
**Support**  
2 pcs.

### Hardware List



**Hex Wrench**  
1 pc.



**Flat Washer**  
24 pcs. (+1 extra)



**Head Cap Bolt**  
24 pcs. (+1 extra)



**Cap Nut**  
1 pc. (+1 extra)



**Small Hex Wrench**  
1 pc.



**Spring Washer**  
24 pcs. (+1 extra)



**Head Cap Bolt (short)**  
8 pcs. (+1 extra)



**Head Cap Bolt (for support)**  
1 pc. (+1 extra)

**Tools required for assembly :** Phillips screwdriver

**Tools recommended for assembly :** Level

**Home Styles Consumer Assistance:** [www.homestyles-furniture.com](http://www.homestyles-furniture.com),  
[servicedesk@homestyles-furniture.com](mailto:servicedesk@homestyles-furniture.com), 888-680-7460, 877-831-0319

# Assembly Instructions 2/2

## IMPORTANT

- \* Do not tighten up all the screws until each part is properly assembled.
- \* You should keep Hex Wrench in a safe place as you may need to tighten up the Head Cap Bolts in the future.
- \* After assembly, item must be level to work properly. Use the included adjustable levelers to level.

## STEP 1

Place Top (A) upside down on a soft cloth.

Attach Side Frame (B), (C) onto Top (A) with Head Cap Bolts (short). (See figure 1)

Assemble Supports (E) with Blot (for support) and Cap Nut. (See Figure 2)

Then attach to unit with Flat Washers, Spring Washers and Head Cap Bolts.

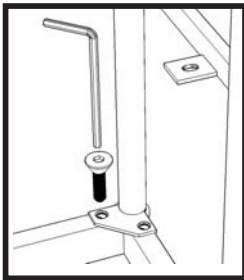

Figure 1

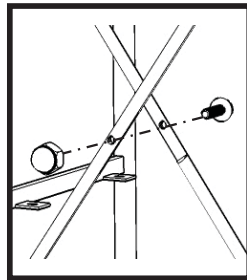
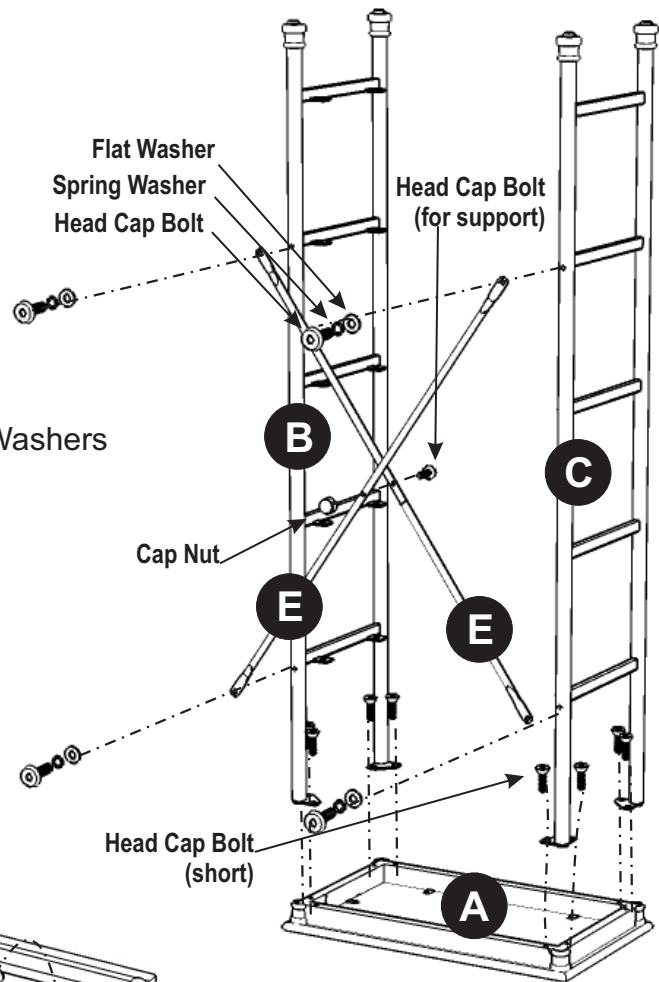

Figure 2



## STEP 2

Attach Shelves (D) to unit with Flat Washers, Spring Washers and Head Cap Bolts. (See Figure 3)

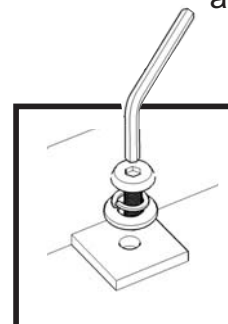

Figure 3

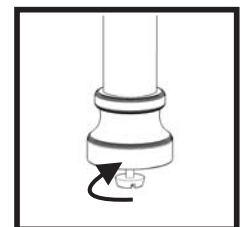

Figure 4

## STEP 3

Turn the unit over to its' upright position.

To level the unit, adjust the adjustable levelers on the bottom of unit. (See Figure 4)

**Note: Unit must be level to work properly.**

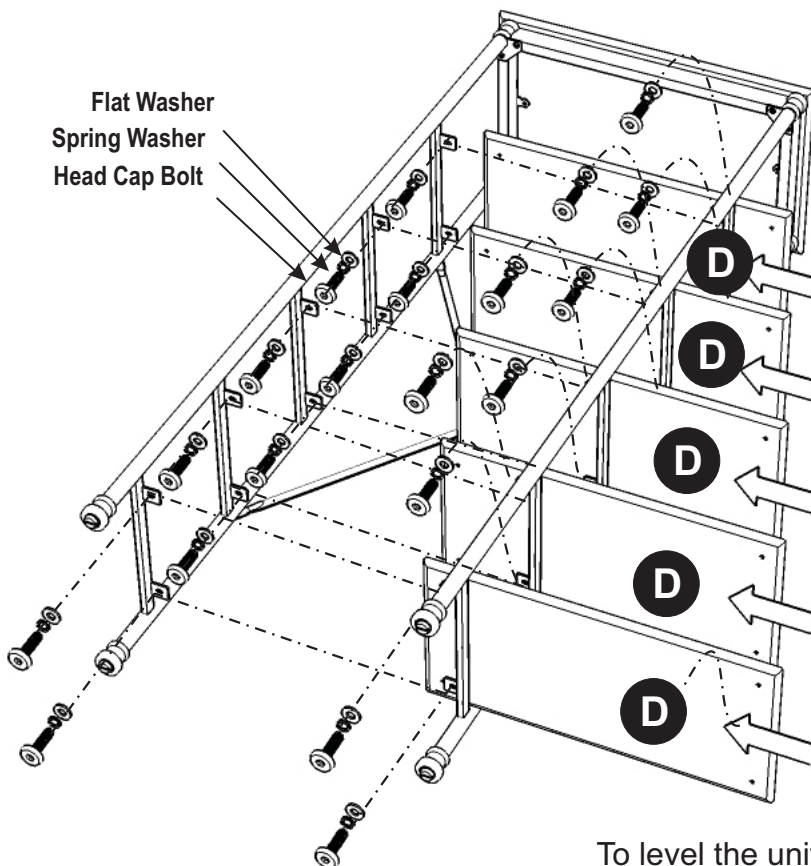

# Attention !

For safety reasons, we recommended you strictly follow these additional instructions to prevent the unit from tipping over.

## HARDWARE LIST

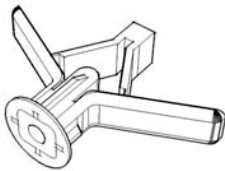

**Anchor**  
1 pc.(+1 extra)

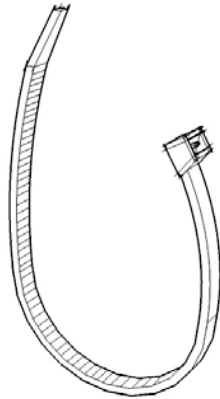

**Plastic Belt**  
1 pc.(+1 extra)

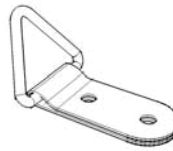

**Bracket**  
1 pc.(+1 extra)



**Wall Screw**  
1 pcs. (+1 extra)

## Assembly Instructions

Place the cabinet at desired location in room.

Drill a ¼" hole in wall at the appropriate location.

Insert the Anchor into the wall hole and attach the Bracket using the wall screw.

Use the Plastic Belt to secure the hole at the back of unit to the Bracket on the wall.

Put the tie end of the belt into the loop end of the belt and pull until tight.

