

Monaco Freestanding Bathtub

MON-N-SW-NO / MON-N-SW-OF

Top view

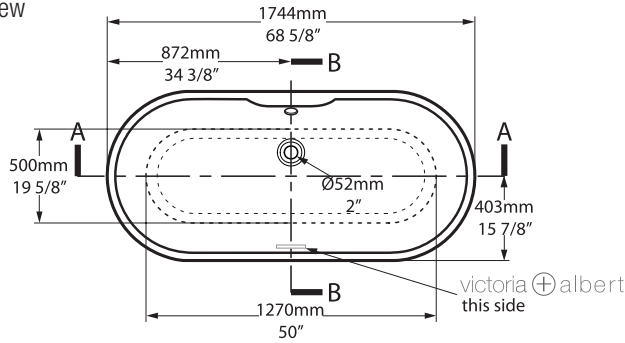

Front view

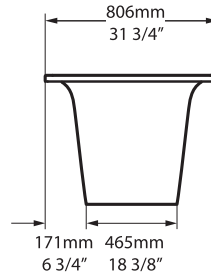

Section BB

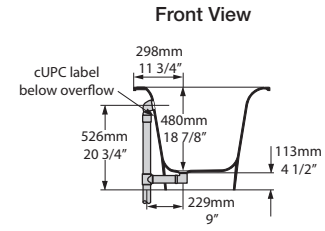

Side view

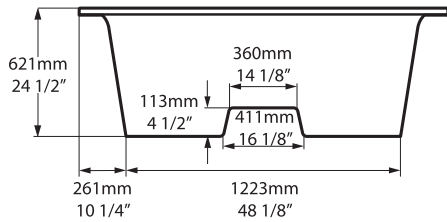

Rim detail

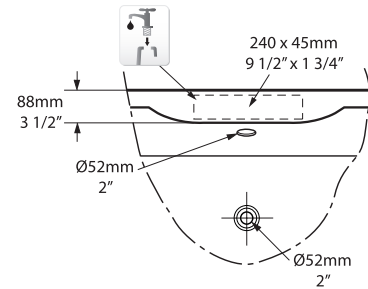
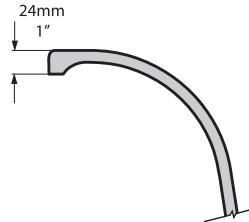

Section AA

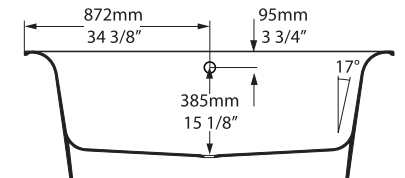

Faucet holes can be drilled by installer
Les trous de robinetterie peuvent être percés par l'installateur
Pueden ser perforados por el instalador

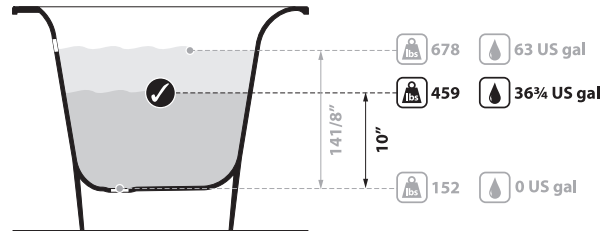

BV-21_0049

Recommended drains: K-40E-xx / K-70-xx / K-50-xx

Drain Void: Features a void space underneath the bathtub for drain plumbing.

Note: K-36E/K-40E drains must be installed using all tools and washers included; do not use plumbers putty or silicone in the place of washers provided

- All measurements subject to +/-5% tolerance
- NO = no overflow hole
- OF = overflow hole

25 years

25 year warranty for residential use (unpainted product)
Garantie de 25 ans pour un utilisation résidentiel (produit non peint)
Garantía de 25 años para uso doméstico (productos no pintados)

5 years

5 year warranty on drains
Garantie de 5 ans sur les drains
Garantía de 5 años para los drenajes

8 years

8 year warranty for commercial use (unpainted product)
Garantie de 8 ans pour un usage commercial (produit non peint)
Garantía de 8 años para uso comercial (productos no pintados)

2 years

2 year warranty on painted exterior
Pour les finitions extérieures peintes la garantie est de 2 ans
Acabados de pintura exterior tienen una garantía de 2 años



Massachusetts Code: Approved
cUPC listing by IAPMO: File No. 6574

