

6. Install electrical junction box at the marked location.
7. Place towel warmer on the wall, by inserting the mounting tubes over the support cores and attach using the set screws (E) tighten with an Allen wrench.
8. Make your electrical connection and install towel warmer on the wall, by inserting the mounting tubes over the support cores and attach using the set screws (E) tighten with an Allen wrench.
9. Fasten the cover plate (I) to the junction box using enclosed screws (B).

CAUTION - Overlapping towels may increase towel warmer temperatures.

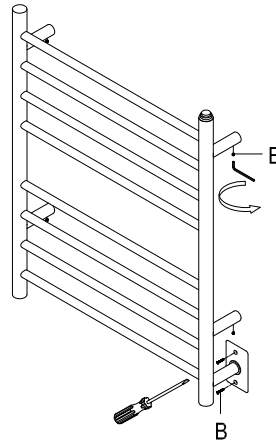
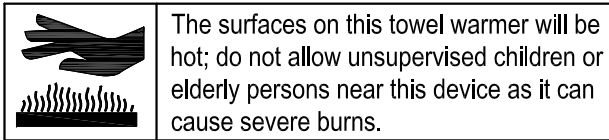
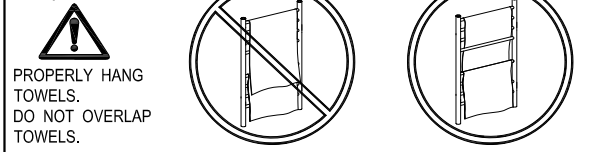

KINGSTON

KITCHEN & BATH

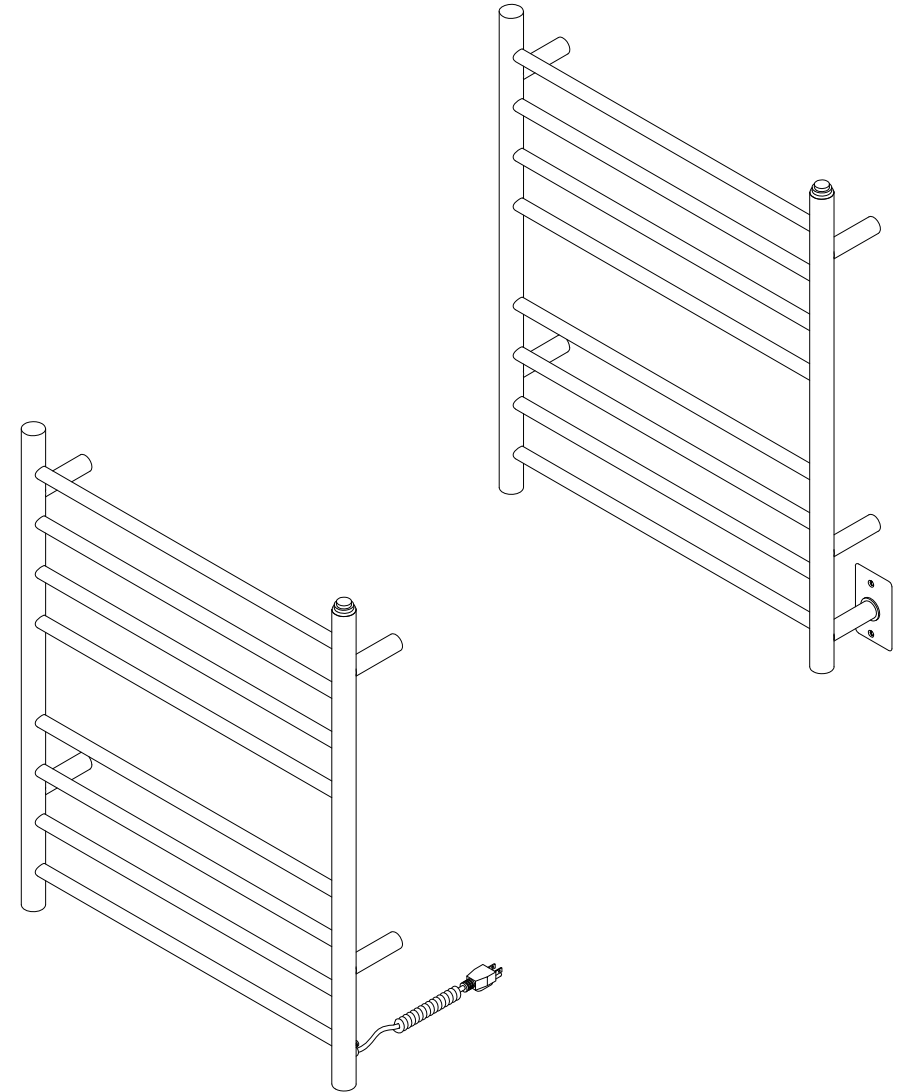

Operation and maintenance instruction

- Once the unit is plugged in, turn the unit on, a red indicator light will let you know it is warming.
- This unit is designed to run continuously.
- Turn off when you are done, the indicator light will turn off, letting you know it is no longer in warming mode.
- You may clean it with a soft dry towel.

Voltage:120VAC Rated Frequency: 60HZ-80W

Warning :

1. Do NOT connect the wire with power grid before read this entire installation instruction thoroughly.
2. Do NOT use any abrasive or chlorine-base cleaner on the towel warmer, use only soft and damp cloth to clean it if necessary.
3. NEVER place the towel warmer inside a shower, sauna or steam room or into the water for any reason.
4. NEVER operate the towel warmer if any damage on the wire or plug. Contact manufacturer, service agent or the similar qualified people in case of shock hazard.
5. Towel Warmer is NOT a toy. It will heat up and may appear hot to touch, switch off when not in use
6. In order to avoid a hazard for infant and children, NEVER allow infant or children to play on or nearby the towel warmer, close supervision is necessary.
7. Do NOT stand, sit, lean against or hang on the unit.
8. This product is only for textile fabrics that washed by water.
9. Anyone with defects in body, organ or mentally and inexperienced must use this appliance under the supervision or guide of professional people or qualified people.
10. If any quality problem when the product works, shut down the power right away and contact the service center or manufacturer. DO NOT DISASSEMBLE ITSELF IN CASE SHOCK HAZARD.
11. Always ensure your hand is dry when unplugging the power cord.
12. For Wall Mount installation, this appliance should be installed at the place that is at least 100cm (39.3") above the floor.

www.kingstonbrass.com

TOLL-FREE CUSTOMER SERVICE: 1-877-2-KBRASS
 TECHNICAL SUPPORT E-mail: service@kingstonbrass.com
 12775 Reservoir Street, Chino, CA 91710

KINGSTON

KITCHEN & BATH







INSTALLATION INSTRUCTIONS

Wall Mount & Hardwire Electric Towel Warmer

Before Installation:

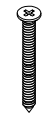
- Review Installation instructions carefully.
- This towel warmer requires 120VAC-60HZ, grounded power supply and should be protected by a dedicated 15 amp circuit breaker or equivalent.
- According to NEC and NFPA regulations all electrical work must be performed by a "Qualified" person.
- Please follow applicable construction codes and electrical wiring regulations, especially those pertaining to installation of electrical products in potentially damp areas.
- When selecting the location for the installation of this product, it is best to install in a location where it will be out of reach to unsupervised small children or subject to accidental contact by elderly or disabled persons.
- This product is designed for residential use exclusively and not intended to be installed inside a shower stall, steam room or submerged in water.
- Do not install this towel warmer on a wall over a tub.
- Do not let power supply cord come in contact with the towel warmer's surface.
- Carefully open package to avoid damage or loss of any parts, inspect contents and confirm that all components are included, do not attempt to assemble unless you have all the parts shown on image.
- If you suspect any possible malfunction please unplug or shut off any power supply to this unit immediately and contact the manufacturer.

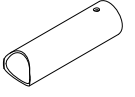
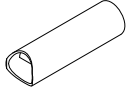
Parts:

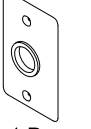
Allen Screw	Screw		Anchor	Set Screw
A M8 x 15	B Ø3.2 x 17.5	C ST4.2 x 40	D	E M5 x 5
				
4 Pcs	2 Pcs	4 Pcs	4 Pcs	4 Pcs
Mounting Tube	Cover Tube	Support Core	Cover Plate	
F	G	H	I	
				
4 Pcs	1 Pc	4 Pcs	1 Pc	

Assembly and installation Instructions

For Plug-in models:

1. After putting a blanket on the floor place towel warmer rack face down on top of the blanket.
2. Attach the 4 mounting tubes (F) to the back of the rack by inserting the Allen screws (A) and secure using an Allen wrench.
3. Place towel rack at the desired location, with a pencil, mark the location of the 4 mounting tubes (F) on the wall and insert the appropriate anchors (D) for your type of wall and secure the support cores (H) to the wall using enclosed screws (C).
4. Place towel warmer on the wall, by inserting the mounting tubes over the support cores and attach using the set screws (E) tighten with an Allen wrench.
5. For plug in models, just plug into a dedicated outlet.

Need Tools:

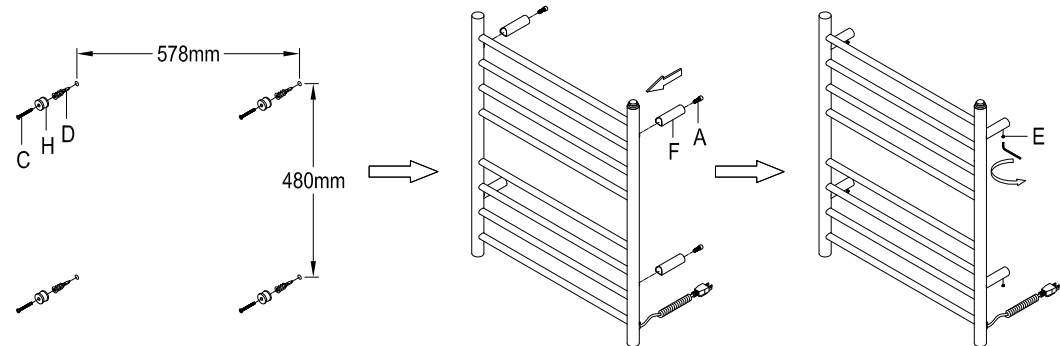
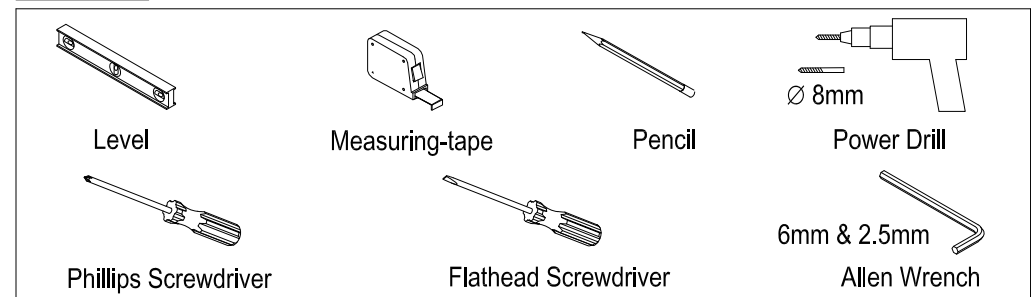

For Hardwire models:

1. After putting a blanket on the floor place towel warmer rack face down on top of the blanket.
2. Attach the 4 mounting tubes (F) to the back of the rack by inserting the Allen screws (A) and securing using an Allen wrench.
3. Remove the set screw located at the point where the cable attaches to the towel warmer and cut the cable at 10" from the towel warmer rack.

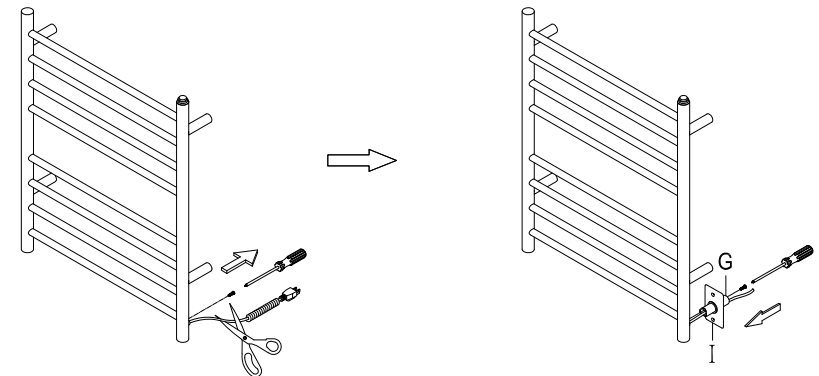

4. Feed cable through the cover tube (G) and attach tube to the frame using the screw that had been previously removed, slip the junction box cover plate (I) over the cover tube (G).
5. Place towel rack at the desired location, with a pencil, mark the location of the 4 mounting tubes (F) as well as the location of the electrical junction insert the appropriate anchors for your type of wall and secure the support cores (H) to the wall using enclosed screws (C).