

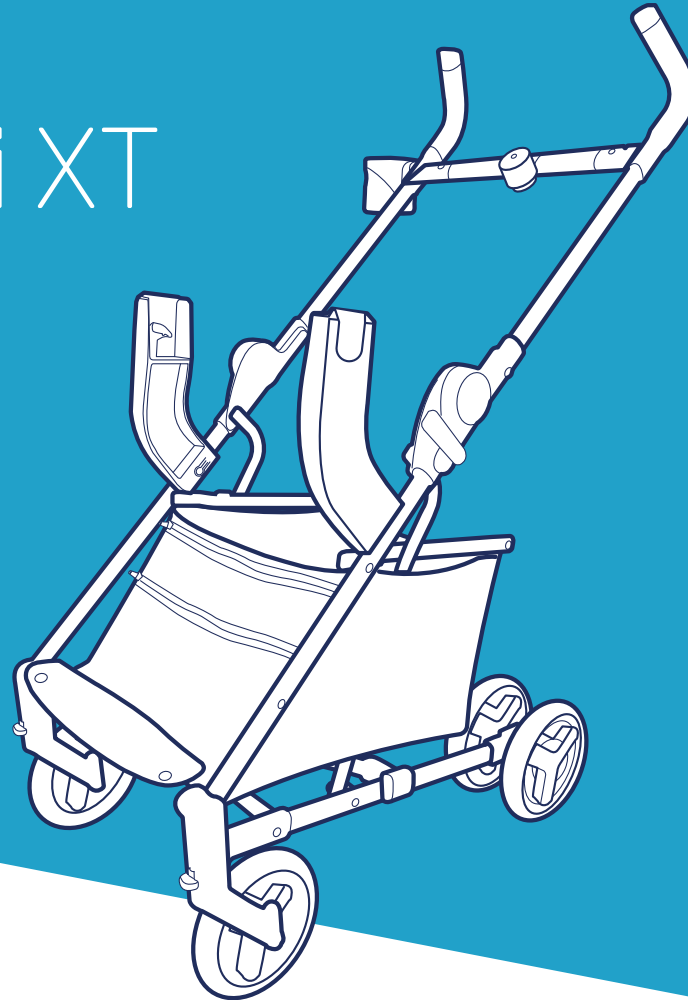

Maxi-Taxi XT

Ultra Compact
Car Seat Caddy



MAXI-COSI® 4358-8161B 5.3.21

We carry the future

KEEP INSTRUCTIONS FOR FUTURE USE.
Read all instructions before using this stroller.

Safety Information

WARNING:

FOR THE SAFETY OF YOUR CHILD, PLEASE READ THE FOLLOWING WARNINGS AND INSTRUCTIONS AND KEEP FOR FUTURE REFERENCE.

- Adult assembly required.
- **NEVER LEAVE CHILD UNATTENDED. ALWAYS** keep child in view when in stroller.
- **AVOID SERIOUS INJURY** from falling or sliding out. **ALWAYS** use infant car seat restraint system. Check frequently to make sure it is secure. Reference Infant Car Seat Instruction Manual for Restraint System Usage. Failure to follow these instructions could result in the serious injury or death of your child.
- **ALWAYS** keep fingers away from moving parts, when folding, unfolding or adjusting stroller to prevent finger entrapment.
- **ALWAYS** make sure stroller is fully open and locked before using.
- **ALWAYS** use the brakes when stroller is stopped.
- **ALWAYS** remove protective material and poly bags and dispose before assembly.
- **NEVER** put hot liquids in the cup holder.
- **NEVER** use stroller on stairs or escalators.
- **NEVER** rollerblade with stroller.

- **NEVER** allow children to play with or hang onto the stroller.
- **NEVER** allow children to climb into the stroller unassisted. Stroller may tip over and injure child.
- **NEVER** place or hang parcels, bags, or accessories on the handle or canopy. The stroller may tip over or the canopy may collapse.
- This product will become unstable if a parcel bag or rack is used when there is no provision for one.
- This product may become unstable if a parcel bag, other than the one recommended by the manufacturer is used.
- This product will become unstable if the manufacturer's recommended load is exceeded.
- Care must be taken when folding and unfolding the stroller to prevent finger entrapment.
- **DO NOT** carry additional children, goods, or accessories in or on this product except as recommended in the manufacturer's instructions.
- **NEVER** place more than 2 lbs (.9 kg) in the cup holder.
- **NEVER** place more than 10 lb (4.5 kg) in the storage basket. If weight is exceeded, hazardous unstable conditions may exist.
- **STROLLER** is only for use with children within the car seat manufacturer's recommended maximum weight limit and when seated the top of the child's head is 1" below the top of the infant car seat. Please refer to the manufacturer's instructions for the use of your infant car seat.
- **ONLY** use this stroller with **ONE** child at a time.
- Failure to follow the steps and warnings on the labels and in the instruction manual can result in serious injury or death to your child.

Contents

Parts of Stroller	2	Storage Basket Use	8
Installing & Removing Front Wheels	3	Folding Stroller	9
Unfolding Stroller Frame	4	Accessory Use & Care	10
Using Parking Brake & Locking Swivel Wheels	5	Wash & Care of Stroller Parts	11
Attaching Car Seat to Stroller Frame	6	Dorel Juvenile Group Information	12
Removing Car Seat from Stroller Frame	7	Replacement Parts	12
		Warranty	12

Parts of Stroller

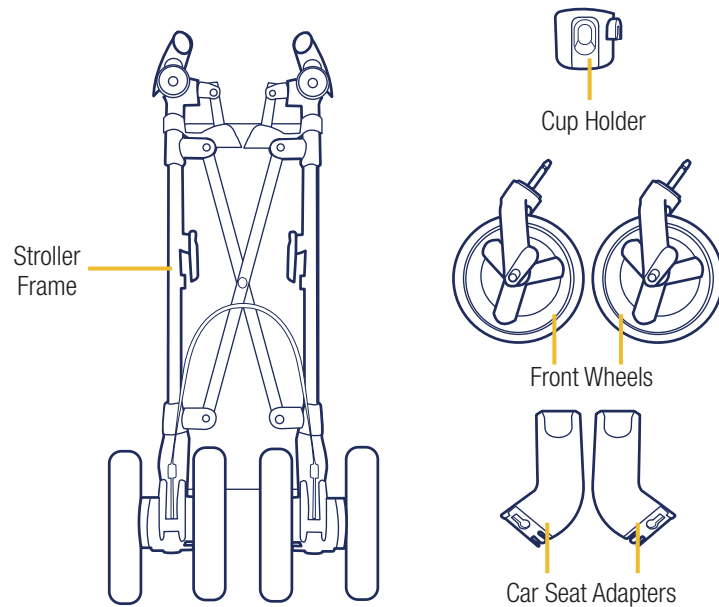

Lay out and identify all of the parts.

If any parts are missing, **do not return this product to the place of purchase.**

Please contact Consumer Care via:

- Phone: 1-800-951-4113
- Text: 1-812-652-2525
- Chat: www.maxicosi.com

You will need to know the model number and manufacture date.

It is located on a label on the stroller frame.

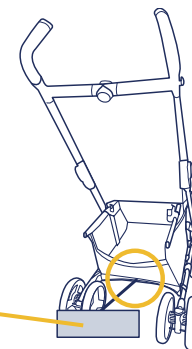

Installing & Removing Front Wheels

Installing Front Wheels

1

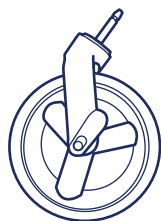

Attach the front wheels as shown.

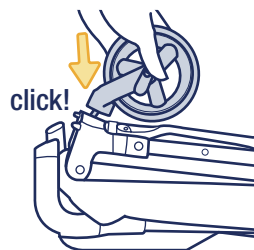

2

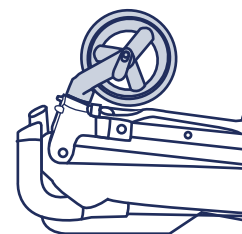

Finished!

NOTE: Pull out on the wheels to make sure they are secured.

Removing Front Wheels

1

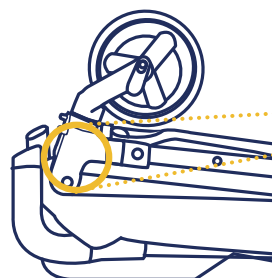

Press the release button on the stroller frame and hold it in.

Inside of leg frame

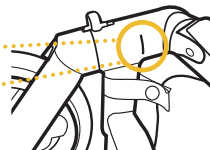

2

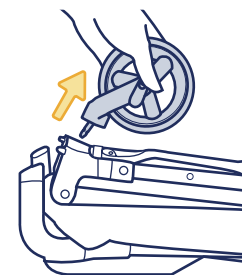

Remove the front wheels.

Unfolding Stroller Frame

Stroller Frame Latch

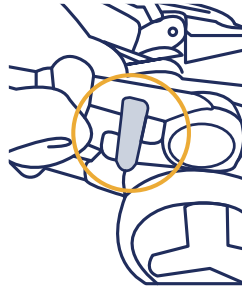

1



Push in on the stroller frame and then pull the stroller frame latch away from the stroller.

2

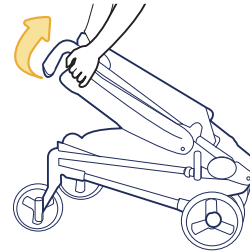

Hold the stroller frame as shown and lift up.

3



Continue to lift up and then push the crossbar forward until the stroller locks into place.

4

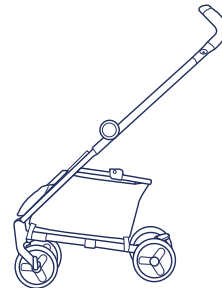

Finished!

⚠ WARNING:
ALWAYS keep fingers away from moving parts, when folding, unfolding, or adjusting stroller to prevent finger entrapment.

Using Parking Brake & Locking Swivel Wheels

Rear Wheels

Parking Brake
(locks both rear wheels)

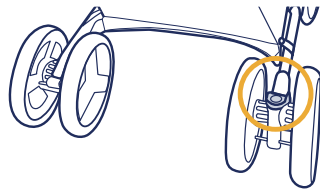

To Lock Parking Brake
Push down.

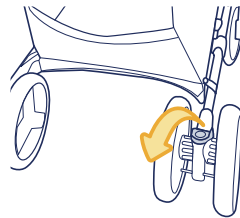

To Release Parking Brake
Lift up.

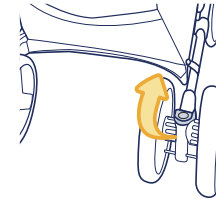

Front Wheels

Front Swivel Wheels

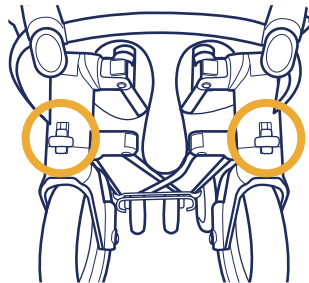

To Lock Swivel Wheels

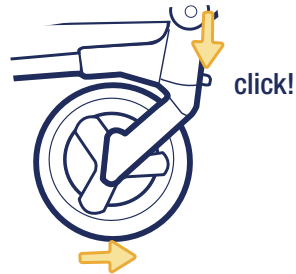

- The wheels must face forward as shown.
- Firmly push the lock tab down.
- Locked swivel wheels are best for traveling over rocky or uneven surfaces.

To Unlock Swivel Wheels



- Firmly pull the lock tab up.
- Unlocked swivel wheels are best for everyday strolling.

Attaching Car Seat to Stroller Frame

Illustrations show a generic car seat icon.

1

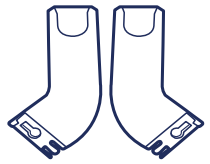

Car Seat Adapters

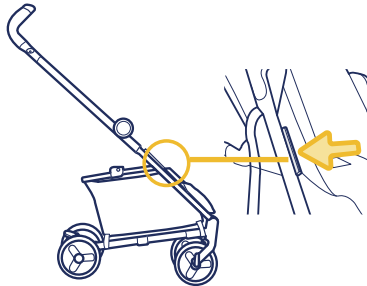

Locate the car seat adapter attachments on the stroller frame.

2



Match the colored dots on the adapters with the colored dots on the attachments.

Slide the car seat adapters onto the attachments.

2



Attach the car seat to the car seat adapters.
ONLY install the car seat facing the stroller handle.

3



Pull up on the car seat either at the carry handle or handle hubs to check if it is securely attached.

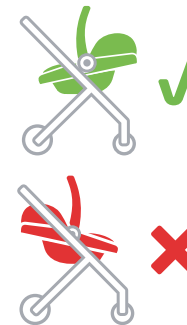

Removing Car Seat from Stroller Frame

Illustrations show a generic car seat icon.



Mico Models'
Stroller Release Buttons



Coral Models'
Stroller Release Lever

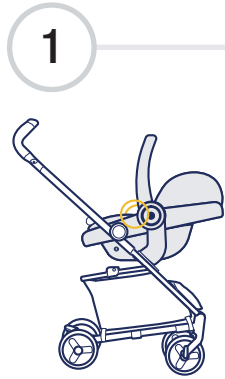

Car seat stroller release mechanisms & locations vary by car seat model.

Review your car seat's instruction manual to locate the stroller release mechanism on your car seat.



While engaging your car seat's stroller release mechanism, lift the car seat off the stroller frame.

Removing Car Seat Adapters

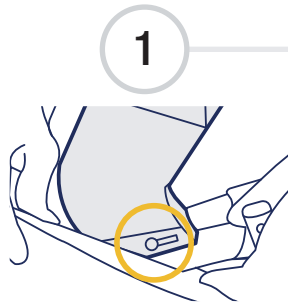

Press the release buttons on the car seat adapters.

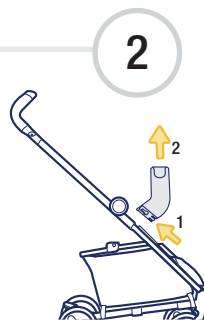

Slide the car seat adapters off of the attachments.

7

⚠ CAUTION:

- You may fold the stroller with the adapters still attached when storing the stroller.
- Before putting the folded stroller into a vehicle, the adapters **MUST** be removed.

Storage Basket Use

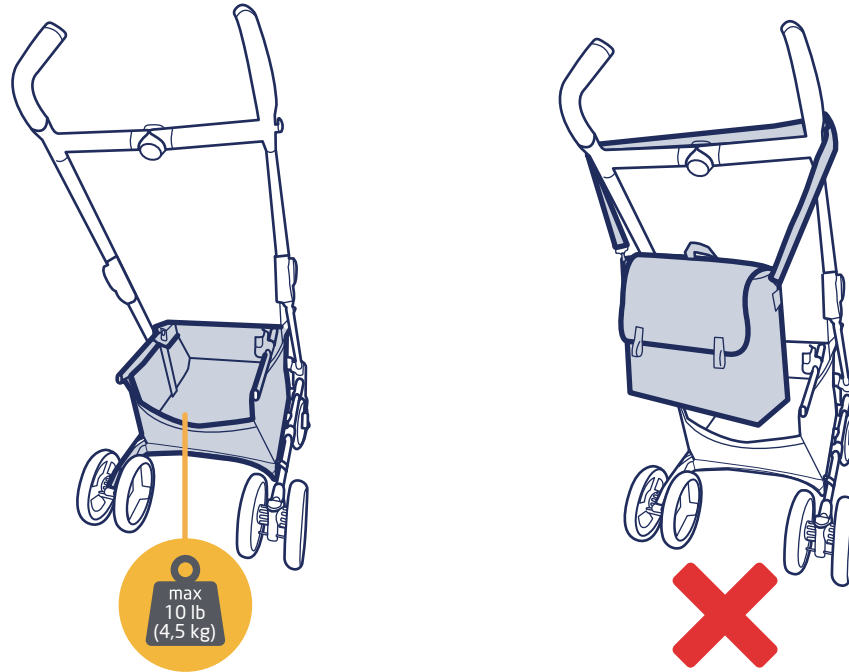

⚠ WARNING:

- **NEVER** place more than 10 lb (4.5 kg) in the storage basket. If the weight is exceeded, hazardous unstable conditions may exist.

Folding Stroller

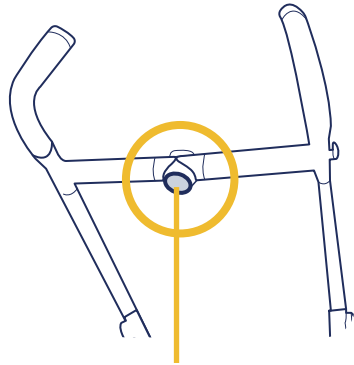

Release Button

1

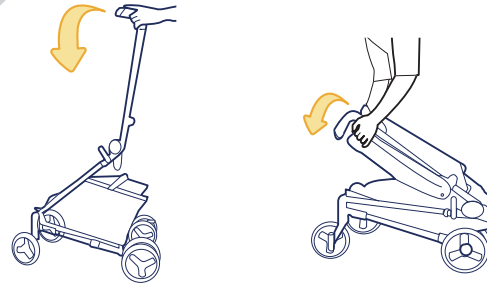

- Press the release button and pull the crossbar away from the stroller.
- With the lock and crossbar disengaged, push the top of the stroller forward until the stroller starts to fold.
- Then lower the stroller frame until it folds together.

2



Push down on the frame so the stroller latch locks into place.

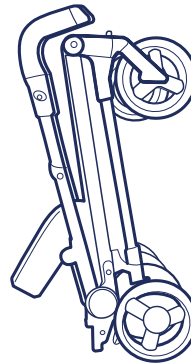

Finished!

The stroller is self-standing.

⚠ WARNING:

ALWAYS keep fingers away from moving parts, when folding, unfolding, or adjusting stroller to prevent finger entrapment.

Accessory Use & Care

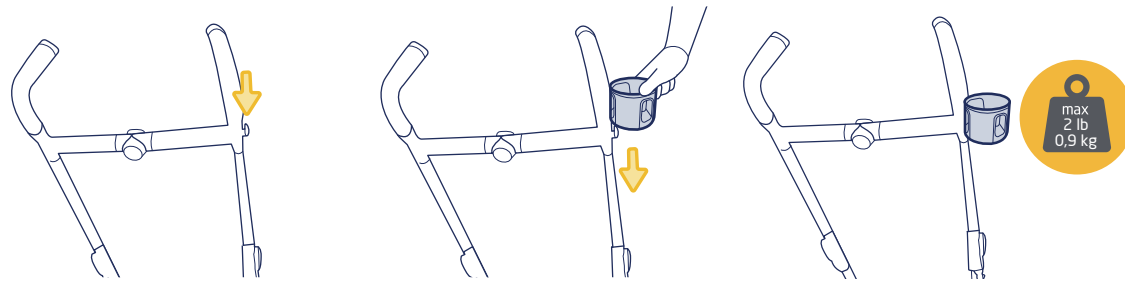

Cup Holder

Secure the cup holder to the attachment on the side of the stroller as shown.
The cup holder is top-rack dishwasher safe.

WARNING:

NEVER place more than 2 lb (.9 kg) in the cup holder.

Wash & Care of Stroller Parts

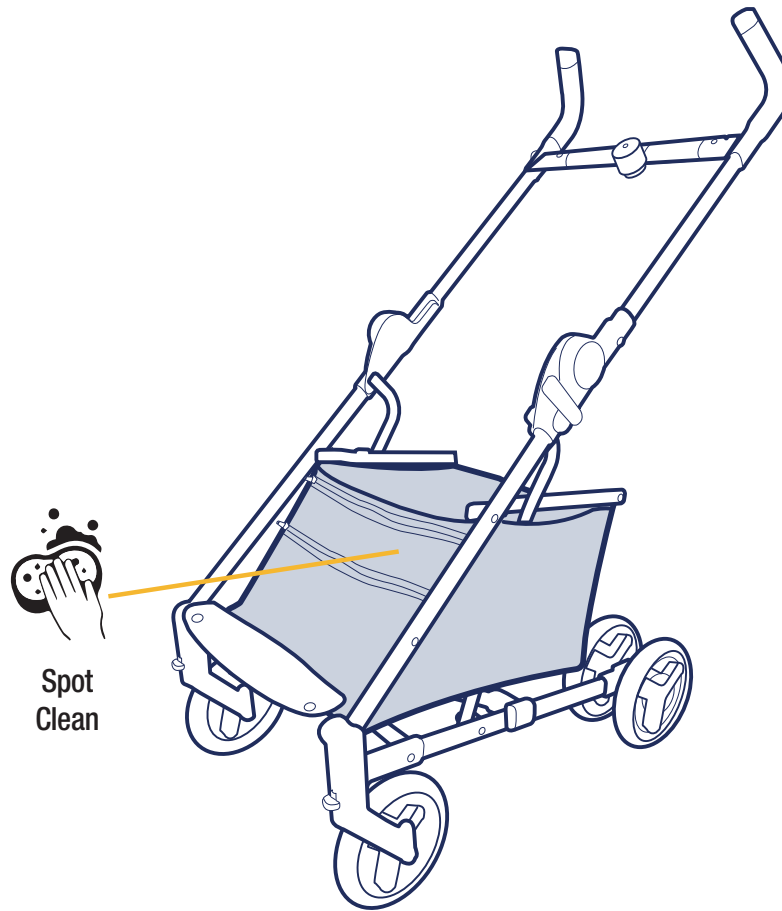

Dorel Juvenile Group Information

Thank you for choosing this stroller.

The DJG family is committed to creating strollers with the most comfort and convenience available today.

If you have questions or any concerns with this stroller, please contact our Consumer Care Department.

For parts availability and questions, please contact us via phone, text, or chat.

Include the model number and manufacture date (found on a sticker on the stroller frame) and a brief description of the part.

- Front Wheels (2)
- Cup Holder
- Car Seat Adapters



Call: 1-800-951-4113



Text: 1-812-652-2525



Chat: www.maxicosi.com

Hours of Operation:

M-TH: 8:00 AM - 6:00 PM EST

FRI: 8:00 AM - 4:30 PM EST

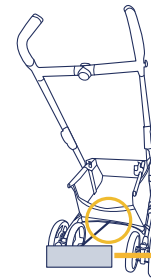

**Date of
Manufacture Label**

Two-Year Limited Warranty

Dorel Juvenile Group, Inc. warrants to the original purchaser that this product (Maxi-Taxi Ultra Compact Car Seat Caddy), is free from material and workmanship defects when used under normal conditions for a period of two (2) years from the date of purchase. Should the product contain defects in material or workmanship Dorel Juvenile Group, Inc., will repair or replace the product, at our option, free of charge. Purchaser will be responsible for all costs associated with packaging and shipping the product to Dorel Juvenile Group Consumer Care Department at the address noted on the back of this document and all other freight or insurance costs associated with the return. Dorel Juvenile Group will bear the cost of shipping the repaired or replaced product to the purchaser. Product should be returned in its original package accompanied by a proof of purchase, either a sales receipt or other proof that the product is within the warranty period. This warranty is void if the owner repairs or modifies the product or the product has been damaged as a result of misuse. This warranty excludes any liability other than that expressly stated previously, including but not limited to, any incidental or consequential damages. SOME STATES DO NOT ALLOW THE EXCLUSION OR LIMITATION OF INCIDENTAL OR CONSEQUENTIAL DAMAGES, SO THE ABOVE LIMITATION OR EXCLUSION MAY NOT APPLY TO YOU. THIS WARRANTY GIVES YOU SPECIFIC LEGAL RIGHTS, AND YOU MAY ALSO HAVE OTHER RIGHTS THAT MAY VARY FROM STATE TO STATE.



Mara-Taxi XT

Ultra Compact Car Seat Caddy



©2021 Dorel Juvenile Group, Inc. (800) 951-4113 www.maxicosi.com. Styles and colors may vary. Les styles et les couleurs peuvent varier. Made in CHINA.
Fabriqué en CHINE. Distributed by (distribué par) Dorel Juvenile Group, Inc., 2525 State St., Columbus, IN 47201-7494. Dorel Juvenile Canada, 2855 Argenta Road, Unit 4, Mississauga, ON L5N 8G6. Importado y Distribuido en Chile por: Comercial e Industrial Silfa S.A. - San Ignacio 0201 / Parque Industrial Portezuelo Quilicura, Santiago Chile. Fono (562) 2339 9000. En Perú por: Comexa S.A. - Los Libertadores 455 - San Isidro, Lima - Perú. Fono (511) 4469014. En Centro América, Caribe y Ecuador por: Best Brands Group S.A. - Av. Balboa, Bay Mall Plaza, Planta Baja, local 9, Panamá. - Fono: (507) 300 2884. En Colombia por: Baby Universe S.A.S. - Vía 40 No. 77-29, Barranquilla, Colombia - Fono: (575) 353 1110 Importador: DJGM, S.A. DE C.V. Gabriel Mancera No. 1041 Col. Del Valle, Benito Juárez C.P. 03100 México, Ciudad de México R.F.C. DJG140305GN9 Tel. (55) 67199202



www.maxicosi.com