

COSCO®

SIMPLE

SMART

FUN

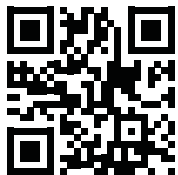

To see installation videos, scan the QR Code or visit coscokids.com.

©2016 Dorel Juvenile. All Rights Reserved.

4358-7081A



2.9.17

COSCO®

 LOWER ANCHOR
Page 17

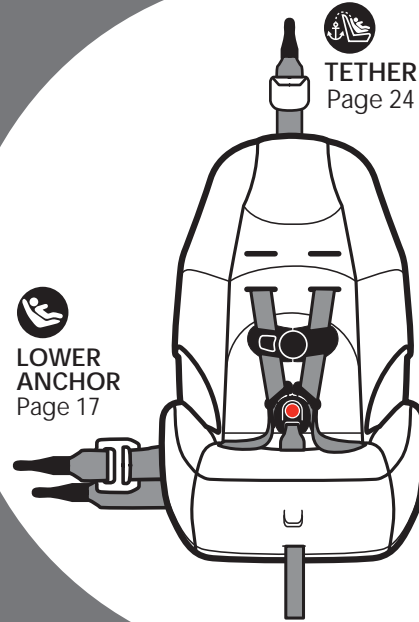

 TETHER
Page 24

HIGHBACK 2-in-1 BOOSTER CAR SEAT

Forward Facing: 22-40 lb and 34-43 in.
And at least 1 year old
(10.1-18 kg and 85.1-110 cm)

Belt-Positioning Booster: 40-80 lb and 43-52 in.
(18.1-36.3 kg and 110.1-132.1 cm)

KEEP INSTRUCTIONS FOR FUTURE USE.
Read all instructions before using this child restraint.

WARNING:

Failure to follow the warnings on the labels and in the instruction manual can result in serious injury or death to your child.

Choosing Forward Facing or Booster Seat

Your child's height, weight, and age determine how your child restraint should be placed in the vehicle.

Please talk to your doctor about the best option for your child.

This child restraint must always be used forward facing with the internal harness system or as a booster seat.

⚠ WARNING: Verify your child's weight and height (do not guess) before choosing the child restraint's placement.

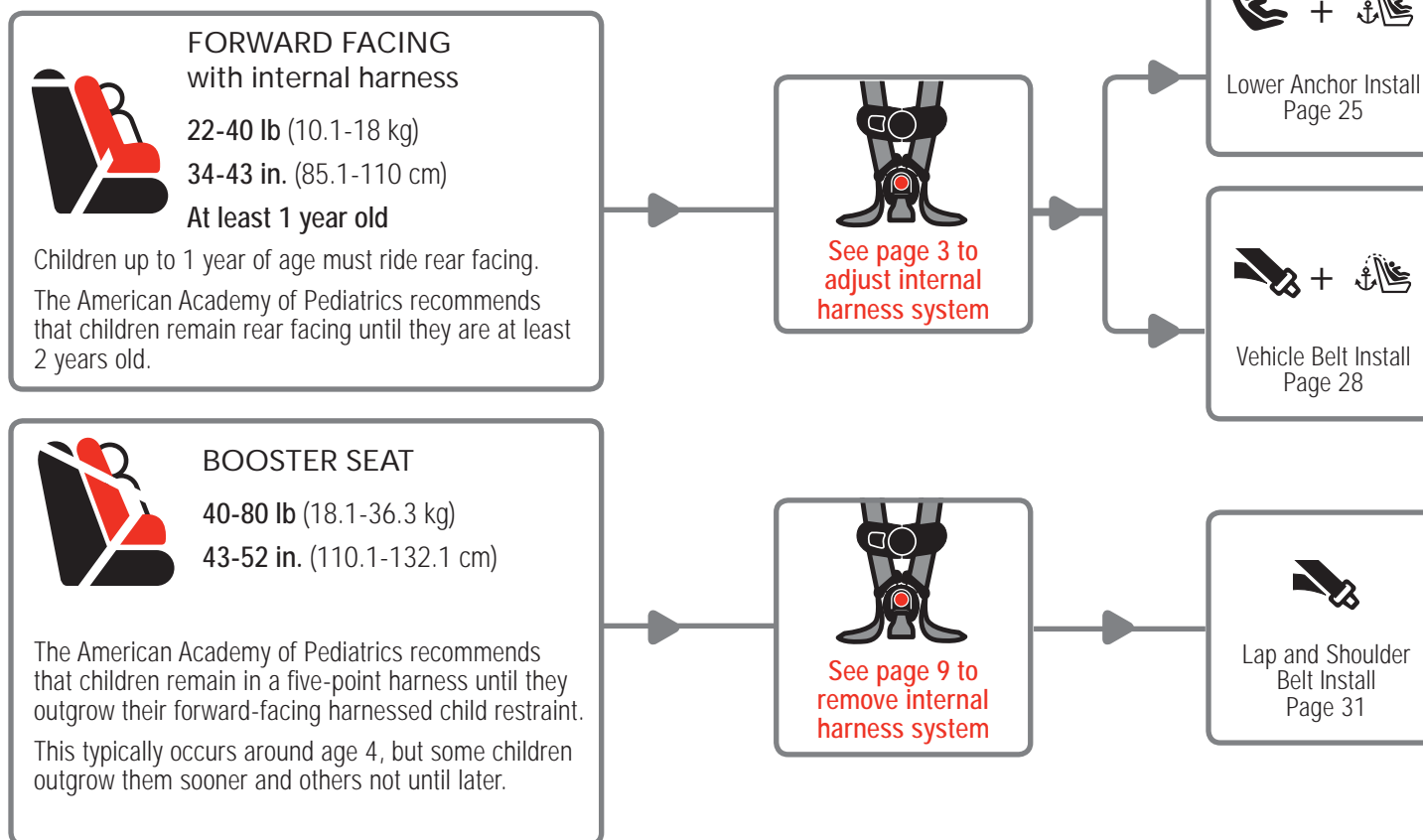



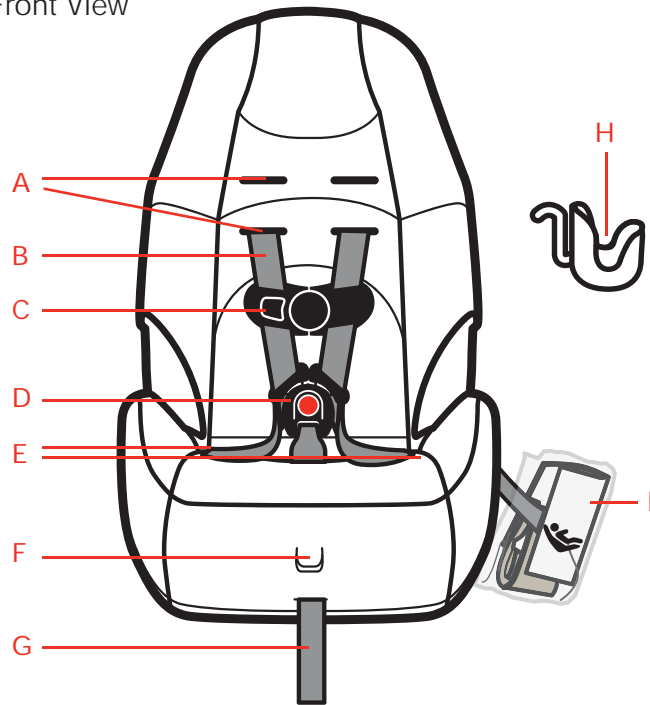

Table of Contents

● Getting Started	1	● Forward Facing	23
Parts of the Child Restraint.....	1	 Tether Use	24
Prepare Child Restraint to Fit Your Child	3	 Lower Anchor Installation	25
How Does Your Child Fit?	4	 Vehicle Belt Installation	28
Changing Position of Shoulder Harness Strap	5	● Booster Seat.....	30
Securing Child in Child Restraint.....	7	 Lap and Shoulder Belt Installation.....	31
● General Use.....	9	● Important Information	32
Removing Harness System	9	Using a Locking Clip	32
Removing Seat Pad for Cleaning.....	11	Dorel Juvenile Group Information.....	35
Installing Harness System	12	Troubleshooting.....	36
Accessories	14	Registration and Safety Notices	37
● Safety Information	15	Warranty.....	39
Child Restraint Use	15	Replacement Parts Order Form.....	40
Installation in Vehicle	15		
Vehicle Seating Position	16		
● Vehicle Information	17		
Choosing Lower Anchor or Vehicle Belts.....	17		
Knowing Your Vehicle Belts.....	19		
Aircraft Information	22		

Parts of the Child Restraint

Front View



- | | |
|----------------------------------|--|
| A. Shoulder Harness Slots | F. Harness Release Lever (under flap) |
| B. Harness Strap | G. Harness Adjustment Strap |
| C. Chest Clip | H. Cup Holder (see page 14) |
| D. Buckle | I. Lower Anchor Belt (see page 17) |
| E. Hip Harness Slots | |

Side View

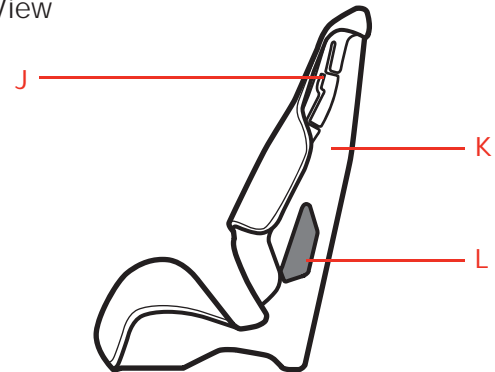

Back View

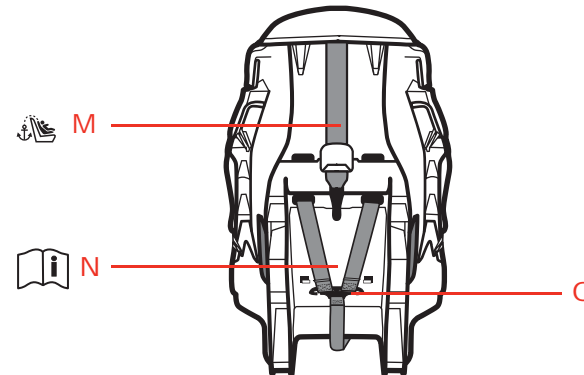

- | | |
|------------------------------------|--------------------------------------|
| J. Belt-Positioning Guide | M. Tether (see page 24) |
| K. Shell (child restraint) | N. Instruction Manual Storage |
| L. Forward-Facing Belt Path | O. Splitter Plate |

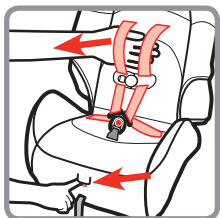

1. Fully Loosen Harness Strap

Push down on harness release lever (under flap on front of seat pad) while pulling out on harness straps as shown.



2. Unbuckle Harness

Press in towards the **top** of the red button.
Pull buckle tongues out.

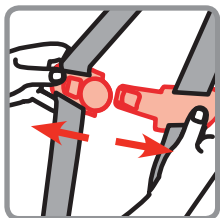

3. Release Chest Clip

Press on chest clip release button and pull apart.
Place harness straps out of the way.

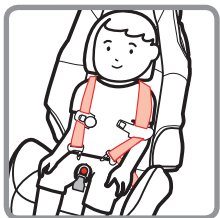

4. Place Child in Child Restraint to Determine Proper Harness Fit

The child's bottom and back should be flat against the child restraint.

See page 4 for fit guidelines.

Use the guidelines below to determine if the harness strap is in the right place for your child.

**FORWARD FACING
with Internal Harness**



Always choose the shoulder harness slot that is closest to your child's shoulder height.

Harness strap **MUST** be at or slightly above shoulders. **To make changes to the harness strap**, see pages 5-6.

If the highest shoulder harness slots are below the child's shoulders, and the child weighs at least 40 lb (18 kg), you must convert the child restraint to a booster seat.

To prepare seat as a booster, see pages 9-10.



Changing Position of Shoulder Harness Strap

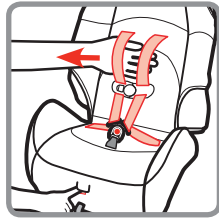

1. Fully Loosen Harness Strap

Push down on harness release lever (under flap on front of seat pad) while pulling out on harness straps as shown.



2. From Back, Remove Harness Strap Loops From Splitter Plate

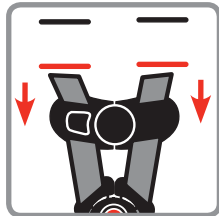

3. Pull Harness Strap Out of Shoulder Harness Slots

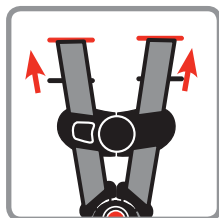

4. Rethread Harness Strap into Correct Shoulder Harness Slots For Your Child

See page 4 for fit guidelines.

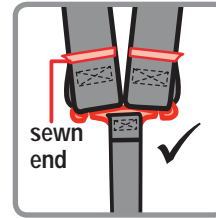

5. Attach Harness Strap Loops to Splitter Plate As Shown

Sewn ends of the harness strap loops **MUST** face towards you.

DO NOT twist harness strap or harness adjustment strap.

Make sure the loops are fitted **COMPLETELY ON** both sides of the splitter plate.

⚠ WARNINGS: Make sure that harness height is correct for your child's size.



Do not use this child restraint forward facing if the tops of your child's ears are above the top of the child restraint.

Failure to follow these steps can result in serious injury or death.



Securing Child in Child Restraint



1. Place Child in Child Restraint

The child's bottom and back should be flat against the child restraint.

Position harness strap over child's shoulders and upper thighs.



2. Buckle Harness

Push buckle tongues into buckle until you hear them "click."

Pull up on harness strap to make sure buckle is locked.

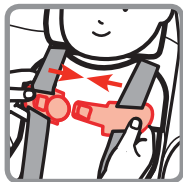

3. Close Chest Clip

Insert right half of chest clip into left half and snap together.

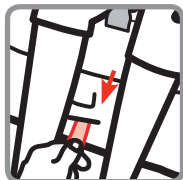

4. Tighten Harness

Pull on harness adjustment strap to tighten harness snugly.



5. Position Chest Clip

The chest clip must be placed at mid-chest (even with armpits) and away from the child's neck.

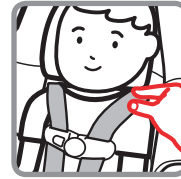

6. Check Harness Tightness

Try to pinch the harness at the shoulders vertically between index finger and thumb as shown.

If your fingers slip off, the harness is tight enough.

If you can pinch the harness strap, tighten more. The harness strap should be snug throughout their length.

A snug strap should not allow any slack. It lies in a relatively straight line without sagging. It does not press on the child's flesh or push the child's body into an unnatural position.

⚠ WARNINGS: Failure to fasten and tighten the harness system correctly may allow the child to be ejected from the child restraint in a crash or sudden stop causing serious injury or death.



Do not mistake comfort for safety. Harness system must be snugly adjusted.

DO NOT put snowsuits or bulky garments on your child when placing them in the child restraint.

Bulky clothing can prevent the harness straps from being tightened properly.

To Remove Child From Child Restraint

1. Loosen Harness Strap
2. Unbuckle Harness
3. Release Chest Clip
4. Remove Child



Removing Harness System

Only remove the harness system to clean seat pad or when changing child restraint to a booster seat.

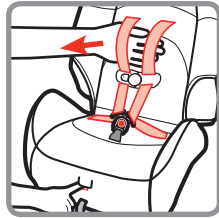

1. Fully Loosen Harness Straps

Push down on harness release lever (under flap on front of seat pad) while pulling out on harness straps as shown.



2. From Back, Remove Harness Strap Loops From Splitter Plate

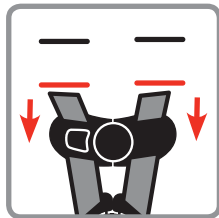

3. Pull Harness Strap Out of Shoulder Harness Slots

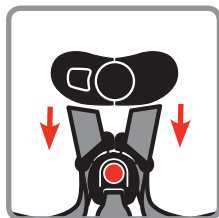

4. Unthread Chest Clip

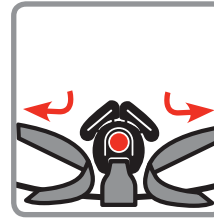

5. Unthread Buckle

Do not unbuckle the buckle.

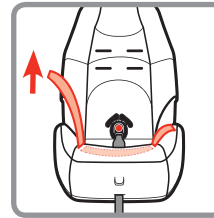

6. Pull Harness Strap Out of Seat

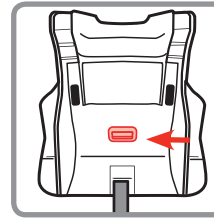

7. Turn Seat Over

Locate buckle's metal retainer on bottom of shell.

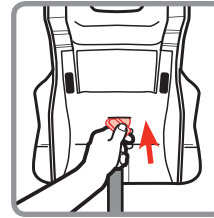

8. Rotate Metal Retainer and Push It Up Through Shell and Pad

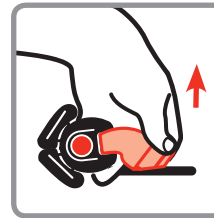

9. From Top of Seat, Pull Buckle Out of Shell

Store the buckle and harness strap in a safe place for future use.



Removing Seat Pad for Cleaning

You must remove the harness system to remove the pad from the shell. See pages 9-10.

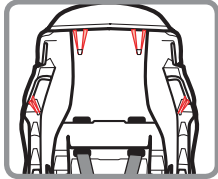

1. Release Elastic Straps on Back and Bottom of the Shell

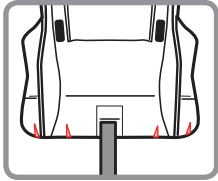

2. Remove Pad
Pull pad off the bottom of child restraint and remove pad.

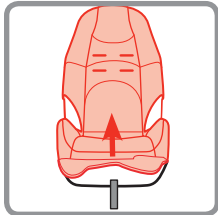

⚠ WARNINGS: Do not use child restraint without the seat pad. Failure to do this can result in serious injury or death.

Cleaning Pad

Machine wash separately with cold water on a gentle cycle. Do not use bleach. Tumble dry separately for 10-12 minutes on low heat. Remove immediately.

Cleaning Harness Straps

Spot clean using warm sudsy water and damp cloth.

Replace Pad

Starting from bottom of child restraint, slip pad on shell. Pull harness adjustment strap through pad. Wrap pad around the top of shell. Attach all of the elastic straps. Install harness system, see pages 12-13.



Installing Harness System



1. Insert Buckle's Metal Retainer into Slot
Buckle **MUST** face out.

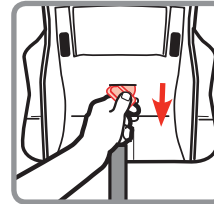

2. Pull Metal Retainer Completely Through Pad and Shell

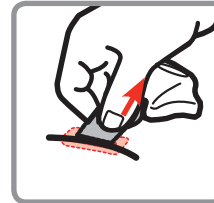

3. Check Buckle
Pull up on buckle to make sure it is secured.
The buckle **MUST** not pull out.

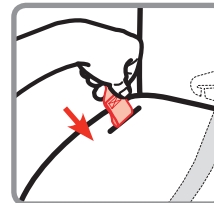

4. Rethread Harness Strap
With sewn end of harness strap loop facing the buckle, thread harness strap down through hip harness slot.

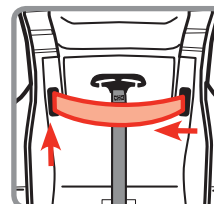

5. Pull Harness Strap Across Bottom of Shell
Harness strap **MUST** lay in front harness adjustment strap as shown. Push harness strap up through other hip harness slot.

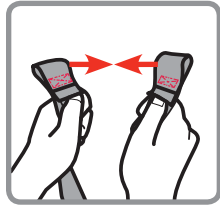

6. Make Harness Strap Even

Sewn ends of harness strap loops **MUST** face each other.

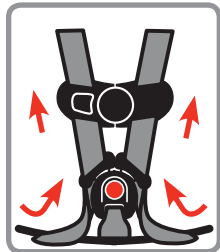

7. Thread Buckle and Chest Clip

Harness strap ends go through the back of buckle tongues and through the chest clip front to back as shown.

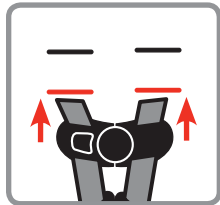

8. Thread Harness Strap Into Correct Shoulder Harness Slots For Your Child

See page 4 for fit guidelines.

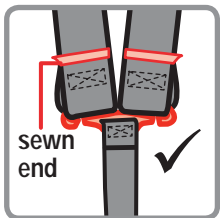

9. Attach Harness Strap Loops to Splitter Plate As Shown

Sewn ends of the harness strap loops **MUST** face towards you.

DO NOT twist harness strap or harness adjustment strap.

Make sure the loops are fitted **COMPLETELY ON** both sides of the splitter plate.

⚠ WARNINGS: Harness system must be installed correctly. Failure to follow these steps can result in serious injury or death.

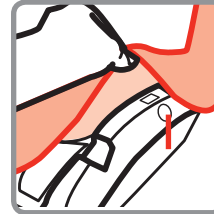

Cup Holder

The cup holder can be attached to either side of the shell.

Pull pad off corner of shell.

Align symbol on cup holder with symbol on shell.

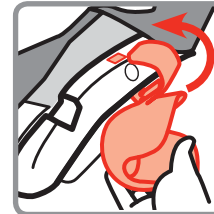

Hook bottom of cup holder under edge of shell.

Snap top of cup holder over edge of shell.

Replace pad.

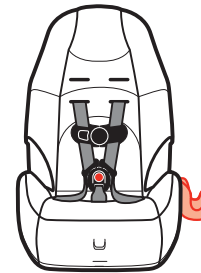



Child Restraint Use

Never take your child out of the child restraint while the vehicle is moving.

Never leave child unattended.

Placing your child in a hot child restraint may result in burns.

Do not use a child restraint with damaged or missing parts.

Do not use cut, frayed or damaged harnesses.

Do not substitute parts or try to modify the child restraint in any way.

Do not lubricate buckles and fasteners.

Do not use any child restraint accessory except those approved by Dorel Juvenile Group.

Never allow any child to play with this child restraint; it is not a toy.

Do not remove or cover up any of the warning labels or other labels on the child restraint.

Read all instructions for additional warnings.

On the side of the child restraint there is a date of manufacture label. Do not use this child restraint more than 10 years after the date of manufacture.

Installation in Vehicle

Check the vehicle belt or Lower Anchor belt before each use. Use only if the belt is tightened properly and locked securely in place.

This child restraint should be securely belted in the vehicle even when not in use. In a crash or sudden stop, an unsecured child restraint could injure occupants.

Do not use a child restraint that has been in a crash. You must get a new child restraint.

Vehicle Seating Position



Check the vehicle owner's manual for more information about air bag/child restraint use.

Use the child restraint only on vehicle seats that face forward.



Do not use on seats that face the sides or rear of the vehicle.

Use the center seating position if possible.



For vehicles without a back seat, refer to your vehicle owner's manual.

If you are not sure where to place the child restraint in your vehicle, consult your vehicle owner's manual, contact Dorel Juvenile Group Consumer Care Department, or visit your local Child Passenger Inspection Station. Go to <http://www.safercar.gov/cpsApp/cps/index.htm> to find your closest station.



Children are safer when properly restrained in rear seating positions than in the front seating positions.

According to National Highway Traffic Safety Administration information, children in rear seating

positions are statistically safer, whether you have air bags, advanced air bags, or no air bags at all.

To avoid your child being seriously burned, take the following precautions:

1. Park in the shade or where sun does not directly hit the child restraint.
2. Cover the child restraint with a sheet or blanket when not in use.
3. Check for hot seat and buckles before placing child in child restraint.

To help protect your vehicle seat's upholstery from damage, use a single layer towel underneath and behind child restraint.



Choosing Lower Anchor or Vehicle Belts

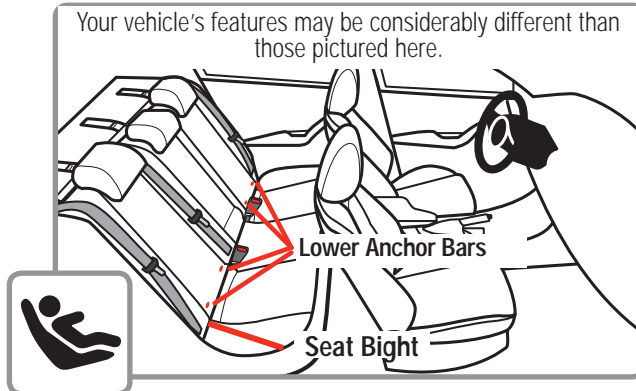

The LATCH System

The lower anchors of LATCH (Lower Anchors and Tethers for Children) is a universal system for installing child restraints without using vehicle seat belts.

The lower anchor system can **ONLY** be used in vehicles that have the lower anchor bars installed and designated LATCH seating positions. Most vehicles manufactured after September 2002 are equipped with lower anchor bars.

Check your vehicle owner's manual to see which seating positions may be equipped with the LATCH system.

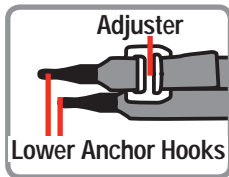

When installing this child restraint with vehicle belts or when using as a booster seat, the lower anchor hooks and belt MUST be properly stored.

Storing Lower Anchor Belt

Thread lower anchor belt through forward facing belt path and fasten lower anchor hooks together behind the child restraint as shown. Gently pull free end of belt to remove slack.

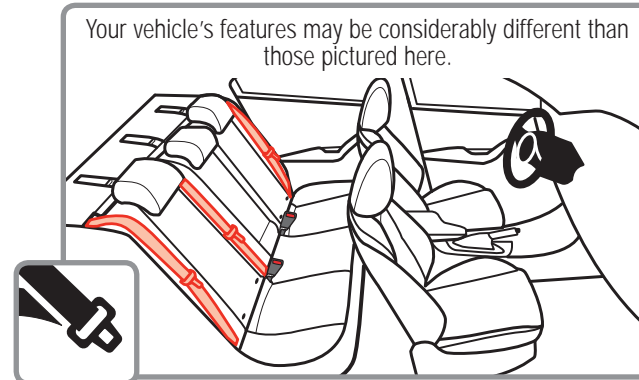

Vehicle Belts

If lower anchors are not an option, you must use the vehicle seat belt system to install the child restraint.

There are some vehicle belts that will not work with a child restraint or will require special attention.

Check your vehicle owner's manual for specific instructions.

⚠️ WARNINGS: When used correctly the lower anchor belt or vehicle belts are equally safe. Do not use both the lower anchor belt and vehicle belt at the same time.



Knowing Your Vehicle Belts

Not all vehicle belts and seating positions will work with child restraints. Please follow the following steps to understand how to lock a child restraint with a vehicle belt.



1. You MUST Review Your Vehicle Owner's Manual

Your vehicle owner's manual will let you know what vehicle belts and seating positions child restraints can be installed in.



2. Determine How the Child Restraint Will Be Locked Into Place

The vehicle belt **MUST NOT** loosen after tightening.

This means there needs to be a way to lock the vehicle belt.

The ways this can be done are:

- By using the seat belt's retractor; or
- By using the seat belt's latch plate.

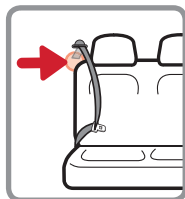

3. Check the Retractor

Retractors pull seat belts into stored positions and lock the belt to hold passengers in place.

A retractor is most likely how you will be locking a child restraint into place.

See the next page for some common types of vehicle belt retractors that will work with this child restraint.

Types of Retractors

Switchable Retractor (most vehicles have this type)



This retractor can be switched to a locking mode.

You **MUST** have the retractor in the locking mode to use the seat belt with this child restraint.

Switching to locking mode: Slowly pull the shoulder belt all the way out, then let it go back in an inch or two.

As it goes back in, you will most likely hear a ratcheting sound.

Gently pull the belt to see if it has locked. You will not be able to pull any more belt out if the lock has engaged.

Automatic Locking Retractor



This retractor always locks.

It will automatically lock after slowly pulling the seat belt out at least halfway and letting the belt go back into the retractor an inch or two.

Emergency Locking Retractor

See Step 4, "Check the Latch Plates," on next page.

If the retractor does not lock, it is most likely an Emergency Locking Retractor. These retractors only lock during a sudden stop or collision.

You will need to determine if your seat belt's latch plate can lock the belt. See Step 4, "Check the Latch Plates," on next page.



4. Check the Latch Plates

Latch plates are the part of the seat belt that goes into the buckle.

Hold the lap belt with one hand and with your other hand grasp the tongue of the latch plate (the part that goes inside the buckle) pull straight out, in line with the lap belt.

If the latch plate does not slide up and down the vehicle belt, it is a **locking latch plate**.

If the latch plate slides up and down the vehicle belt, it is a **sliding latch plate**.

Sliding latch plates easily slip between the lap and shoulder portions of the belt.

If you have an Emergency Locking Retractor with a Sliding Latch Plate, you **MUST** use a locking clip to install the child restraint. See pages 32-34.

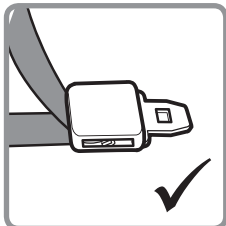

Locking Latch Plate

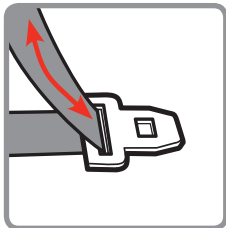

Emergency Locking Retractor with a Sliding Latch Plate

Never Use With This Child Restraint	
Emergency Locking Retractor Lap Only Belt	✘
Inflatable Seat Belts	✘

This restraint is certified for aircraft use when used with the internal harness.

This child restraint is not certified for aircraft use when used as a booster seat because aircraft seats do not have shoulder belts.

Install the child restraint in a window seat to avoid blocking the aisle. If the aircraft lap belt is too short, ask the flight attendant for a belt extender.

Use only on forward facing aircraft seats.

Contact the airline for their specific policies.

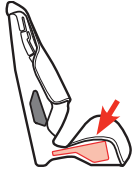

Some airlines may ask to see a label stating that this child restraint is certified for aircraft use.

There is an airplane certification label located on the side of this child restraint as shown.

⚠ WARNING: Store lower anchor belts and tether strap when using the aircraft belts.



Forward Facing Aircraft Installation

For forward facing installation follow pages 27-28.



Forward Facing

Tether Use

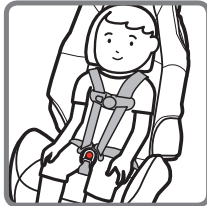

22-40 lb (10.1-18 kg)
34-43 in. (85.1-110 cm)
At least 1 year old



Lower Anchor Belt with Tether



Lap/Shoulder Belt with Tether



Lap Belt with Tether



⚠️ WARNINGS: In this child restraint your child **MUST** be at least 1 year old before they sit forward facing.

The American Academy of Pediatrics recommends that children remain rear facing until they are at least 2 years old and remain in a five-point harness until they outgrow their forward-facing harnessed child restraint.

Please talk to your doctor about the best option for your child.

You **MUST** always attach, adjust, and secure the top anchorage (tether) strap when installing the child restraint forward facing with internal harness. Tethers improve the installation and stability of child restraints and reduce the risk of injury.

Attach the tether hook to the tether anchor designated by your vehicle manufacturer for that seating position. Check your vehicle owner's manual for more information.

If the seating position does not have a tether anchor, use a different seating position or see your dealer or a qualified mechanic and have one installed.

⚠️ WARNING: Do not fasten multiple tether hooks on the same tether anchor in the vehicle.

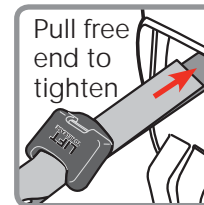

Pull free end to tighten

Adjusting Tether Strap

To tighten: After the child restraint is locked into place with lower anchor belt or vehicle belt, push down on child restraint and gently pull on free end of tether.

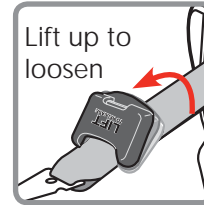

Lift up to loosen

To loosen: Lift up on tether lock adjuster and push it towards tether hook.



Storing Tether Strap

When using as a booster or when not in use, tuck the tether hook and strap under the booster seat.



Lower Anchor Installation

⚠ WARNINGS: Check the lower anchor belt before each use. Use only if the belt can be tightened properly and securely.

Do not fasten multiple lower anchor hooks on the same lower anchor bar in the vehicle.

Failure to follow these warnings can result in serious injury or death.

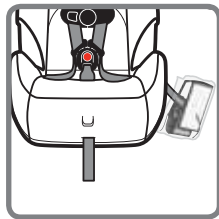

1. Remove Lower Anchor from Packaging

Pull lower anchor belt packaging out of forward-facing belt path.

Remove lower anchor from packaging.

Discard the packaging.

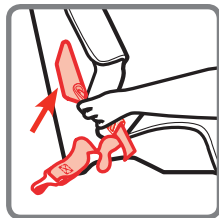

2. Route Lower Anchor Belt Through Forward-Facing Belt Path

Do not twist belt.

Lower anchor adjuster can be on either side.

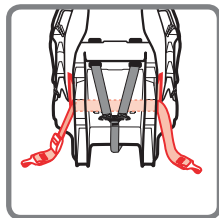

3. Finished Lower Anchor Routing



4. Place Child Restraint Forward Facing Flush Against Vehicle Seat Back

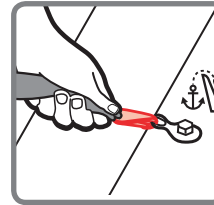

5. Loosely Attach Tether Hook

Check vehicle owner's manual for specific location.

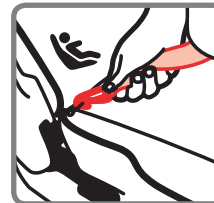

6. Attach Lower Anchor Hooks to Vehicle's Lower Anchors

Review your vehicle owner's manual for lower anchor locations and lower anchor belt use.

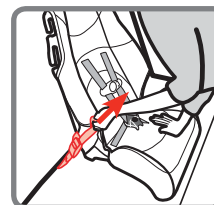

7. Tighten Belt

Place hand in child restraint.

Firmly push down while pulling free end of belt to tighten.



8. Tighten Tether

Push firmly on the back of the seat and pull the tether strap to remove all slack and create tension on the strap.

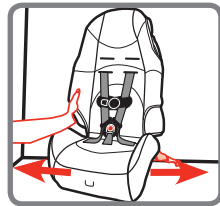

9. Check Belt Tightness

Hold child restraint at the belt path with your weakest hand.

Push and pull from side to side.

It should not move more than 1 in. (2.5 cm).

If it moves more than 1 in. (2.5 cm), you can try:

- A. Putting your knee in the seat and pulling the belt tighter.
- B. Reinstalling the child restraint.
- C. Changing to a different seating location.
- D. Switching to vehicle belt installation.

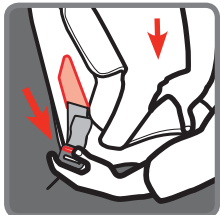

To Release Lower Anchor Belt

Remove child from child restraint.

Remove tension from the lower anchor belt by pushing down on side of child restraint with the lower anchor belt adjuster. Then press the adjuster button to loosen belt.

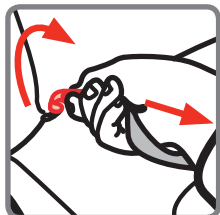

Unhook from anchor by squeezing spring lever on hook, pushing hook back into the seat bight, and twisting. Then pull it out of the vehicle seat.

Store lower anchor belt when not in use. See page 17.

⚠ WARNINGS: Do not use the lower anchor belt along with the vehicle lap or lap/shoulder belt. Store lower anchor hooks and belt as shown when installing with vehicle belts. Check vehicle belt before each use. Use only if the belt can be tightened properly and locked securely in place.

Failure to follow these warnings can result in serious injury or death.



1. Place Child Restraint Forward Facing Flush Against Vehicle Seat Back

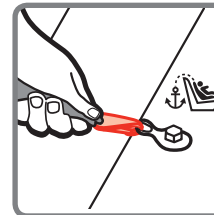

2. Loosely Attach Tether Hook

Check vehicle owner's manual for specific location.



3. Check if Your Vehicle Belts Will Work With This Child Restraint

This is very important because **not all vehicle belts will work with child restraints.**

Review pages 19-21 and your vehicle owner's manual to determine what kind of vehicle belt you have and how to lock a child restraint in place.

Booster Seat

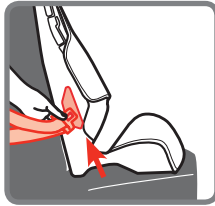

4. Route Vehicle Lap or Lap/Shoulder Belt Through Forward-Facing Belt Path

Do not twist belt.
Buckle vehicle belt.

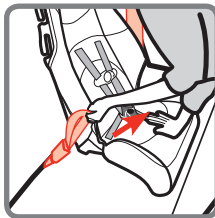

5. Tighten Belt

Place hand in child restraint.
Firmly push down while pulling shoulder belt or free end of lap belt to tighten.

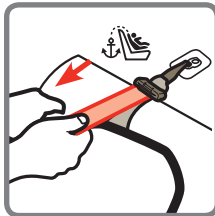

6. Tighten Tether

Push firmly on the back of the seat and pull the tether strap to remove all slack and create tension on the strap.



7. Check Belt Tightness

Hold child restraint at the belt path with your weakest hand.
Push and pull from side to side.
It should not move more than 1 in. (2.5 cm).

If it moves more than 1 in. (2.5 cm), you can try:
A. Putting your knee in the seat and pulling the belt tighter.
B. Reinstalling the child restraint. C. Changing to a different seating location. D. Switching to the lower anchor belt installation if lower anchors are available in your vehicle.



40-80 lb (18.1-36.3 kg)
43-52 in. (110.1-132.1 cm)

 Lap/Shoulder Belt

You **MUST** remove the harness system to use as a booster seat. See pages 9-10.

⚠ WARNINGS: Do not use the harness system when using as a booster seat.

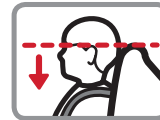

Do not use this booster seat if the tops of your child's ears are above the top of the booster seat.



Use only the vehicle's lap and shoulder belt system when restraining the child in this booster seat.

Do not use only the lap belt when using this seat as a booster seat.



The shoulder belt must always be adjusted snugly across the child's chest. **NEVER** place the shoulder belt under the child's arms.

Do not use the LATCH system when using as a booster seat. Secure lower anchor belt and tether strap to their storage locations.



Failure to follow these warnings can result in serious injury or death.

The American Academy of Pediatrics recommends that children remain in a five-point harness until they outgrow their forward-facing harnessed child restraint.

This typically occurs around age 4, but some children outgrow them sooner and others not until later.

Please talk to your doctor about the best option for your child.



1. Place Booster Seat Forward Facing Flush Against Vehicle Seat Back

Tuck the tether hook and strap under the booster seat.



2. Position Lap Belt on Child

The lap belt should lay snugly across the child's upper thighs and not on the stomach.

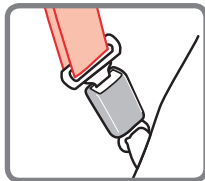

3. Buckle Vehicle Belt



4. Position Shoulder Belt on Child

Pull up on shoulder belt to tighten.

The shoulder belt should lay snugly across the center of the child's shoulders and across the chest and not on the face or neck.



To help position the shoulder belt, you may need to secure the shoulder belt in one of the notches in the shoulder belt-positioning guides.

NOTE: Use the shoulder belt positioning guide only if necessary to correctly position the shoulder belt on the child. Check periodically to ensure your child has not moved out of position and loosened the shoulder belt.

You will rarely need to use a locking clip except in some older vehicles.

Built-in child restraint locking systems have been required in vehicles since 1996, and many vehicles had these features even earlier. Review pages 19-21 and your vehicle owner's manual to determine if your vehicle belts require a locking clip.

If you need a locking clip immediately, they are likely available at an auto dealership, an auto store, or where you purchased this child restraint. You can call us at 1-800-544-1108 for one.

A locking clip will not fix all types of seat belt problems. You **MUST** have a lap and shoulder belt to use a locking clip.

Do not use the locking clip when using this seat as a booster seat.

For Forward Facing installation, follow Pages 28-29 Warnings and Steps 1-5 before starting locking clip installation.

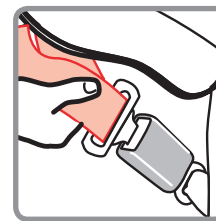

1. Determine Locking Clip Position

Grasp both vehicle belts together just behind the latch plate to mark the position for locking clip.

Unbuckle the belt.

NOTE: If the latch plate ends up just at the belt path opening so you cannot grasp the vehicle belt at the latch plate, grasp the vehicle belts on the opposite side of the child restraint, as close to the latch plate as possible.

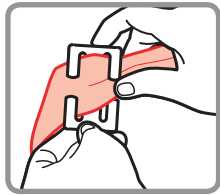

2. Attach Locking Clip

Thread both portions of the vehicle belt onto the locking clip, as close to the latch plate as possible.

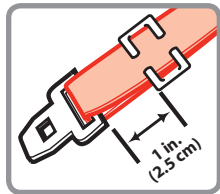

3. Position Locking Clip

It should be about 1 in. (2.5 cm) from vehicle belt's latch plate.

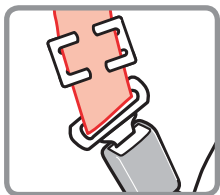

4. Rebuckle Vehicle Belt

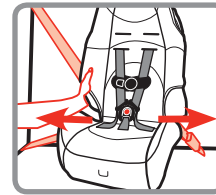

5. Check Belt Tightness

Hold child restraint at the belt path with your weakest hand.

Push and pull from side to side.

If it moves more than 1 in. (2.5 cm), try reinstalling the child restraint or try another seating location.

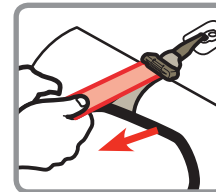

6. Tighten Tether

With knee in child restraint, push firmly on the back of the seat and tighten tether strap.

Remove the locking clip when the seat belt is not being used with a child restraint.

Thank you for choosing this child restraint. The DJG family is committed to creating child restraints with the most comfort and convenience available today.

Remember, parents are a child's first teachers and examples. If you always buckle your seat belt, your child will think it is the natural thing to do. Make it a firm rule that the vehicle does not go until everyone is buckled up. Make no exceptions.

No one can predict if use of a child restraint will prevent injury or death in a particular crash. However, when combined with careful driving, proper use of a child restraint can lower a child's risk of injury or death in most crashes.

Your child's safety is worth the time it will take to read and follow these instructions. After reading, if you still have questions or have any concerns with this child restraint, please contact our Consumer Care Department at:

Website: www.coscokids.com

Telephone: 1-800-544-1108

M-TH from 8 A.M. to 6 P.M. EST

FRI from 8 A.M. to 4:30 P.M. EST

Mailing Address:

Dorel Juvenile Group, Inc.
Consumer Care Department
P.O. Box 2609
Columbus, IN 47202-2609

1. Locate a Child Safety Seat Inspection Station for hands on training on how to use your child restraint:

Visit your local Child Passenger Inspection Station or go to <http://www.safercar.gov/cpsApp/cps/index.htm> to find your closest station.

2. If the child restraint buckle or harness release lever sticks or you cannot get the straps tight enough around child: DO NOT LUBRICATE.

Check around lever and retractor for dropped food, sticky spilled drinks, dirt, leaves, etc. Clean with warm water and/or remove object with tweezers. If you cannot get the harness to adjust and remain tight with the buckle securely locked, do not use the child restraint.

3. If your harness twists: Straighten the harness each time you put your child in the child restraint to help prevent twisting. Lock the buckle and tighten harness so it will be ready for next use.

Registration and Safety Notices

Please complete the postage-paid registration card that came with your child restraint, and send it to us.

Child restraints could be recalled for safety reasons.

You must register this restraint to be reached in a recall.

Send your name, address, email address if available and the restraint's model number and manufacturing date to:

Dorel Juvenile Group, Inc.
Consumer Care Department
PO Box 2609
Columbus, IN 47202-2609

or call 1-800-544-1108 or register online at www.djgusa.com/registration/carseat/us.

For recall information, call the U.S. Government's Vehicle Safety Hotline at 1-888-327-4236 (TTY: 1-800-424-9153), or go to <http://www.NHTSA.gov>.

Consumer: Just fill in your name, address and email. Please print (use dark ink).

Your Name _____

Your Street Address _____

City _____ State _____

Model Number (optional) _____ **Line Code** _____ **Manufacture Date** _____

Model Number	Model Name	Manufacture Date
AB123CDE	COSCO HIGHBACK 2-in-1	01/22/2015

_____ L#11 B265035

Example of model number, manufacture date, and line code.

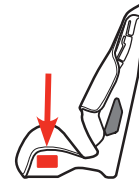

If you don't have the card or if your address changes, you will find the model number, manufacture date, and line code on the label located on side of shell.

Warranty

Dorel Juvenile Group, Inc. (DJG) warrants this product to the original retail purchaser as follows:

This product is warranted against defective materials or workmanship for **one year** from the date of original purchase. **An original receipt is required to validate your warranty.** DJG will, at its option, provide replacement parts or replace this product. DJG reserves the right to substitute if the part or model has been discontinued.

To make a claim under this warranty you write to DJG, Consumer Care Department, P. O. Box 2609, Columbus, IN 47202-2609; or call 1-800-544-1108 from 8:00 a.m. to 6:00 p.m. EST Monday through Thursday and from 8:00 a.m. to 4:30 p.m. on Friday.

Proof of purchase is required and shipping charges are the responsibility of the consumer.

Warranty Limitations: This warranty does not include damages which arise from misuse or abuse of this product.

Limitation of Damages: The warranty and remedies as set forth are exclusive and in lieu of all others, oral or written, expressed or implied. In no event will DJG or the dealer selling this product be liable to you for any damages, including incidental or consequential damages, arising out of the use or inability to use this product.

Limitation of warranties and other warranty terms and state law rights:

Any implied warranties, including implied warranties of the merchantability and fitness for a particular purpose, shall be limited to the duration and terms of the express written warranty. Some states do not allow limitations as to how long an implied warranty lasts or the exclusion or limitation of incidental or consequential damages, so the above limitations may not apply to you.

This warranty gives you specific legal rights, and you may have other rights, which vary from state to state. Neither DJG nor the dealer selling this product authorized any person to create for it any other warranty, obligation, or liability in connection with this product.

Replacement Parts Order Form

Complete the form. Your model number with color code and manufacturer date code **MUST** be included on the form to ensure proper replacement parts. The codes can be found on a label on side of child restraint. Payment in U.S. dollars must accompany your order. Choose parts needed from the list on the next page. Return the form with payment to:

Dorel Juvenile Group, Inc.
Consumer Care Department
P.O. Box 2609
Columbus, IN 47202-2609

Fax orders to: 1-800-207-8182

Please make money orders payable to Dorel Juvenile Group, Inc. Fill in the area on the next page to charge credit card. (Visa or MasterCard **only**). We do not accept cash, personal checks, or other credit cards. All outside of U.S. and Canada **MUST** use credit card.

Ship To: (Please Print)

Name: _____

Address: _____

City: _____

State/Province: _____ **Zip** _____

Telephone: _____

Email Address: _____

We **MUST** have this information:

Model Number (8 to 9 characters): _____

Manufacture Date (mm/dd/yyyy): _____

Replacement Parts List

NOTE: If requested color is not available, similar color will be substituted. Prices are subject to change.

Part	Cost	Qty	Total Cost
Buckle Assembly.....	\$7.99	\$.....
Harness Strap.....	\$2.99	\$.....
Seat Pad.....	\$18.00	\$.....
Chest Clip.....	\$1.50	\$.....
Tether.....	\$6.00	\$.....
Lower Anchor.....	\$17.99	\$.....
Instructions.....	\$0.00	\$.....
Locking Clip.....	\$2.50	\$.....

Merchandise Total: \$.....

Shipping and handling:..... \$.....

Up to \$25.00.....	\$5.95	\$100.01 to \$150.00.....	\$10.95
\$25.01 to \$50.00.....	\$6.95	\$150.01 to \$200.00.....	\$11.95
\$50.01 to \$75.00.....	\$8.95	\$200.01 and up.....	\$13.95
\$75.01 to \$100.00.....	\$9.95	Outside Continental USA.....	\$10.00

Sales Tax \$.....

(Arizona, California, Georgia, Indiana, Missouri, South Carolina, and Texas residents add applicable sales tax.)

Grand Total..... \$.....

No shipping and handling on instructions for quantities under 6. Add \$.50 for each instruction over 6, then add applicable shipping and handling.

Fill Out For Credit Card
 Visa **MasterCard**

Card Exp. Date:

Cardholder's Name:

Card Number:

Signature:

CUT ON DOTTED LINE