

**NANLITE**

*Forza 300B*  
USER MANUAL

Guangdong NanGuang Photo&Video Systems Co., Ltd

# Contents

---

<b>Product Diagram</b> .....	01
<b>Technical Data</b> .....	01
<b>Product Details</b> .....	02
<b>Detailed Description</b> .....	03
<b>Instruction</b>	
1. Connection between the light fixture and battery .....	04
2. Connection between the light fixture and power adapter .....	05
3. Installation of the Reflector .....	06
4. Installation of the Light Stand Clamp .....	07
5. Installation of an Umbrella .....	07
<b>Remote Control</b>	
1. ADDRESS/DMX .....	08
2. DMX Remote Control .....	11
3. 2.4G Remote Control .....	12
4. RDM Remote Control .....	13

## Operating Instructions

1. Screen Interface Display Instructions .....	13
2. CCT Key .....	13
3. EFFECT Key .....	15
4. MENU Key .....	30
①OUTPUT MODE .....	31
②ROTATE SCREEN .....	32
③ADDRESS/DMX .....	32
④WIRELESS PROTOCOL .....	33
⑤FAN .....	34
⑥SCREEN BRIGHTNESS.....	35
⑦BUTTON BACKLIGHT .....	36
⑧LANGUAGE .....	37
⑨VERSION .....	38
5. LOCK Key .....	38
<b>Safety Precautions .....</b>	<b>39</b>
<b>Notice .....</b>	<b>39</b>
<b>Product Includes .....</b>	<b>40</b>
<b>General Fault Detection and Diagnosis .....</b>	<b>41</b>

# Forza 300B LED Bi-color Spot Light

## ■ Product Diagram

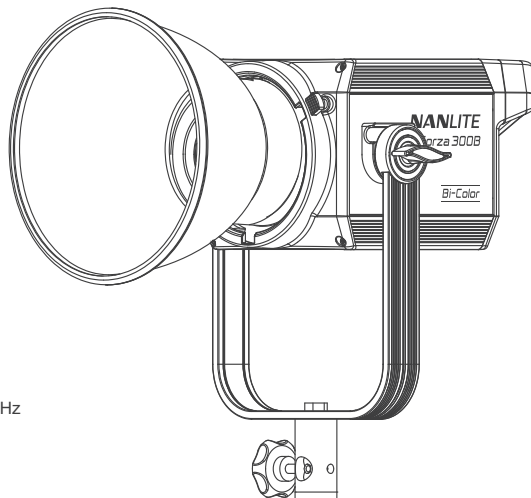

## ■ Technical Data

Rated Power: 355W

Input voltage/current: DC48V/8.4A Max

AC100-240V 50/60Hz

Color Temperature: 2700K-6500K

CRI: Average 96

TLCI: Average 98



## Product Details

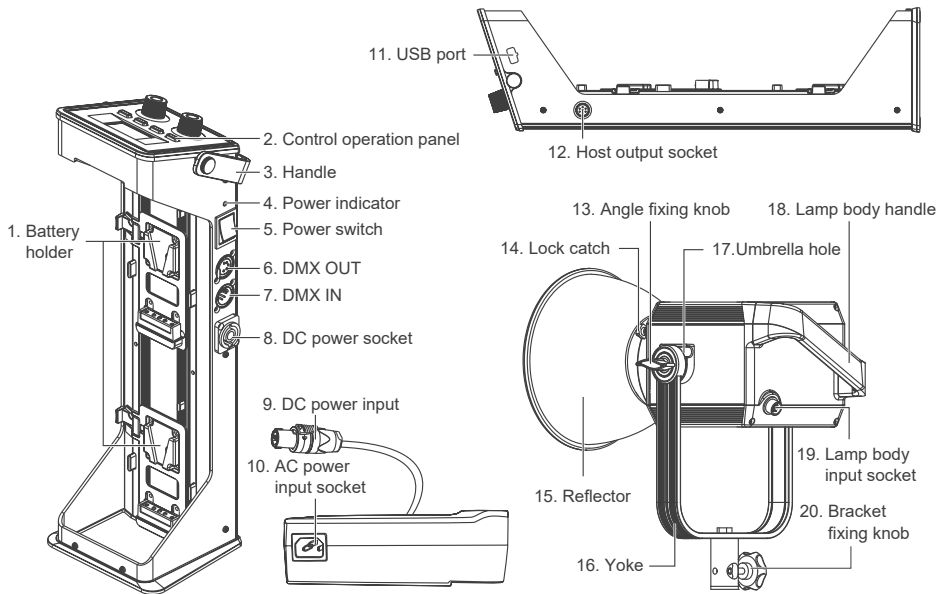

## Detailed Description

1. Battery holder: For installing the battery with two 14.8V/12A Sony V-mount battery or power adapter.
2. Control operation panel: For displaying various functions operations and data.
3. Handle: It is convenient for users to carry the host.
4. Power indicator: For determining the status of power input. Being on, power supply is normal. Flashing or being off, power supply is abnormal or no power input.
5. Power switch: For on/off the fixture.
6. DMX OUT: DMX signal output interface.
7. DMX IN: DMX signal input interface.
8. DC power socket: DC power output.
9. DC power input: For connecting DC power to the lamp.
10. AC power input socket: For connecting the AC power cable to supply power to the adapter.
11. USB port: For updating the firmware.
12. Host output socket: To connect a DC cable for connecting between the lamp body and controller.
13. Angle fixing knob: Allows for vertical adjustments and fixing of the lamp.
14. Lock catch: For installing and disassembling reflector and other accessories.
15. Reflector: For gathering light to improve the central illumination.
16. Yoke: Designed for connecting the lamp to the light stand and adjusting the beam angle.
17. Umbrella hole: For installing/removing an umbrella.
18. Lamp body handle: Be convenient for users to lift the lamps and adjust the direction of the light.
19. Lamp body input socket: For connecting the lamp with power adapter.
20. Bracket fixing knob: For connecting the spot light and camera equipment , and adjusting the horizontal illumination direction of fixture.

## Usage

### 1. Connection between the light fixture and battery

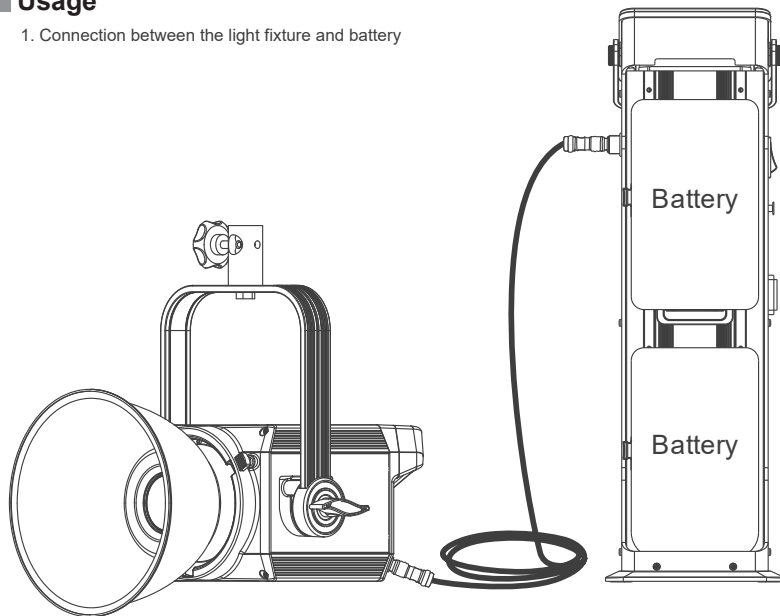

▲ Note: When use the V mount battery, please make sure to turn off the fixture and then plug in or pull out the battery or DC cable.

## 2. Connection between the light fixture and power adapter

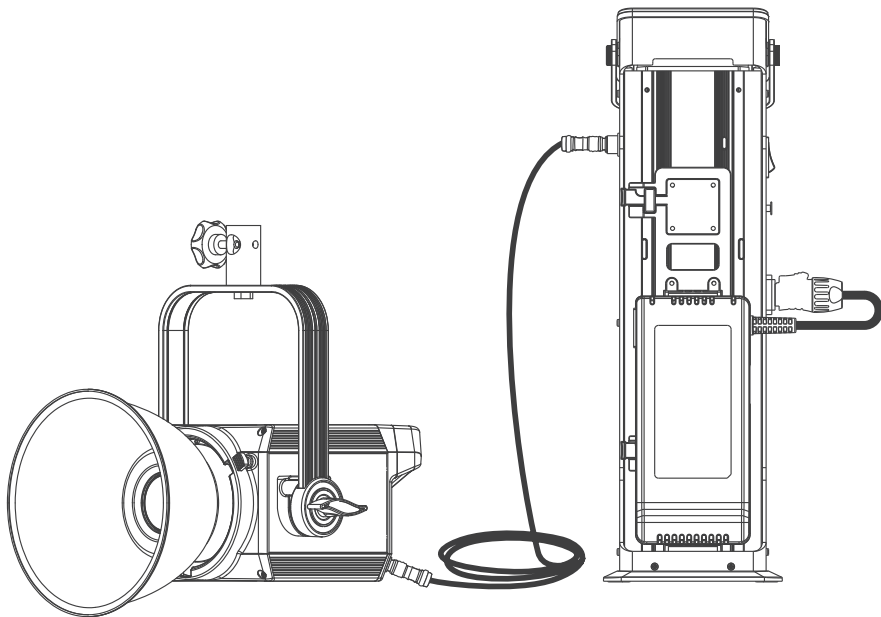

- ▲ Note: (1) When connect the power supply, please make sure the power and voltage should be consistent with the provide power supply.
- (2) Make sure to use the provided power cable and power adapter, the plug or power supply and the cable to the socket of the fixture should be connected as following.

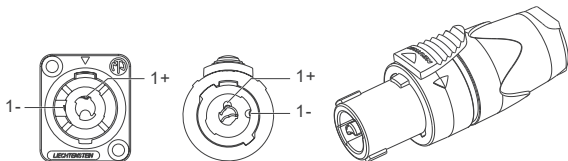

- Pin1 +: Connect with power supply +  
 Pin1 -: Connect with power supply -  
 Pin2 +: Connect with switch  
 Pin2 -: Connect with switch

### 3. Installation of the Reflector

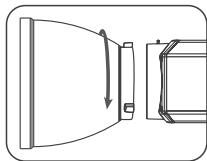

When installing the reflector, ensure its mounting points align with the slots on the light fixture. When the mounting points and slots are aligned push the reflector in place and rotate it in the direction shown on the light until you hear it click into place.

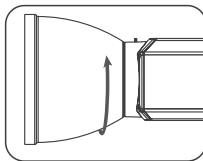

When removing the reflector, push and hold the release button and rotate until the reflector is free to be removed from the fixture.

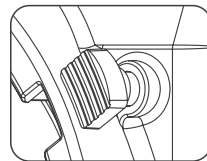

Press the release button to remove the reflector.

4. Installation of the Light Stand Clamp

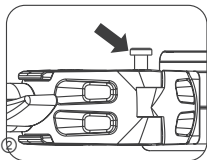

Push in the button to open the clamp.

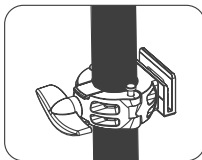

Secure the clamp on the light stand and rotate the locking knob to secure.

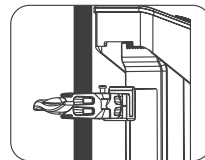

Mount the power adapter into the slot on the clamp.

5. Installation of an Umbrella

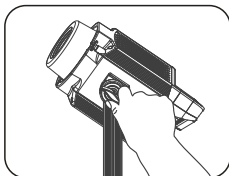

Loosen the angle fixing knob.

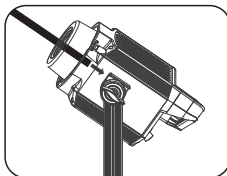

Put the umbrella into the umbrella hole.

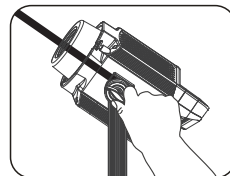

Tighten the angle fixing knob to lock the umbrella in place.

## Remote Control

· Forza 300B supports remote control via DMX, 2.4G, RDM, and has built-in bluetooth.

1. ADDRESS/DMX, including ADDRESS and DMX MODE settings.

### ①ADDRESS

Press the "MENU" Key to access options.

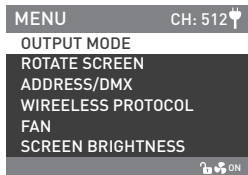

left knob



right knob



CCT



EFFECT



MENU

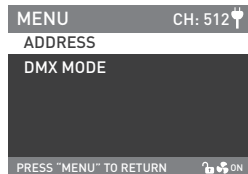
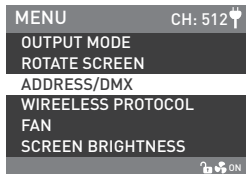

Rotate the "right knob" to ADDRESS/DMX and press in the "right knob" to enter the corresponding secondary menu.

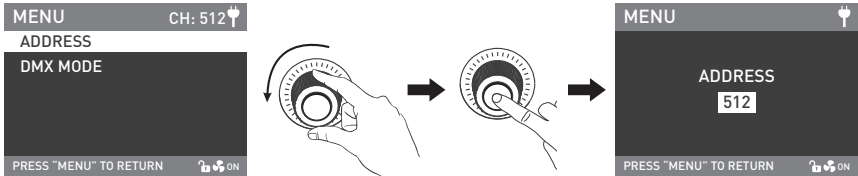

Rotate the "right knob" to the ADDRESS and press in the "right knob" to enter the corresponding third menu.

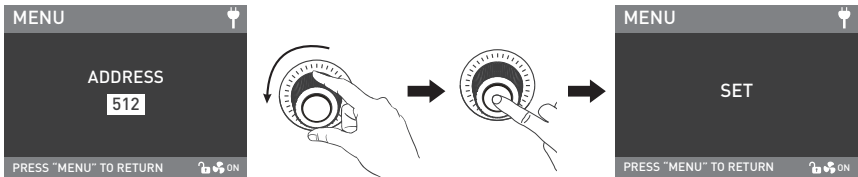

Rotate the "right knob" to select the desired ADDRESS number and press in the "right knob" to set.

Note: 1. The ADDRESS needs to be set before operating the remote control by DMX,2.4G and RDM.

2. Forza 300B has 11 channels, for multiple lights controlled remotely, the address of the first light is set to 001, the second one is 012, the third one is 023 and so on.



②DMX MODE

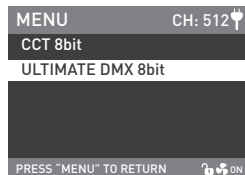
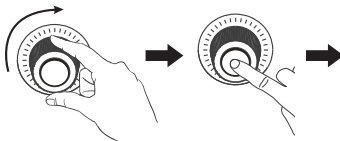
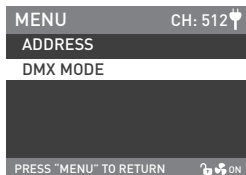

Rotate the "right knob" to the DMX MODE and press in the "right knob" to enter the corresponding secondary menu.

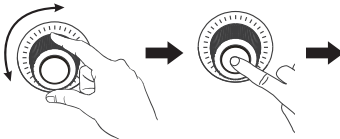
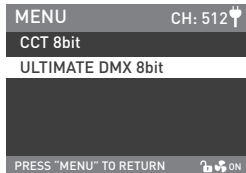

Rotate the "right knob" to select the CCT 8bit or ULTIMATE DMX 8bit and press in the "right knob" to set.

## 2. DMX Remote Control

① Connect the light fixture to the DMX512 console with a connection cable in the following way:



· The connection between the light fixture and DMX512, light fixture and light fixture should use five core shielded cable and make sure its diameter is not less than 0.3mm. XLR plug/socket and the wire should be connected as the picture above.

· Pin1, Pin2, Pin3 for connecting DMX signal, Pin4, Pin5 is connectionless.

▲ Note: When connect with socket, make sure the internal pin not be in contact with the inner case. The fixture can match the the DMX512 (1990) control signal.

· Plug of five-core and three-core XLR plug/socket conversion.

The fixture comes with five-core XLR plug. If you use the three-core XLR plug, kindly follow below instruction.

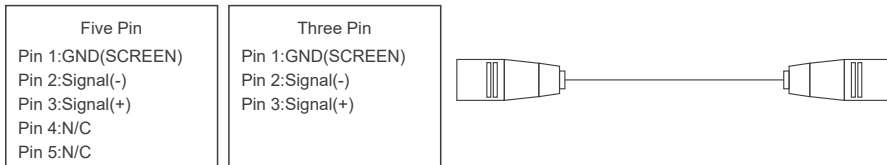

## ②DMX Circuit

In DMX mode, make sure the last light is the only light with a cable connected to DMX output. There is a resistance about 120(OHM) between the second pin and third pin of this plug (as shown). Make sure this plug can be installed into the output of the last fixture, this will help avoid noise and reflection phenomenon caused by the DMX signal during the transmitting process.

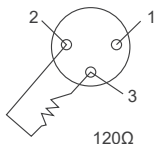

DMX circuit connection  
Connect a 120(OHM) resistance  
between the 2pin and 3pin of the  
XLR plug and then connect it to the  
DMX output socket of the last fixture.

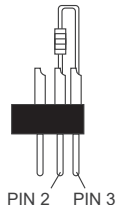

③Set the address of the DMX512 console to be consistent with the light fixture.

④Refer to the attached DMX channel list and control the light via DMX512. (For specific operation methods, please refer to the DMX512 console operation manual.)

Note: DMX Channel List 《 Forza 300B DMX REFERENCE GUIDE 》 please download it from [www.nanlite.com](http://www.nanlite.com)

## 3. 2.4G Remote Control

Set the address of the 2.4G remote controller to be consistent with the light fixture, then the light fixture can be remotely controlled by the WS-RC-C2 remote controller or by APP via the transmitter box.

Note: ① 2.4G remote controller and Transmitter Box are sold separately.

- ② The fixture supports the 2.4G wireless protocol V1.0 and V2.0. Set fixture to V2.0 while using WS-RC-C1 or WS-RC-C2 remote controller. Set fixture to V1.0 while using other remote controllers.  
(See the operation on the manual of P33.)

#### 4. RDM Remote Control

- ① Connect the light fixture to the console with RDM function with a connection cable, the connection method is the same as the DMX512 console.
- ② Set the address of the RDM console to be consistent with the light fixture.
- ③ Refer to the attached DMX channel list and control the light via RDM console. (For specific operation methods, please refer to the RDM console operation manual.)

## Operating Instructions

### 1. Connection between fixture and power adapter/battery.

- ① First, be sure that the power switch of the control unit is in the "off" position. Now it is safe to connect the power adapter or batteries and power the unit on. If the power indicator is on that means the power supply is normal, the screen will display all the relevant information for the fixture. If powered by battery, the remaining battery power will be showed in top right corner.

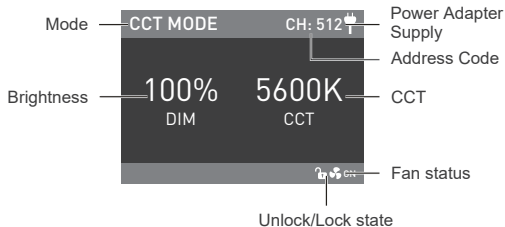
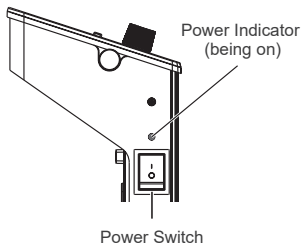

### 2. CCT Key: Press the CCT Key to enter CCT MODE.

- ① DIM setting: Rotate the "left knob", clockwise to increase the brightness while counterclockwise to reduce the brightness. The screen shows the percentage of brightness, DIM range: 0%-100%.

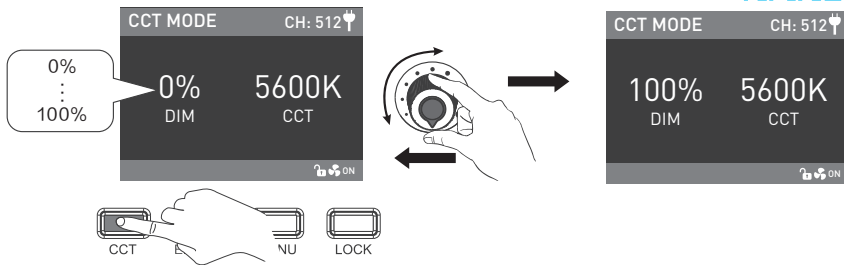

Note: In other modes, DIM range is the same as the CCT MODE. When the light function is unlocked, in any modes, press in the "left knob", the light will off and the brightness shown on the screen is 0%. Press in again to restore the previous states. Press in continuously to switch between on and off.

② CCT setting: Rotate the "right knob", clockwise to increase the color temperature while counterclockwise to reduce the temperature. The screen shows the value of CCT, CCT range of 2700K-6500K.

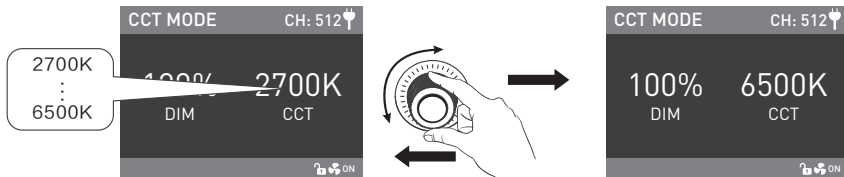

Note: In other modes, CCT range is the same as the CCT MODE, press in the "right knob" can circularly select the CCT in 2700K, 3200K, 4300K, 5600K and 6500K.

3. EFFECT Key: Press in the EFFECT Key to enter EFFECT MODE.

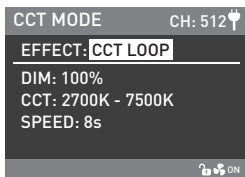

left knob



right knob

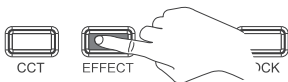

Forza 300B has built-in effects: CCT LOOP, INT LOOP, FLASH, PULSE, STORM AUTO, STORM MANUAL, TV, PAPAZZI, CANDLE/FIRE, BAD BULB, FIREWORK, EXPLOSION AUTO, EXPLOSION MANUAL and WELDING.

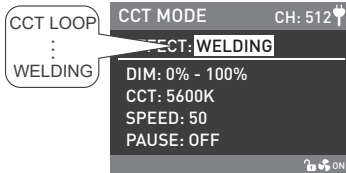
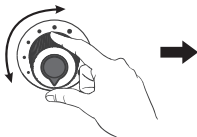
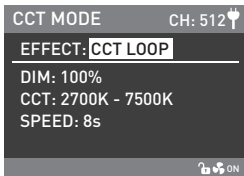

Rotate the "left knob" to select the special effect circularly.

## ① CCT LOOP

CCT LOOP setting: rotate the "right knob" to select DIM, CCT and SPEED (Range 2s-30s), then rotate the "left knob" to set the parameters of the corresponding options.

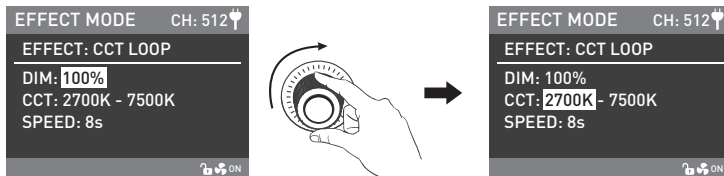

Rotate the "right knob" to select DIM, CCT and SPEED.

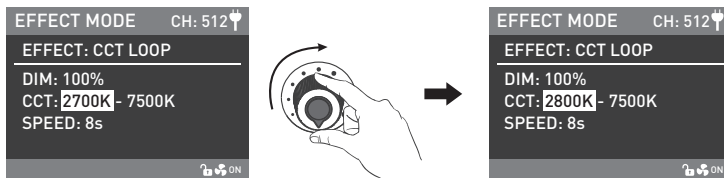

Rotate the "left knob" to set the parameters of the corresponding options.

②INT LOOP

INT LOOP setting: rotate the "right knob" to select DIM, CCT and SPEED (Range 2s .. 30s), then rotate the "left knob" to set the parameters of the corresponding options.

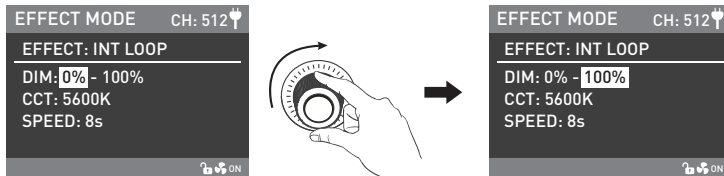

Rotate the "right knob" to select DIM ,CCT and SPEED.

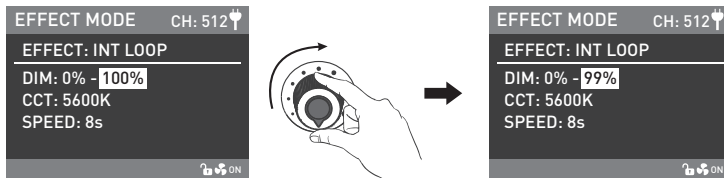

Rotate the "left knob" to set the parameters of the corresponding options.



## ③FLASH

FLASH setting: rotate the "right knob" to select DIM, CCT, INTERVALS (Range: 0.1s..10.0s) and FLASH RATIO (Range: 0% .. 100%), then rotate the "left knob" to set the parameters of the corresponding options.

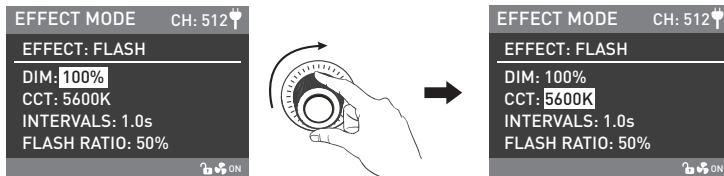

Rotate the "right knob" to select DIM, CCT, INTERVALS and FLASH RATIO.

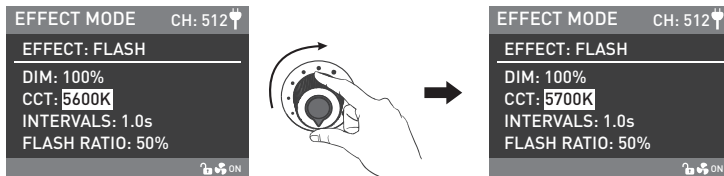

Rotate the "left knob" to set the parameters of the corresponding options.

## ④PULSE

PULSE setting: rotate the "right knob" to select DIM, CCT and PULSES/MIN (Range: 1...240), then rotate the "left knob" to set the parameters of the corresponding options.

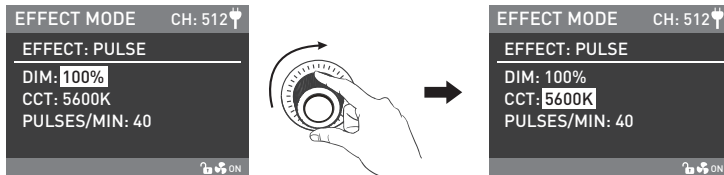

Rotate the "right knob" to select DIM, CCT and PULSES/MIN.

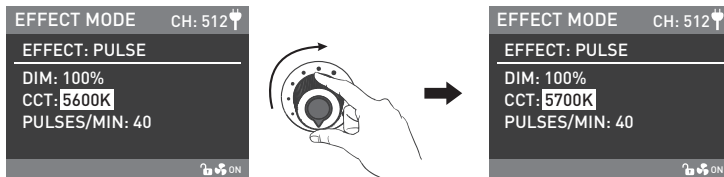

Rotate the "left knob" to set the parameters of the corresponding options.

## ⑤ STORM AUTO

STORM AUTO setting: rotate the "right knob" to select DIM,CCT and INTVL RANGE (Range: 1s ... 60s) , then rotate the "left knob" to set the parameters of the corresponding options.

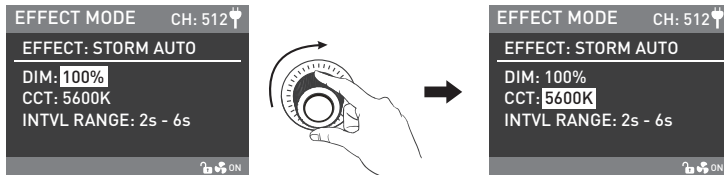

Rotate the "right knob" to select DIM,CCT and INTVL RANGE.

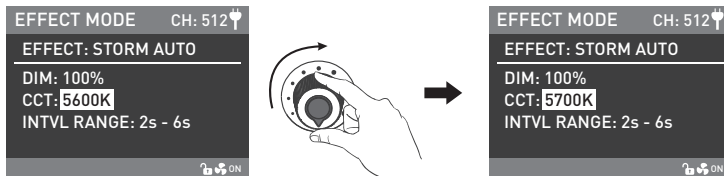

Rotate the "left knob" to set the parameters of the corresponding options.

⑥ STORM MANUAL

STORM MANUAL setting: rotate the "right knob" to select DIM and CCT, then rotate the "left knob" to set the parameters of the corresponding options. Press "right knob" to trigger Storm.

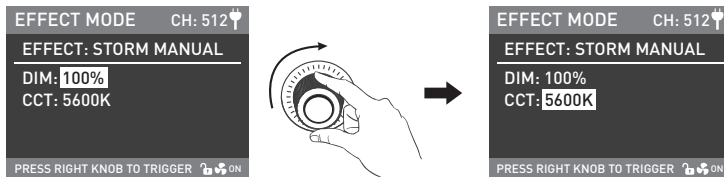

Rotate the "right knob" to select DIM and CCT.

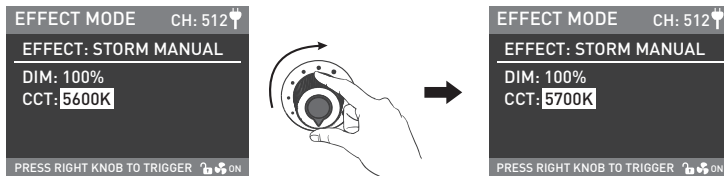

Rotate the "left knob" to set the parameters of the corresponding options.

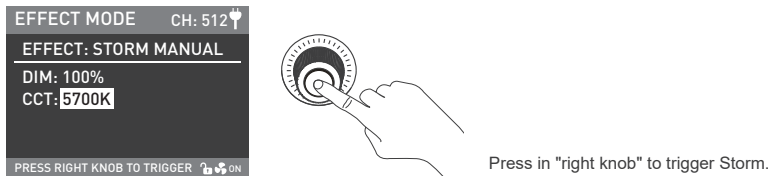

Press in "right knob" to trigger Storm.

## ⑦TV

TV setting: rotate the "right knob" to select DIM, CCT, CCT SHITF (Range: 0K...3000K) and SPEED (Range: 1...100), then rotate the "left knob" to set the parameters of the corresponding options.

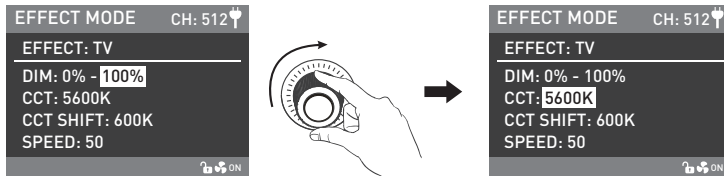

Rotate the "right knob" to select DIM, CCT, CCT SHITF and SPEED.

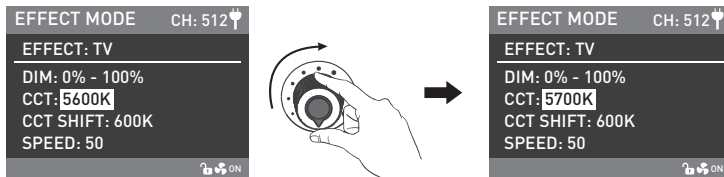

Rotate the "left knob" to set the parameters of the corresponding options.

⑧PAPARAZZI

PAPARAZZI setting: rotate the "right knob" to select DIM, CCT and SPEED (Range:1...100), then rotate the "left knob" to set the parameters of the corresponding options.

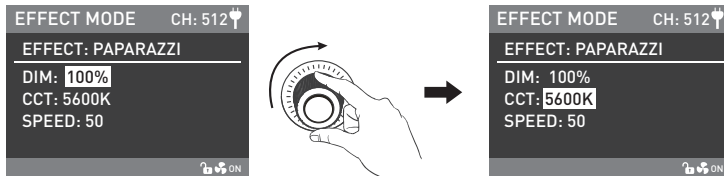

Rotate the "right knob" to select DIM, CCT and SPEED.

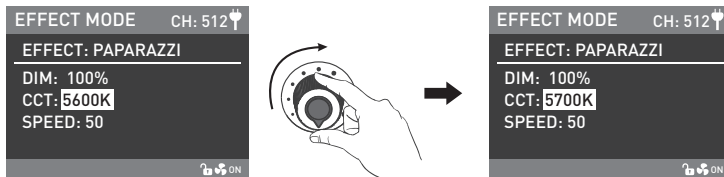

Rotate the "left knob" to set the parameters of the corresponding options.

## ⑨ CANDLE/FIRE

CANDLE/FIRE setting: rotate the "right knob" to select DIM, CCT and SPEED (Range: 1...100), then rotate the "left knob" to set the parameters of the corresponding options.

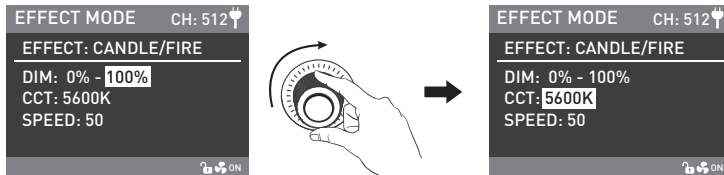

Rotate the "right knob" to select DIM, CCT and SPEED.

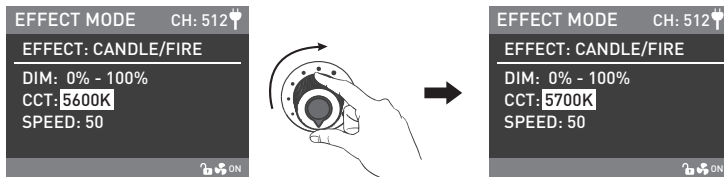

Rotate the "left knob" to set the parameters of the corresponding options.

## ⑩BAD BULB

BAD BULB setting: rotate the "right knob" to select DIM, CCT, INTENSITY (Range: 1...100) and SPEED (Range: 1...100), then rotate the "left knob" to set the parameters of the corresponding options.

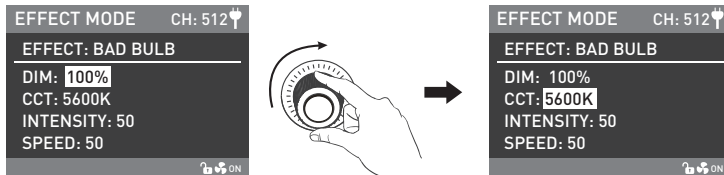

Rotate the "right knob" to select DIM, CCT, INTENSITY and SPEED.

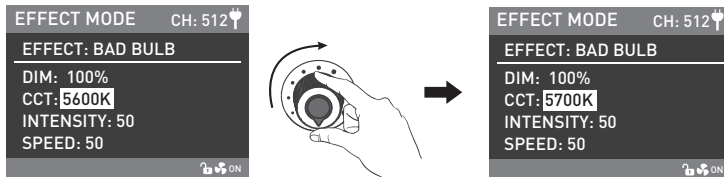

Rotate the "left knob" to set the parameters of the corresponding options.



⑪ FIREWORK

FIREWORK setting: rotate the "right knob" to select DIM ,CCT, SPEED (Range: 1...100) and DECAY(Range: 1... 100), then rotate the "left knob" to set the parameters of the corresponding options.

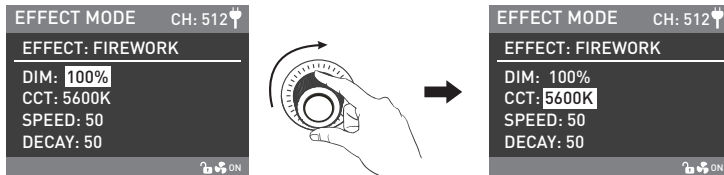

Rotate the "right knob" to select DIM ,CCT, SPEED and DECAY.

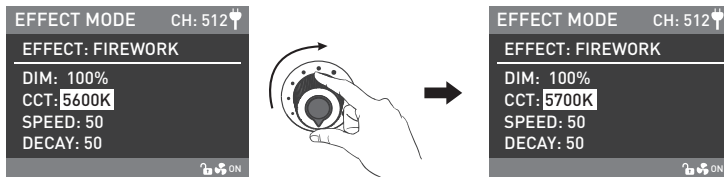

Rotate the "left knob" to set the parameters of the corresponding options.

## ⑫ EXPLOSION AUTO

EXPLOSION AUTO setting: rotate the "right knob" to select DIM, CCT, SPEED (Range: 1...100) and DECAY (Range: 1...100), then rotate the "left knob" to set the parameters of the corresponding options.

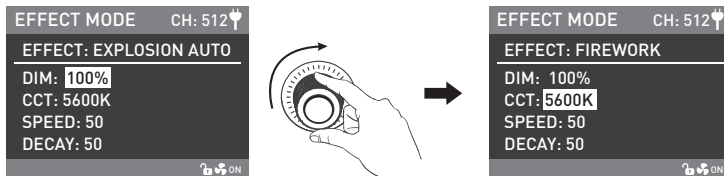

Rotate the "right knob" to select DIM, CCT, SPEED and DECAY.

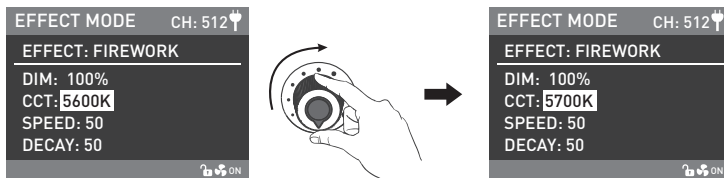

Rotate the "left knob" to set the parameters of the corresponding options.

⑬ EXPLOSION MANUAL

EXPLOSION MANUAL setting: rotate the "right knob" to select DIM, CCT and DECAY (Range 1...100), then rotate the "left knob" to set the parameters of the corresponding options.

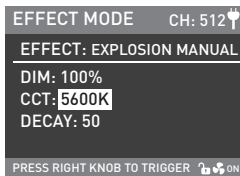
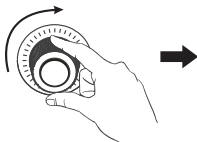
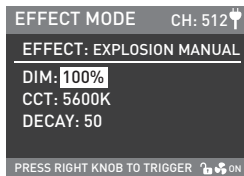

Rotate the "right knob" to select DIM, CCT and DECAY.

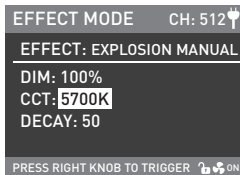
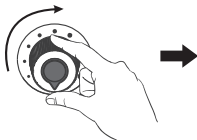
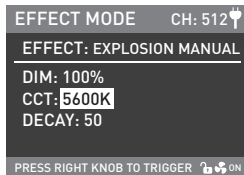

Rotate the "left knob" to set the parameters of the corresponding options.

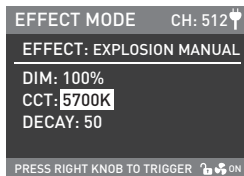

Press "right knob" to trigger the Explosion.

⑭ WELDING

WELDING setting: rotate the "right knob" to select DIM, CCT, SPEED (Range: 1...100) and PAUSE (ON/OFF), then rotate the "left knob" to set the parameters of the corresponding options.

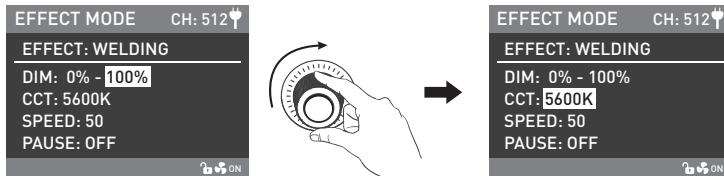

Rotate the "right knob" to select DIM, CCT, SPEED and PAUSE.

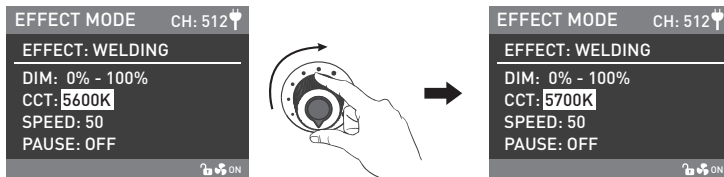

Rotate the "left knob" to set the parameters of the corresponding options.

NOTE: When the PAUSE is on , WELDING will pause.

·Lighting effects and additional functionality maybe added with future firmware releases, for details of these please see [www.nanlite.com](http://www.nanlite.com).

4. MENU Key: Press the MENU key to enter the interface of menu, the menu includes DIM OUTPUT, ROTATE SCREEN, ADDRESS/DMX, WIRELESS CONTROL, FAN, SCREEN BRIGHTNESS, BUTTON BACKLIGHT, LANGUAGE and VERSION.

The operation of the menu:

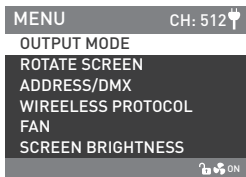

left knob



right knob

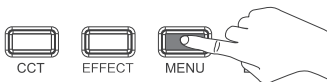

- Rotate the "right knob" to select the desired option, press in the "right knob" to enter the corresponding secondary menu, then rotate the "right knob" to select the corresponding options, finally press in the "right knob" to set. Press the MENU key to return to the previous menu.

① OUTPUT MODE

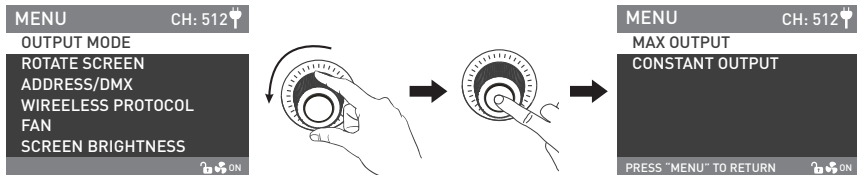

Rotate the "right knob" to the DIM OUTPUT and press in the "right knob" to enter the corresponding secondary menu.

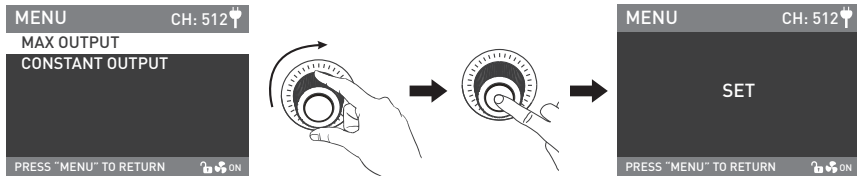

Rotate the "right knob" to select the MAX OUTPUT or CONSTANT OUTPUT and press in the "right knob" to set.

② ROTATE SCREEN

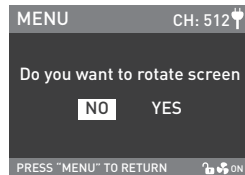
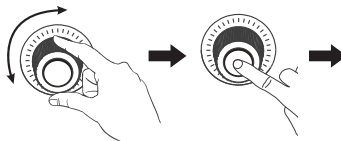
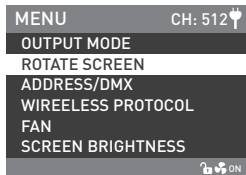

Rotate the "right knob" to the ROTATE SCREEN and press in the right knob to enter the corresponding secondary menu

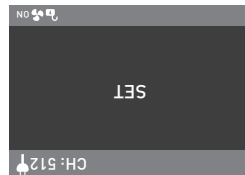
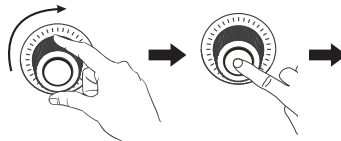
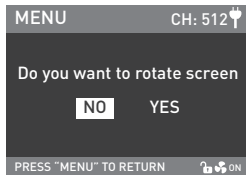

Rotate the "right knob" to select the YES or NO and press in the "right knob" to set.

③ ADDRESS/DMX

For details please refer to P8 for remote control.

## ④ WIRELESS PROTOCOL

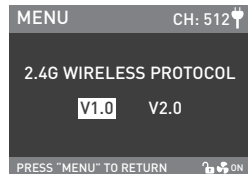
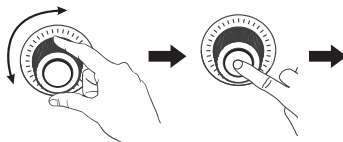
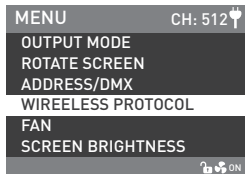

Rotate the "right knob" to the WIRELESS PROTOCOL and press in the "right knob" to enter the corresponding secondary menu.

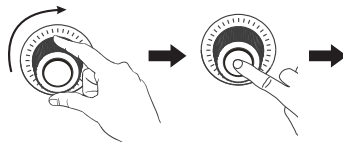
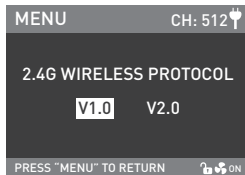

Rotate the "right knob" to select the V1.0 or V2.0 and press in the "right knob" to set.

Note: Forza 300B supports V1.0 and V2.0 wireless protocol, when using the WS-RC-C2 for remote control, the wireless protocol should be set to V2.0 and set to V1.0 while using other remote controllers.

(See operation guide on P33 of the manual.)



⑤ FAN

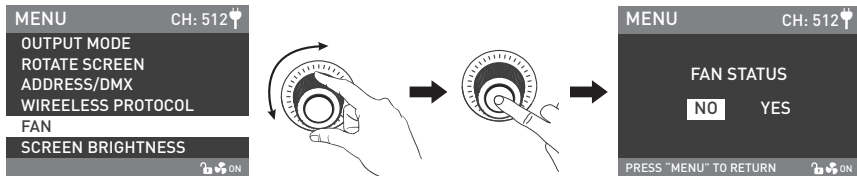

Rotate the "right knob" to the FAN and press in the "right knob" to enter the corresponding secondary menu.

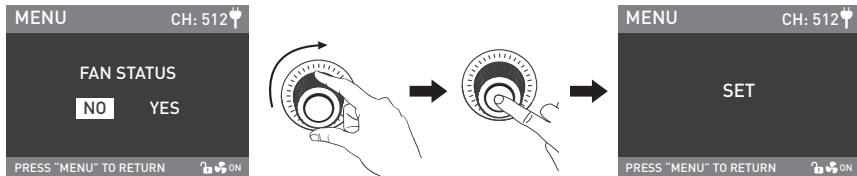

Rotate the "right knob" to select the ON or OFF and press in the "right knob" to set.

- When the fan is in the "OFF" position, the inside fan will stop working, when activated the maximum output of the light will be 15%, when the fan is in the "ON" position, the maximum output of the light will be 100%.

## ⑥ SCREEN BRIGHTNESS

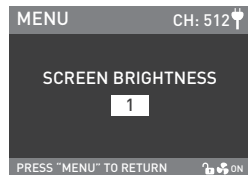
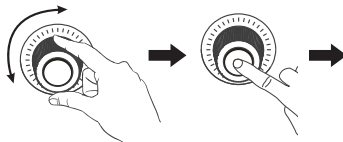
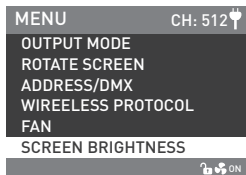

Rotate the "right knob" to the SCREEN BRIGHTNESS and press in the "right knob" to enter the corresponding secondary menu.

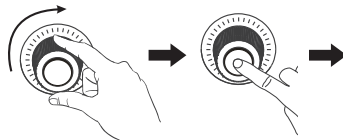
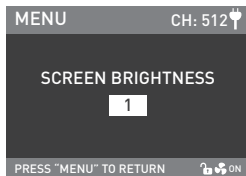

Rotate the "right knob" to select the SCREEN BRIGHTNESS and press in the "right knob" to set.

## ⑦BUTTON BACKLIGHT

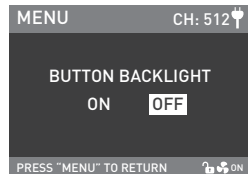
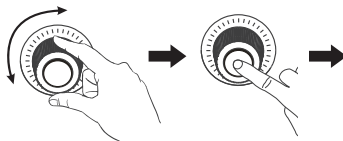
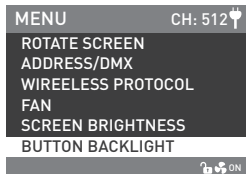

Rotate the "right knob" to the BUTTON BACKLIGHT and press in the "right knob" to enter the corresponding secondary menu.

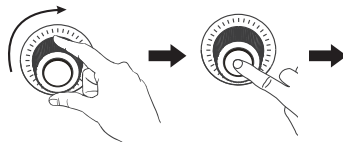
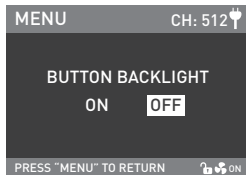

Rotate the "right knob" to select the ON or OFF and press in the "right knob" to set.

## ⑧LANGUAGE

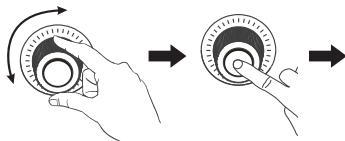
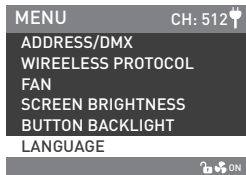

Rotate the "right knob" to the LANGUAGE and press in the "right knob" to enter the corresponding secondary menu.

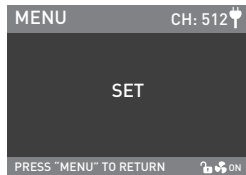
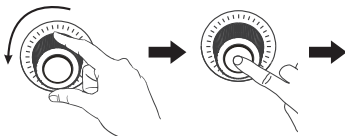

Rotate the "right knob" to select the ENGLISH or 简体中文 and press in the "right knob" to set.

⑨VERSION

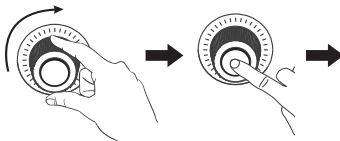
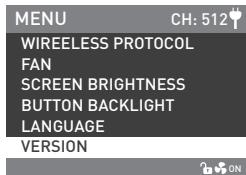

Rotate the "right knob" to the VERSION, and press in the "right knob" to check the current version.

5. Lock Key: Long press the "Lock Key" for 2 seconds to lock all functions, now operation key or adjustment knobs cannot change the current function, long press the Lock key for 2 seconds again to release the Lock status.

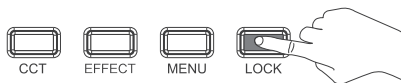
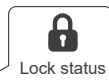
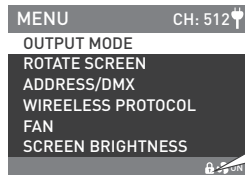
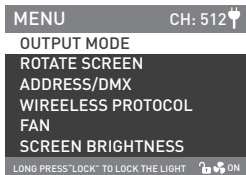

6. When stop using the fixture, please turn off the switch







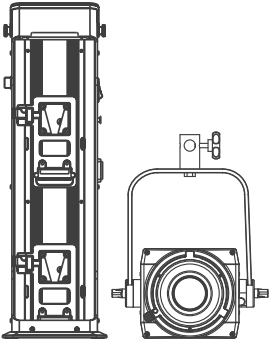

## Safety Precautions

1. Please open the package to check for damage caused in transit, if damaged please do not use and contact place of purchase or manufacturer as soon as possible.
2. Do not use a power cord with damaged insulation. Do not unplug hard or drag the power cord directly.
3. Make sure that the power supply voltage used matches the voltage specified by the light before installation.
4. When not using or cleaning the light, please turn it off.
5. Keep the light safely stored and away from children.

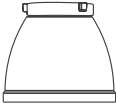
## Notice

1. When the light is on do not look directly at the emitter.
2. Do not place objects on the light emitter or allow liquid to flow inside the fixture or the emitter.
3. Do not place the fixture near flammable substances like alcohol or gasoline.
4. When cleaning the light, please wipe off debris or dirty by using a cloth with clean water or neutral cleanser.
5. The Forza 300B should be safely operated where it won't be at risk of getting wet or under extreme temperatures. Please make sure the ventilation fan is not blocked or obstructed.
6. Do not attempt to repair the Forza 300B by yourself. Attempts to self repair will void warranty, for repairs please return to place of purchase.
7. For optimal cooling of the fixture, the vents should not be covered when using, or will damage the equipment. When using the lighting for a long time, the temperature of the lighting is high, please pay attention to anti-scalding.

## What's in the box? Please kindly check

<p>Forza 300B x 1</p>	<p>Light Stand Clamp x 1</p>	<p>Reflector x 1</p>	
			
	<p>Power Cable 3M x 1</p>	<p>DC Connecting Cable 2.5M x 1</p>	<p>Power adapter x 1</p>
			
<p>Carrying bag x 1</p>	<p>User Manual x 1</p>	<p>DMX Reference Guide x1</p>	
			

## General Fault Detection and Diagnosis

Fault Detection	Diagnosis
The light won't start up.	<ol style="list-style-type: none"> <li>1. Please check the power indicator. If flashing or not on, please check whether the connection between power adapter, power cable and outlet connection is properly connected.</li> <li>2. Please check whether the voltage value of power adapter is within specified parameters.</li> <li>3. If using a battery, check if the battery is installed properly, and if the voltage value of battery is within specified parameters.</li> </ol>
The fixture produces light, but the controls are not working.	<ol style="list-style-type: none"> <li>1. Please check to see if the address code corresponds with remote or app.</li> <li>2. Please check and see if the XLR cable is connected properly or if the line of port is damaged.</li> </ol>
LCD display is on but no light output.	<ol style="list-style-type: none"> <li>1. COB or main board may be damaged.</li> <li>2. Check connection of cable from lamp to adapter.</li> </ol>
The inside fan can not work.	<p>If the LED screen displays "LIGHT IS OVERHEATED, ONLY WORKING AT 15% BRIGHTNESS, PLEASE CHECK THE FAN AND SURROUDINGS", please get in contact with place of purchase or Nanlite.</p>
<p>If the failure is not resolved after troubleshooting, please contact place of purchase.</p>	

This manual and all stats within it were produced under controlled conditions, and are accurate at time of print. Any future changes to design/technical data can be found at [www.nanlite.com](http://www.nanlite.com).



Version: V3 2021-04-29

**NANLITE**

 +86-754-85751187

 +86-754-85300887

 [service@nanlite.com](mailto:service@nanlite.com)

 Zhanglin,324,Dongli Chenghai Shantou Guangdong China

[www.nanlite.com](http://www.nanlite.com)