







ASSEMBLY INSTRUCTION

ITEM: 6015-75203B-02 Rattan Round Dining Table Base
 6015-75203B-80 Rattan Round Dining Table Base
 6015-75203B-89 Rattan Round Dining Table Base
 6015-75203T-02 48in Round Dining Table Top
 6015-75203T-80 48in Round Dining Table Top
 6015-75203T-89 48in Round Dining Table Top
 6015-75213T-02 60in Round Dining Table Top
 6015-75213T-80 60in Round Dining Table Top
 6015-75213T-89 60in Round Dining Table Top

Thank you for purchasing this quality product. Be sure to unpack carefully looking for small parts which may have come loose during shipment.
 Read all instruction and study the drawing carefully before starting the assembly process.

HARDWARE PACK

NO.	DRAWING	DESCRIPTION	SIZE	Q'TY	PARTS LIST			
A		Flat Washer	Ø5/16"	4PCS	NO.	DRAWING	DESCRIPTION	Q'TY
B		Lock Washer	Ø5/16"	4PCS	1		Top	1PC
C		Bolt	Ø5/16"	4PCS	2		Base	1PC
D		Allen Wrench	73*29*5mm	1PC				

STEP 1

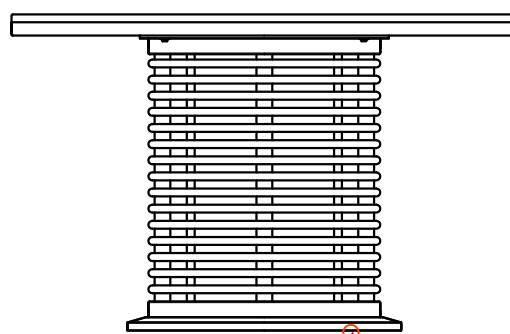
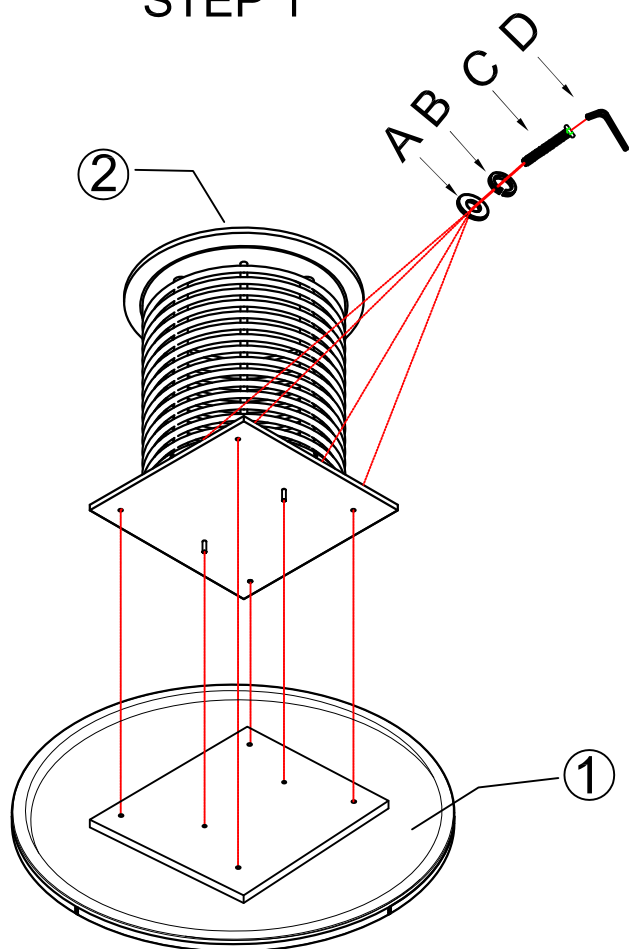

STEP 2

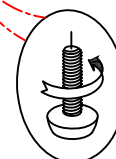

Adjust Leveler if needed to level table on uneven floor.