

SIDES	BOTTOM
Material: Steel-0.236"-C1008~C1018, Zinc plated	

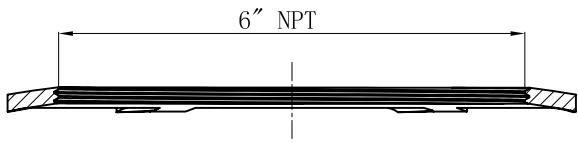

CUTAWAY VIEW A-A

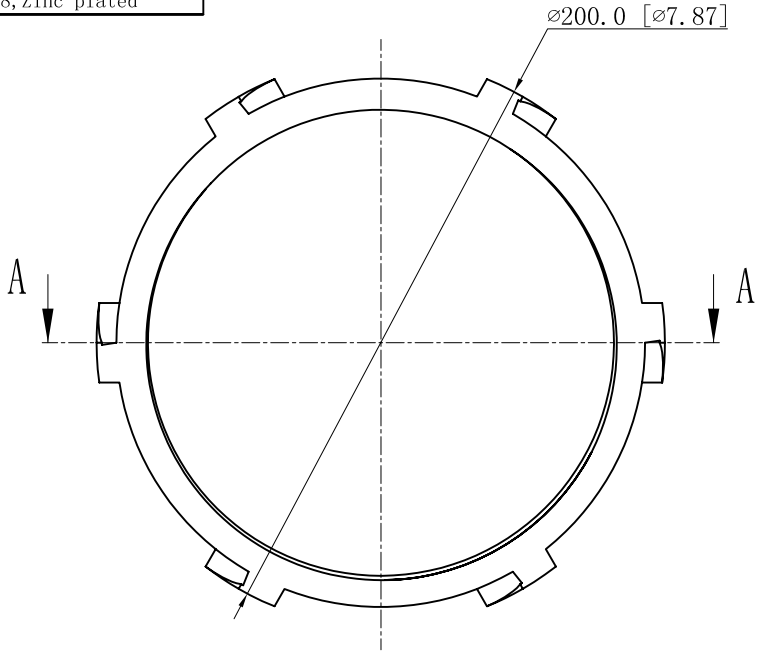
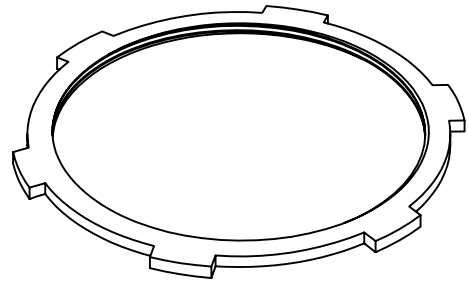

This data sheet is for reference only .GARVIN INDUSTRIES reserves the right to make changes to the design without prior notice.

DESCRIPTION
TRADE REFERENCE TERMS

STANDARD PACKING
5 PCS

GARVIN INDUSTRIES		
TITLE STEEL LOCKNUTS		
SIZE A4	DWG NO. LN-600	REV
DATA SHEET		