

2-TIER SOLAR WATER FOUNTAIN

AMP-F802





Review all assembly and care information before using this product. Save this manual for future reference.

Select a smooth, level surface to place the fountain.

Assemble components on a soft, clean surface to avoid scratching or damaging the finish.

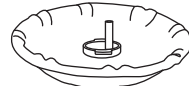

Inspect packaging to ensure all parts are accounted for before disposing of packing materials.
 Save the packing slip.

PARTS		QTY.
	Topper	1
	Top Bowl	1
	Column	1
	Bottom Bowl	1
	Pedestal	1
	Solar Pump & Panel Kit	1



Cascading waterfall sounds



IMPORTANT NOTES:

- The water tubing is built into the fountain topper. Take care when handling the water tube; detaching the water tube from the fountain will damage the unit and void the warranty.
- Rattling noise inside the fountain? Due to the casting process, there may be loose pieces of casting material inside the fountain.
- The solar panel kit may include accessories (extension tubes, spray heads, LED light ring) that are not required for operation of this fountain. Refer to *ASSEMBLY, page 2*, for required components.

WARNING:

Manufacturer and seller expressly disclaim any and all liability from personal injury, property damage or loss, whether direct or indirect, or incidental, resulting from the incorrect attachment, improper use, inadequate maintenance, or neglect of this product.

ASSEMBLY

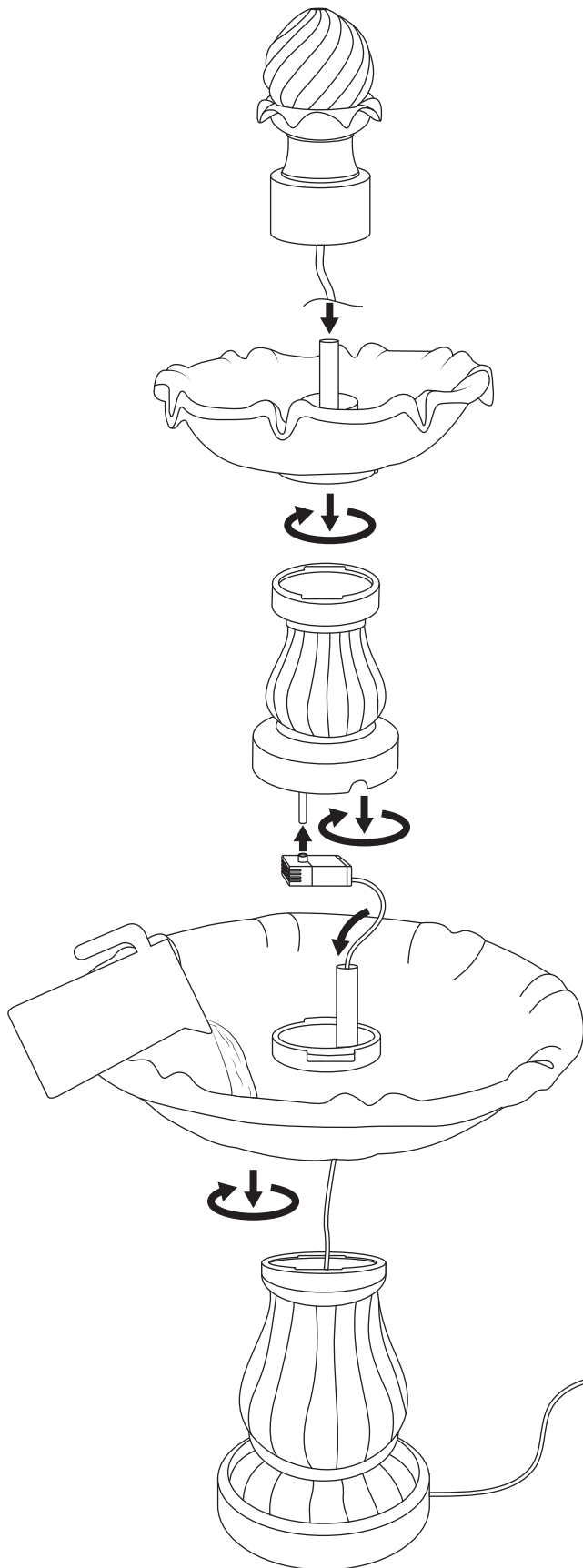

1. Place the bottom bowl onto the pedestal and twist to lock in place.
2. Place the pump in the center of the bottom bowl. Run the power cable through the pipe in the bowl and beneath the groove in the bottom of the pedestal.
3. Place the top bowl onto the column and twist to lock in place.
4. Run the water tube that is built into the topper through the top bowl and column.
5. Taking care not to drop the topper, firmly connect the water tube to the pump.
6. Ensuring the pump is sitting flat inside the bottom bowl, align the column with the bottom bowl, twist to lock in place.
7. Fill each tier with enough water to keep the pump fully submerged during operation.
8. Paying attention to the positive and negative terminals, gently insert the included 'AA' batteries into the back of the solar panel.
9. Plug the power cable into the solar panel.
10. Assemble the solar panel ground stake. Insert the spike into the ground, ensuring the solar panel is positioned for maximum sun exposure.

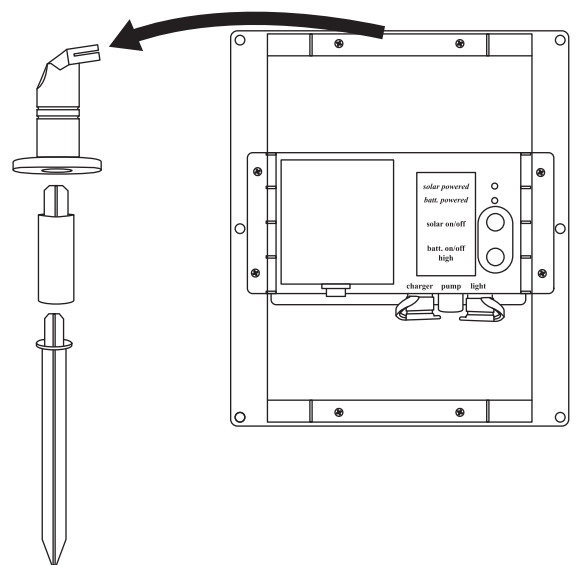
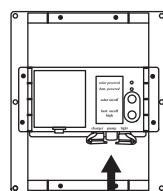

PANEL PLACEMENT

Insert the spike into the ground. Position the solar panel to face south (in the Northern Hemisphere) to make the most of daylight hours. It is important to angle the solar panel towards the sun when the sun is at its highest point. Ensure trees, shrubs, or buildings do not shade the solar panel.

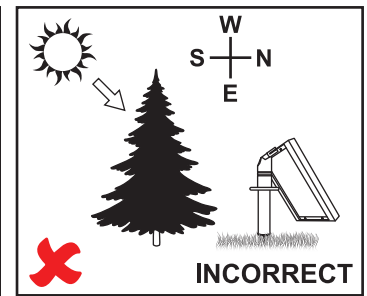
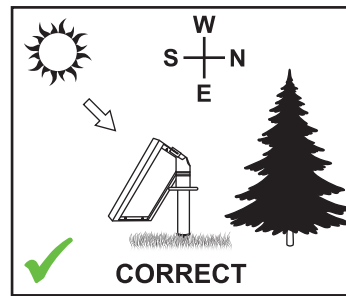

SOLAR PANEL OPERATION

Solar-Powered Mode: Recommended mode for daytime use.

Press the "solar on/off" button. The green indicator light will illuminate when the panel power is on; the pump will only run in bright or good sunlight conditions. On bright sunny days, surplus power will charge the battery. The pump will not work on cloudy days as there is insufficient power to run the pump.





Battery-Powered Mode: Recommended mode for nighttime or a cloudy day.

While the "solar-powered" mode is turned on, press the "Battery on/off" button, the red indicator light will illuminate when this mode is on. This mode allows the pump to continue to operate at nighttime or if a day becomes overcast/cloudy. On bright sunny days, the batteries will fully charge, allowing the pump to run up to 4 hours. On cloudy days the pump will run for significantly less time because the batteries did not receive an adequate charge. The mode will switch to "solar-powered" automatically when battery power is low; "battery-powered" mode must be turned back on manually – *it is not automatic.*

Low Battery: If the red indicator light is blinking, the battery power is low.

Allow the solar panel to recharge the batteries for a minimum of 4 hours in direct sunlight. Do not attempt to repeatedly turn on the "battery-powered" mode until a sufficient charge has been allowed, as doing so will deplete the battery power.

Adjustable Water Rate: While the mode is "battery-powered," the water rate can be adjusted by pressing the "batt. on/off high" button. The water flow will be adjusted higher or lower, once the water flow is at a satisfactory level, stop pressing the button.

WEATHER	PUMP ON Surplus solar energy is charged to back-up battery	PUMP OFF All solar energy is charged to back-up battery
	Solar energy runs the pump and charges the battery. Pump performance is maintained when the clouds pass. Pump runs into the evening/night until the battery is depleted.	Battery should be fully charged in 1 day.
	Solar energy runs the pump and surplus energy is stored in the battery. Performance is maintained when the clouds pass. The pump will only run for a short time in the evening until the battery is depleted.	Battery will take 2 to 3 days to fully charge.
	Pump will only run when there is sufficient power from the battery. Little or no battery charging occurs so pump performance is not maintained or guaranteed.	Battery will take several days to fully charge.
	No solar power is available, the pump will not run and the battery will not charge.	Battery will not charge.

BATTERY INFORMATION

Rechargeable batteries become less efficient with repeated charge and discharge cycles. If you find the batteries appear to be less efficient or do not run as long, try a **boost charge**. To do this, disconnect the pump and light cables from the solar panel for 2 to 3 sunny days to allow for a maximum charge to the batteries. After a boost charge, if the batteries are still not performing to expectations, the lifespan may have been exceeded and they should be replaced. Open the battery cover to replace the (4) AA rechargeable batteries.

IMPORTANT! Only use compatible rechargeable batteries, alternatives may be incompatible which may damage the system and will void the warranty. See contact information under WARRANTY to order the correct replacements; have the product number from the top of this manual available for faster service.

Dispose of the batteries in accordance with local laws and regulations.

Care & Maintenance

- Some climates and weather conditions increase water evaporation, requiring water to be added more frequently. Check water levels during times of high temperatures, wind, and long-term exposure to direct sunlight to ensure the pump remains underwater. The pump is equipped with dry-run technology, the pump will shut off when water is low or runs out.
- Only use water in this fountain. Distilled water will help prevent mineral buildup but is not required. Tap water is okay to use, but avoid heavily chlorinated water as it may damage the fountain finish and the pump.
- Over time, the finish may gradually mellow in color due to sun exposure; this is part of the natural aging process and is not cause for return.
- Periodically change the water to help keep the fountain and pump clean. Remove scale and buildup regularly.
 - DO NOT use harmful additives such as bleach, chlorine, etc.
 - DO NOT use anything that is abrasive to scrub the fountain.
 - DO NOT use a pressure washer to clean the fountain.
- Always disconnect the power supply before cleaning and maintaining the fountain and the circulating pump. Take care when handling the pump; only pick it up by the body of the pump, never the power cable.
- During freezing weather, drain the fountain, disconnect the pump and store indoors; allowing ice to form may damage the fountain in such ways as, but not limited to, fountain cracking, permanent pump and/or solar panel damage.

WARNING: THE ONE-YEAR WARRANTY DOES NOT COVER DAMAGES OR DEFECTS CAUSED BY THE APPLICATION OF CHEMICAL TREATMENTS, PROTECTIVE COATINGS, TOUCH-UP PAINT, OR CLEANING PRODUCTS.

Troubleshooting

- The solar panel must be in a location that receives full sunlight; the pump will not operate if the panel is shaded and the back-up battery is depleted.
- Check the power cable to make sure it is fully inserted into the correct port on the solar panel.
- Ensure that the pump is fully submerged in water. The pump is equipped with dry-run technology, it will not circulate water unless it is completely covered with water. Air may be trapped in the pump, gently tap the pump to release the trapped air.
- Check the pump and fountain tubing for obstructions.
- If water is not flowing evenly from the tiers, ensure the fountain is level. Some components may be slightly uneven due to the moulding process, thin plastic shims (not included) may be needed to even out spacing between the tiers.

SAFETY STATEMENTS & WARNINGS

- For outdoor use only.
- Fountains may splash or leak; always protect surfaces that can be damaged by water. Do not use fountain in areas that can be damaged if water splashes or leaks.
- Do not use high-pressure spray nozzles to fill the fountain as doing so may cause the finish to peel.
- Keep fountain out of reach of children and pets.
- Make sure the power cable is away from traffic areas.
- Keep power cables away from all heat sources. Do not place power cables near high-temperature areas.
- Always unplug the power supply before cleaning and maintaining the fountain and the pump.
- Always empty and store the fountain, pump, and solar panel indoors during freezing weather.

 This product uses rechargeable batteries. When the batteries can no longer be used, they should be removed from the unit and recycled. The batteries must not be incinerated or composted. Recycle batteries in accordance with local laws and regulations.

Any modification to the product or failure to follow recommended care will void the product warranty.

If you experience issues with assembly or the product was damaged during shipping, please contact our customer service team through one of the methods mentioned at the top of page 1. Please have the item number and order information ready to expedite response time.

WARNING:

Manufacturer and seller expressly disclaim any and all liability from personal injury, property damage or loss, whether direct or indirect, or incidental, resulting from the incorrect attachment, improper use, inadequate maintenance, or neglect of this product.