

INSTRUCTIONS

1. Please count and make sure all pieces are present before assembly.
2. The pole pieces are delicate. To prevent damage, do not use excessive force.
3. Assemble crystal puzzle by putting the puzzle pieces together in the order shown below.
4. Missing a piece? Email consumer@ugames.com or call (415) 503-1600 with missing piece number.

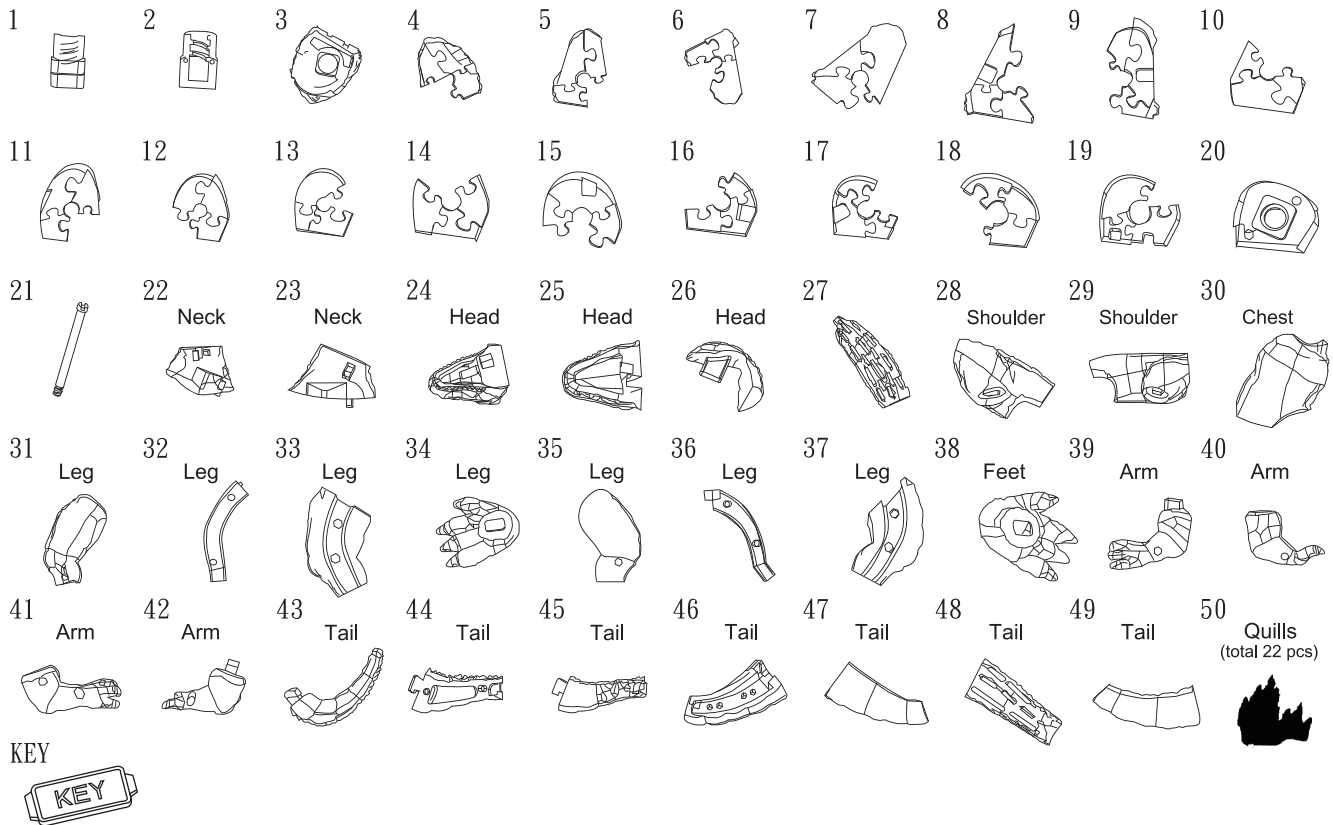

HINTS

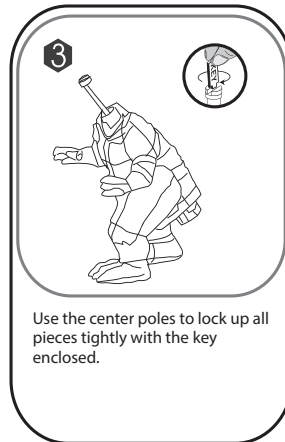
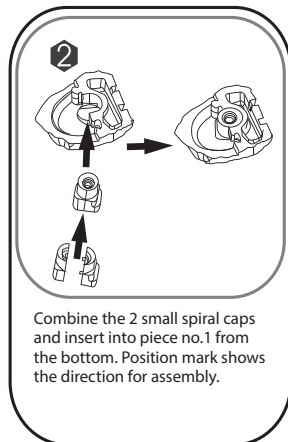

QUILLS LAYOUT

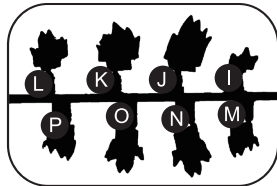
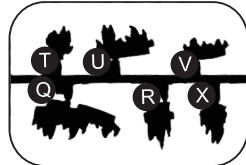
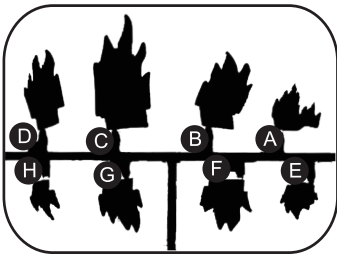

ASSEMBLE ORDER

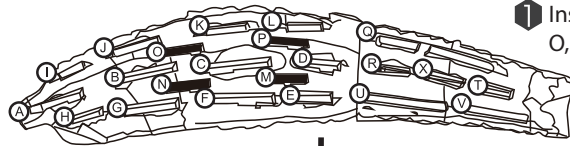

1 Insert quills no. O, P, N, M

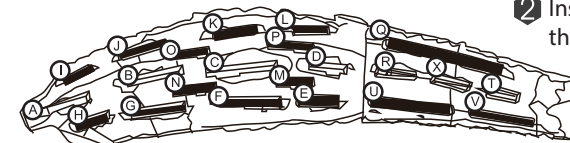

2 Insert all the quills at the periphery

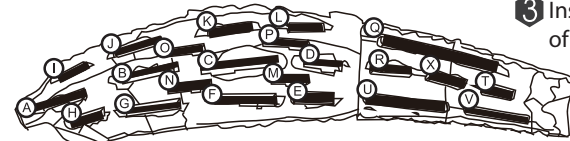

3 Insert all the rest of the quills

TAIL ASSEMBLE ORDER

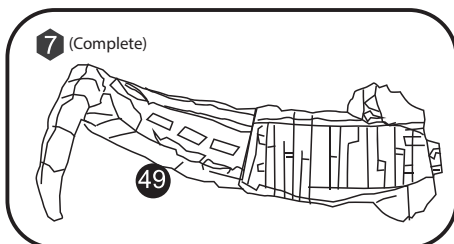
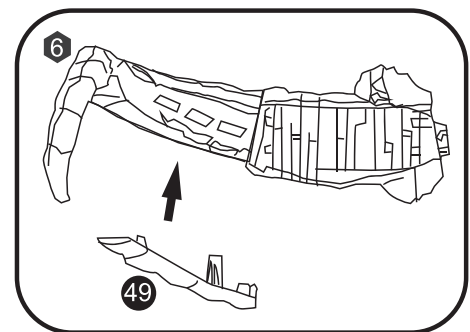
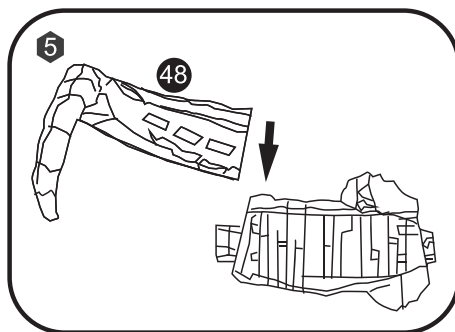
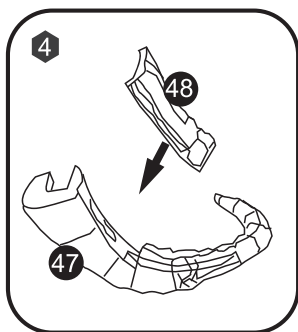
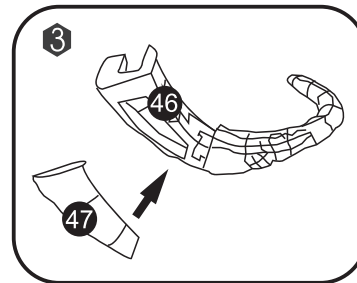
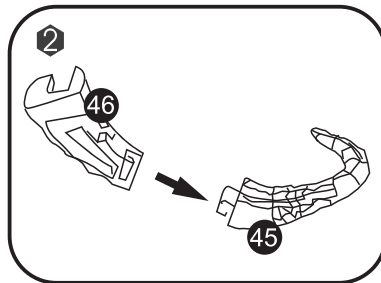
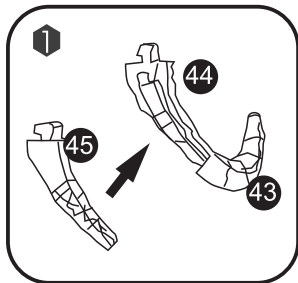

7 (Complete)

