

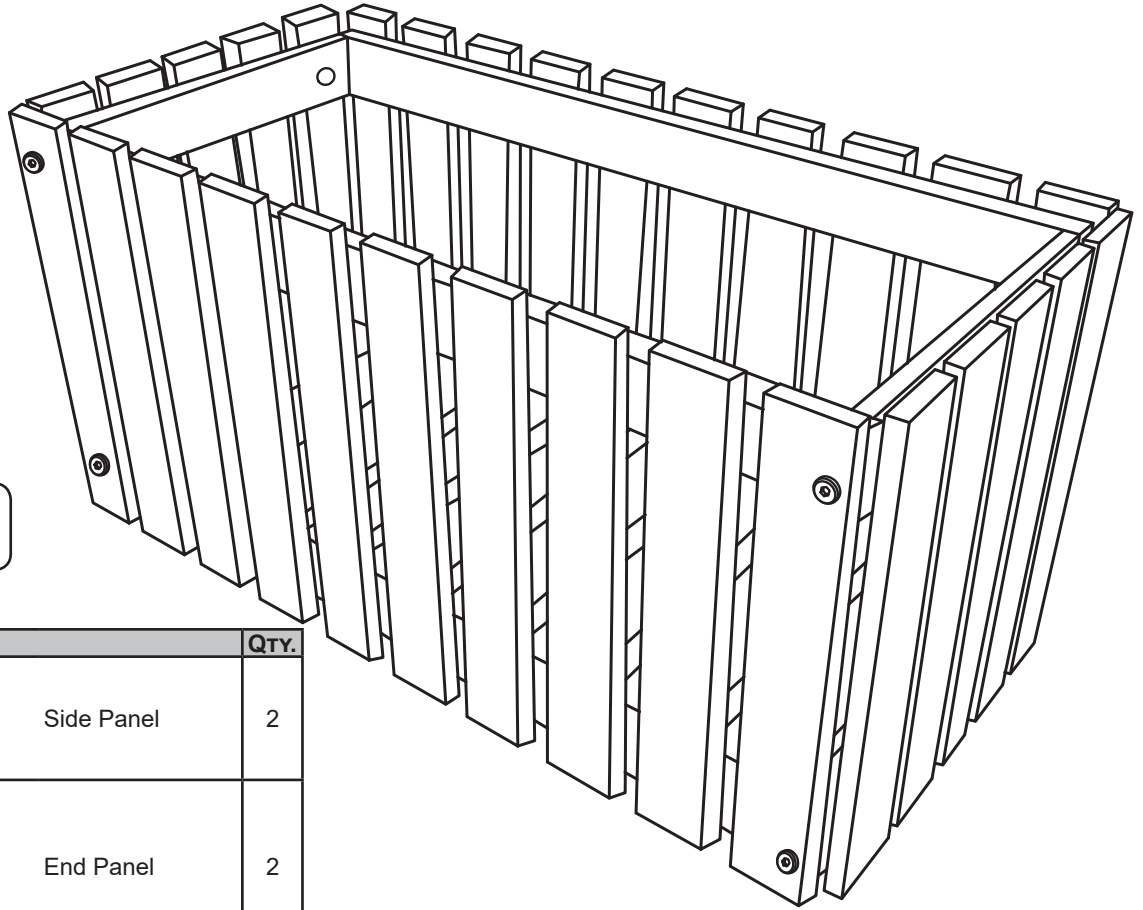

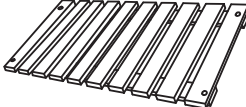

PICKET FENCE STYLE PLANTER BOX LAM-474

Read all assembly and care instructions carefully before using this product. Save this manual for future reference.
Assemble components on a soft, clean surface to avoid damaging the finish.

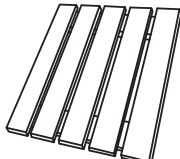
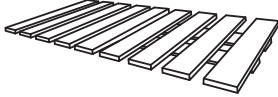

Inspect packaging to ensure all parts are accounted for before disposing of packing materials.

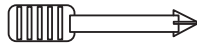
No.	PARTS		QTY.
A		Side Panel	2
B		End Panel	2
C		Bottom Panel	1
D		JCBC 60mm Bolt	8
E		Barrel Nut	8
F		Hex Key	1
G		Barrel Nut Driver	1

⚠ WARNING ⚠
CHOKING HAZARD — This item contains small parts that can be swallowed. Keep children away during assembly.

! HELPFUL HINT

This item was treated with teak oil at the factory. Apply a suitable wood oil at least once a year, or when the wood looks particularly dry. Left untreated, the wood will weather to a silvery gray color.

ASSEMBLY

NOTE: Do not fully tighten any bolt until all bolts have been placed.

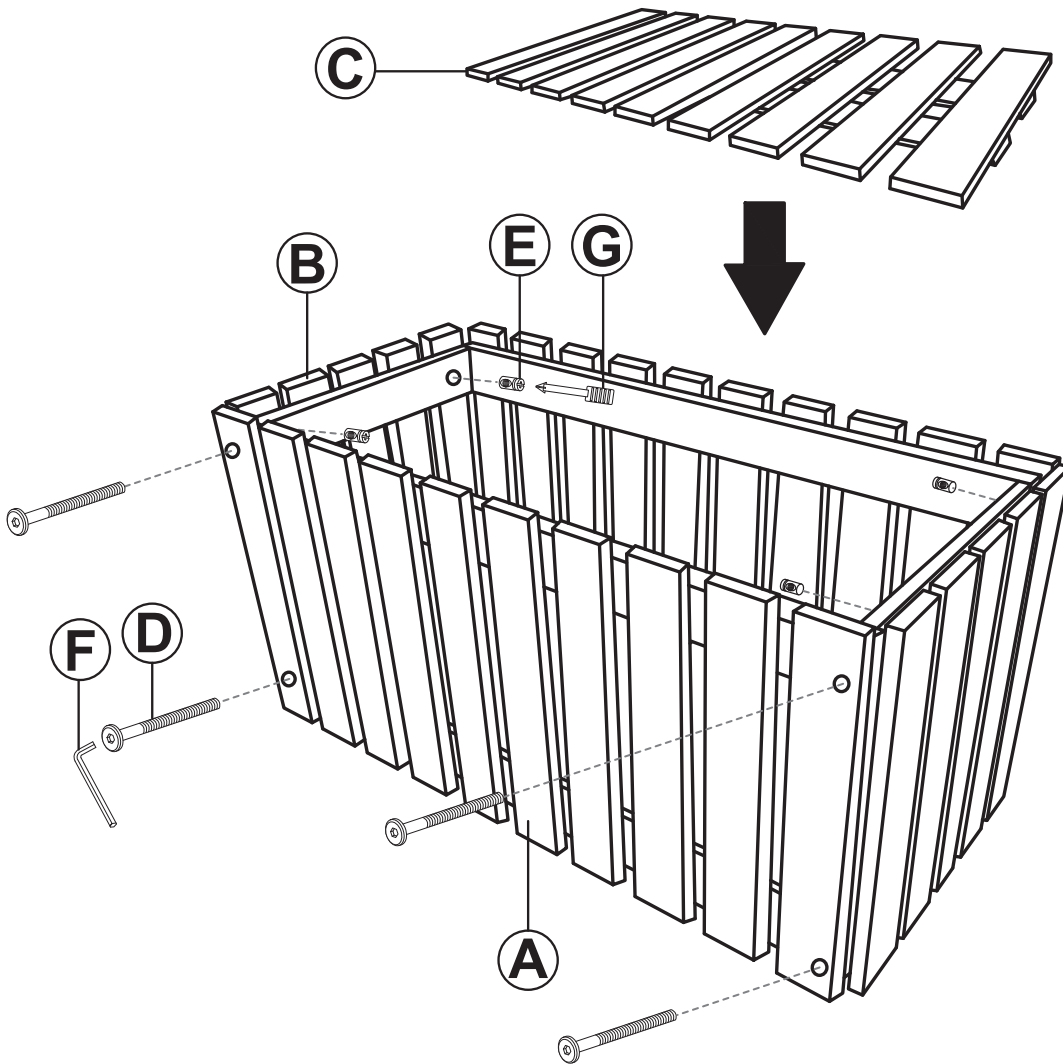

1. Lay 2x Side Panel (B) face-down on a clean, soft surface.
2. With the slotted end facing upward, place 4x Barrel Nut (E) into each side panel. Use Barrel Nut Driver (G) to turn the barrel nut so the threaded hole aligns with the pre-drilled hole.
3. Align End Panel (B) with Side Panel (C). Loosely secure by hand-tightening 2x JCBC 60mm Bolt (D).
4. Repeat step 3 until all side and end panels are loosely secured.
5. Carefully place Bottom Panel (C) into the assembled box.
6. Tighten all bolts using Hex Key (F).

USE & CARE

INSPECT: Periodically check assembly points and tighten fittings as necessary.

CLEANING: Identify the direction of the woodgrain. Following the direction of the woodgrain, wipe surfaces with a soft cloth.

MAINTENANCE: This item was treated with teak oil at the factory. Apply a suitable wood oil at least once a year, or when the wood looks particularly dry. Follow application instructions as noted with the suitable wood oil (not included).

STORAGE: Protect this item from ice and snow. Store indoors, in a dry location. Covering the unit while in storage will help prevent dust buildup.

Any modification to the product or failure to follow recommended care will void the product warranty.

⚠️ WARNING:

Manufacturer and seller expressly disclaim any and all liability from personal injury, property damage or loss, whether direct or indirect, or incidental, resulting from the incorrect attachment, improper use, inadequate maintenance, or neglect of this product.