

Truss Solid Bar Pull 3.75" Center to Center 10-Pack
Matte Black

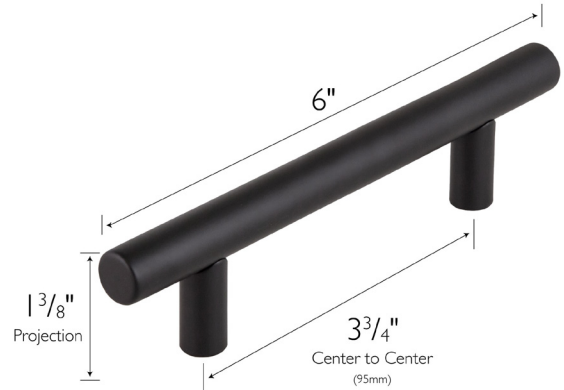

SPECIFICATIONS

MATERIAL CONSTRUCTION:	Steel
MOUNTING HARDWARE INCLUDED:	Yes
TOOLS NEEDED FOR INSTALLATION:	Screwdriver
ASSEMBLED DIMENSIONS:	1-3/8" H x 6" L
ASSEMBLED WEIGHT:	1.63 lbs
CENTER TO CENTER:	3-3/4"
PROJECTION:	1.38"

WARRANTY: 1-Year limited warranty

LEGAL FOR SALE IN CALIFORNIA: Yes



TYPE:
JOB:
ORDER CODE:
APPROVALS: