

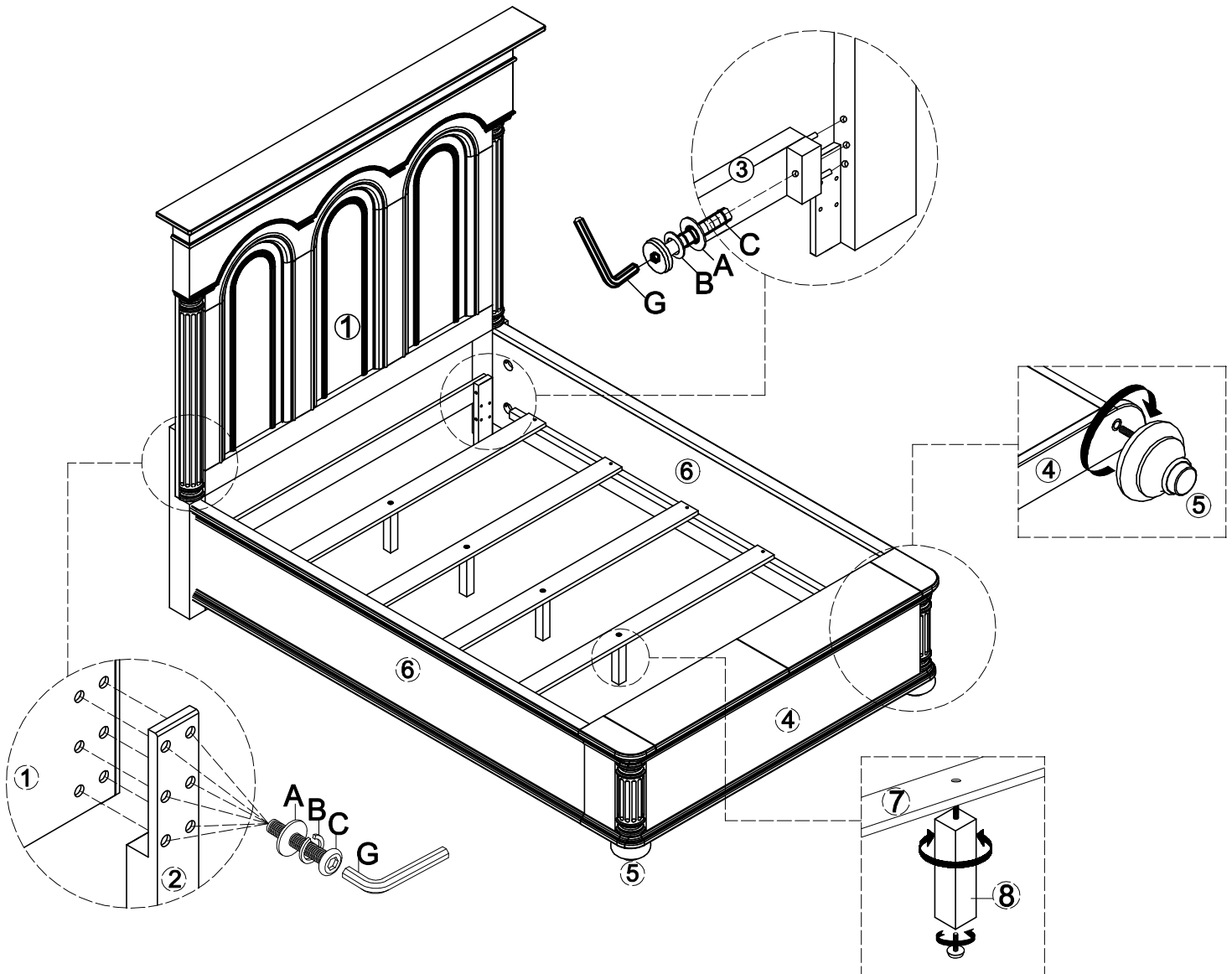

















Thank you for purchasing this quality product from A.R.T. Furniture. Be sure to check all packing material for parts which may have come loose inside the carton during shipment. Identify and count all parts and compare with the parts list below.

Note: Some furniture is heavy, it is recommended that two people assembly this item to avoid injury or damage.



No.	Hardware List		Qt.
A		Flat Washer	22
B		Lock Washer	22
C		5/16" x 1- $\frac{1}{2}$ " Bolt	14
D		Flat Washer	8
E		5/16" Nut	8
F		5/16" x 3- $\frac{1}{2}$ " Bolt	8
G		4mm Allen Wrench	1
H		Wrench	1
I		Wood Screw	10

Parts List			
1		Headboard	1
2		Headboard Legs(L&R)	2
3		Bottom Rail	1
4		Footboard	1
5		Footboard leg	2
6		Side Rail	2
7		Slats	5
8		Slat Support	5

Thank you for purchasing this quality product from A.R.T. Furniture. Be sure to check all packing material for parts which may have come loose inside the carton during shipment. Identify and count all parts and compare with the parts list below.

Note: Some furniture is heavy, it is recommended that two people assembly this item to avoid injury or damage.

