

Arm Chair

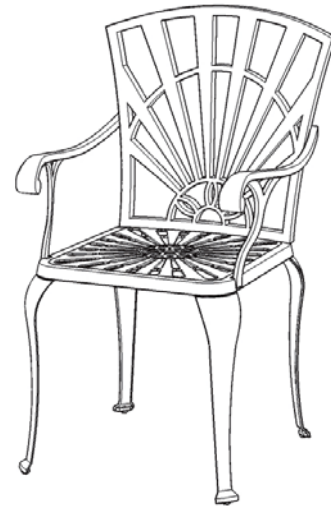

IMPORTANT

Carefully remove all the parts from the carton and place them individually on a soft cloth to prevent scratches or other damage.

Carefully and strictly follow these assembly instructions to ensure a completed product as designed.

This product is made of aluminum. Do not use power tools above 8 volts to assemble and only tighten bolts until snug. Over tightening can damage the aluminum.

Part List

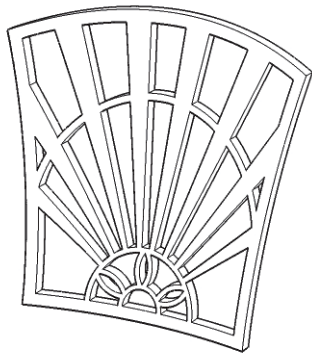

A.
Back
1 pc.

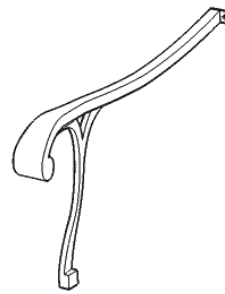

C.
Arm
1 pc.

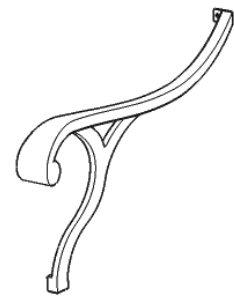

D.
Arm
1 pc.

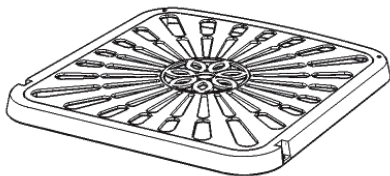

B.
Seat
1 pc.



E.
Leg
4 pcs.

Hardware List



Hex Wrench
1 pc.



Flat Washer
4 pcs. (+1 extra)



Spring Washer
4 pcs. (+1 extra)



M6x15
Head Cap Bolt (short)
4 pcs. (+1 extra)



Small Hex Wrench
1 pc.



Flat Washer (large)
10 pcs. (+1 extra)



Spring Washer (large)
10 pcs. (+1 extra)



M8x20
Head Cap Bolt
8 pcs. (+1 extra)



M8x30
Head Cap Bolt (long)
2 pcs. (+1 extra)

Tool(s) required for assembly: Level

Assembly Instructions 2/3

IMPORTANT

- Use a soft cloth between these parts and the floor.
- Do not use power tools above 8 volts to assemble.
- Do not tighten all the bolts until each part is properly assembled.
- The unit must be level to work properly. Use the included adjustable levelers to level.
- Keep Hex Wrench as the bolts may need to be tightened in the future.

STEP 1

Attach Seat (B) to Back (A) with Flat Washers (large), Spring Washers (large) and Head Cap Bolts (long), tightening bolts only halfway. (See Figure 1)

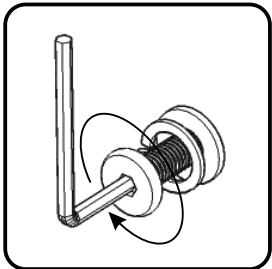
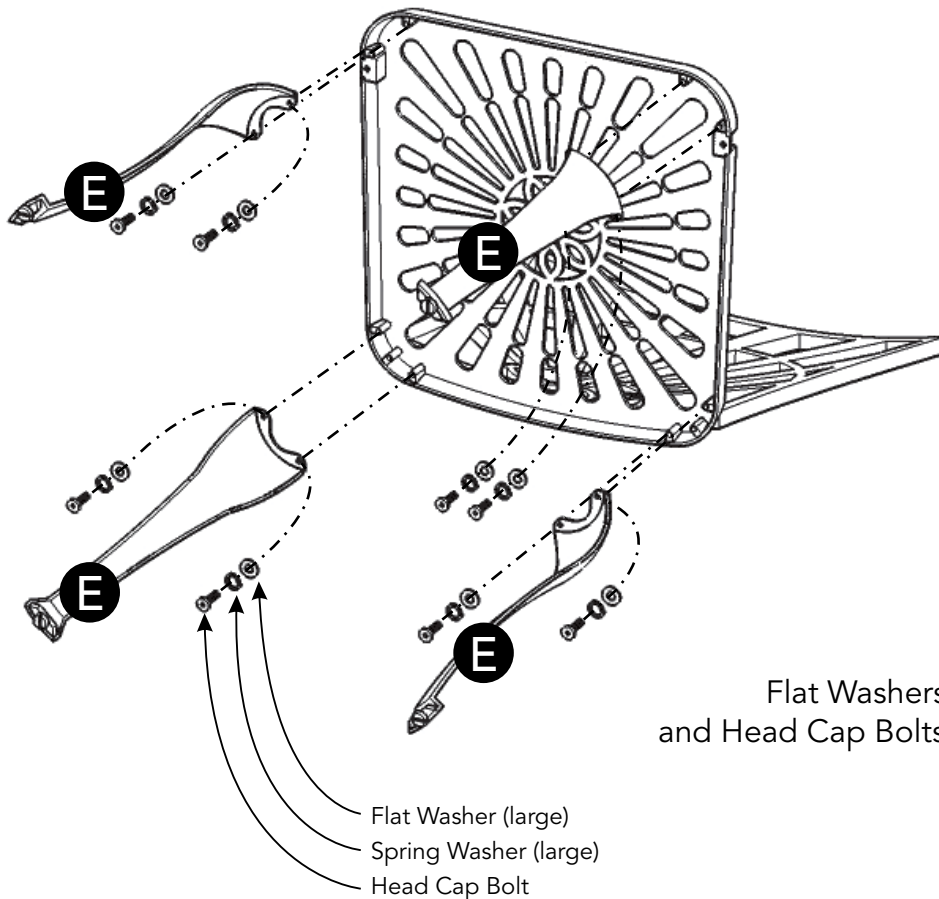
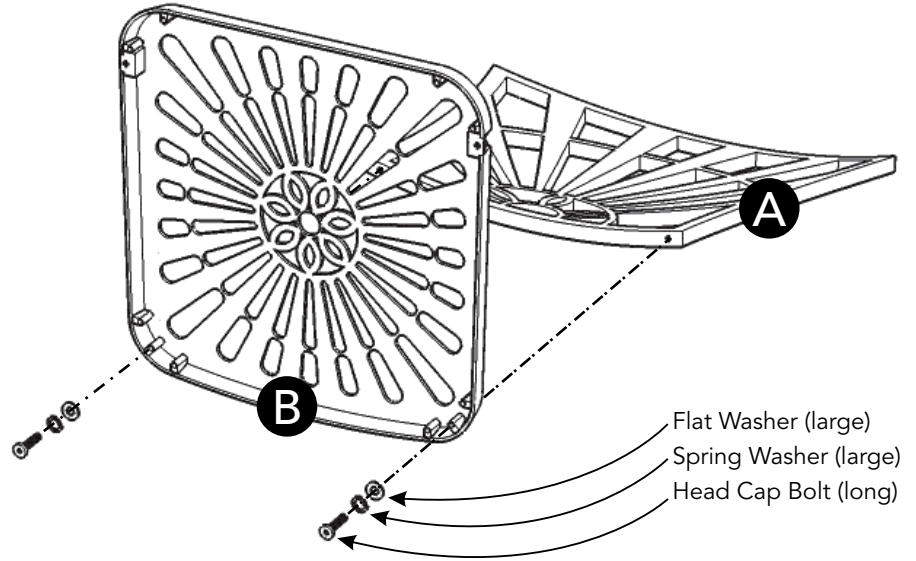

Figure 1



STEP 2

Attach Legs (E) to unit with Flat Washers (large), Spring Washers (large) and Head Cap Bolts, tightening bolts only halfway.

Assembly Instructions 3/3

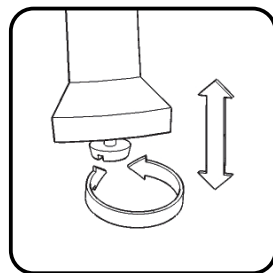
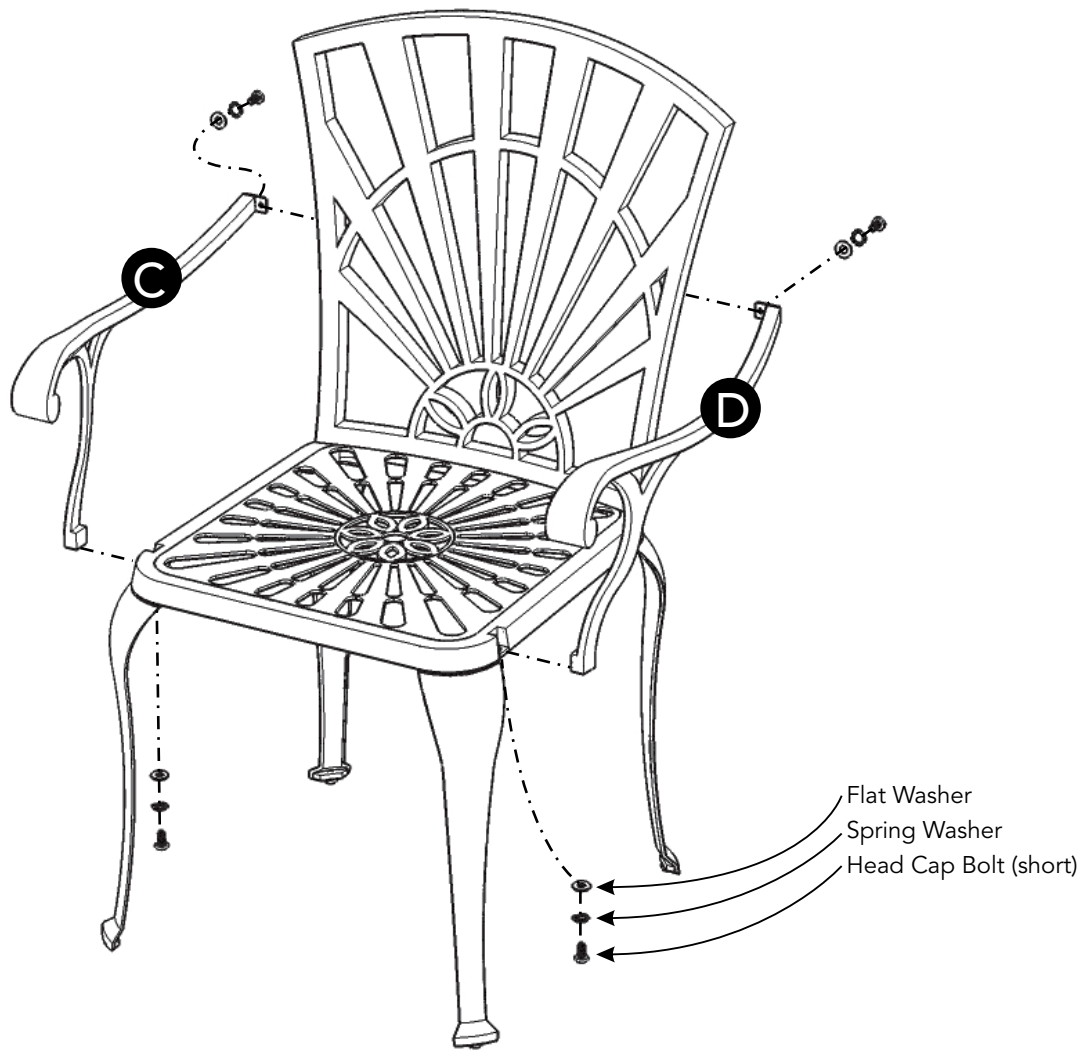

Figure 2

STEP 3

Turn unit to its upright position.

Attach Arms (C) and (D) to unit with Flat Washers, Spring Washers and Head Cap Bolts (short), tightening bolts only halfway.

Tighten all Head Cap Bolts used in Steps 1, 2 and 3.

Level unit by adjusting the adjustable levelers on bottom of legs. (See Figure 2)

CARE INSTRUCTIONS

NEVER

allow liquids to remain on furniture.
Absorption causes parts to warp
and split and finishes to delaminate.

NEVER

use glass cleaners on
finished furniture. Ammonia
chemically attacks the finish.



Do not use power tools
above 8 volts to assemble.

**PREVENT
CRACKING**



Do not place
in direct sunlight.

**PREVENT
FADING**



Do not write
directly on surface.

**PREVENT
MARKING**



Do not place hot
objects on surface.

**PREVENT
FINISH DAMAGE**



Do not use rubber
based placemats.

**PREVENT
DISCOLORING**



Do not use commercial
waxes and polishes.

**PREVENT
YELLOWING**

CLEAN

with a soft cloth moistened
in lukewarm soap and water.
Buff with a dry clean cloth.



homestyles will provide replacements free of charge for missing or damaged parts within 2 years of purchase. Digital images of the defective parts may be required. If the product was not purchased from an authorized retailer, **homestyles** is under no obligation to provide replacement parts. Parts are not available for fully assembled items nor are parts available for sale. Replacements for missing or damaged parts may be requested via contact info below.

homestyles Customer Service: www.homestylesfurniture.com,
servicedesk@homestylesfurniture.com, 888-680-7460