

Commercial Safety Grab Bar 36" Polished Chrome

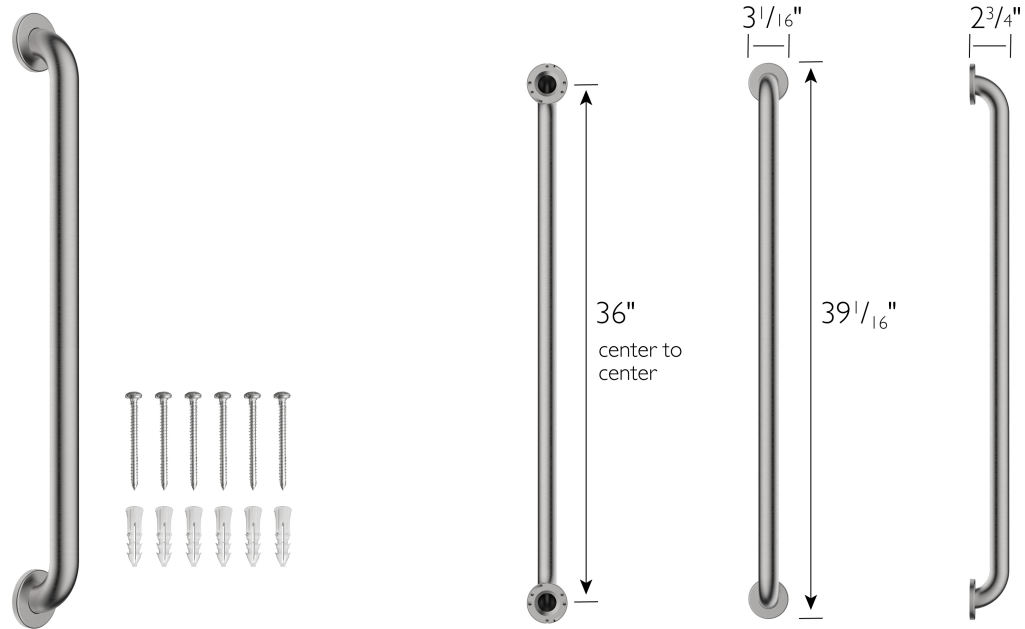

SPECIFICATIONS

MATERIAL CONSTRUCTION:	Zinc
PVD FINISH:	No
ASSEMBLY REQUIRED:	Yes
TOOLS NEEDED FOR INSTALLATION:	Screwdriver
ASSEMBLED DIMENSIONS:	3" H x 39.25" L x 3.25" D
ASSEMBLED WEIGHT:	2.6 lbs.
MIN. LENGTH:	N/A
MAX LENGTH:	N/A
SCREWS INCLUDED:	Yes
DRYWALL ANCHORS INCLUDED:	No
CENTER TO CENTER:	N/A

WARRANTY:	10-Year limited warranty
LEGAL FOR SALE IN CALIFORNIA:	Yes
ADA COMPLIANT:	N/A



TYPE:
JOB:
ORDER CODE:
APPROVALS: