

Scrubbing machine

Use and maintenance manual



by HILLYARD



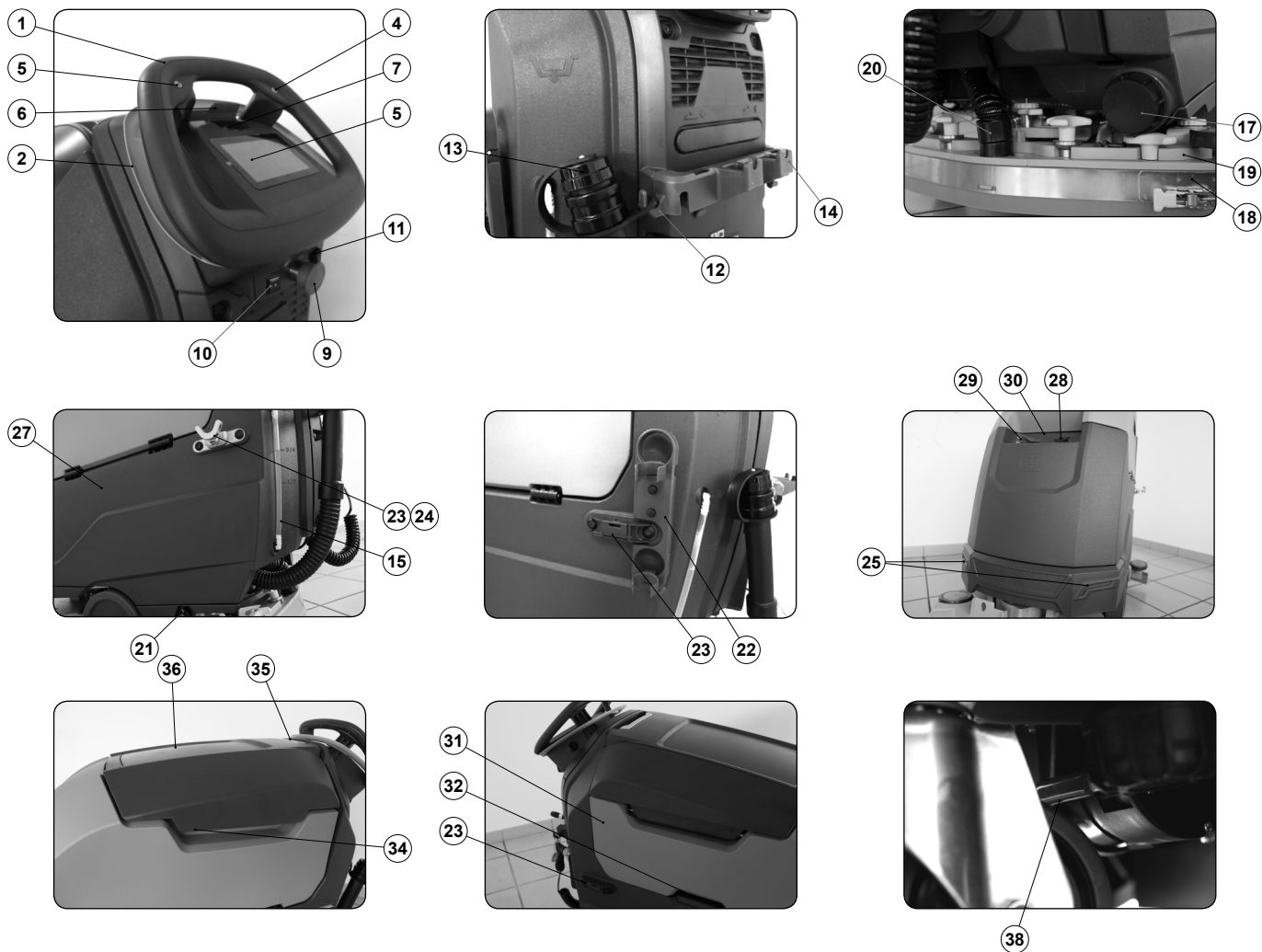

MAIN MACHINE COMPONENTS

The main machine components are the following:

1. Control handlebars.
2. Dead man's lever.
3. Reverse control button.
4. Power function control button.
5. Control display.
6. Cover for HFM ("Hillyard Fleet Management") SOS button (optional).
7. HFM ("Hillyard Fleet Management") SOS button (optional).
8. Main key switch.
9. Emergency button.
10. Spray gun control switch (optional).
11. Vacuum wand control switch (optional).
12. Support hook for recovery tank drainage tube.
13. Recovery tank drainage tube.
14. Support hook for spray gun.
15. Solution tank level indicator.
16. Built-in battery charger.
17. Solution tank drainage cap.
18. Squeegee body.
19. Squeegee body support.
20. Squeegee vacuum tube.
21. Water flow adjustment tap.
22. Vacuum accessory support.
23. Brush support.
24. Squeegee body support.
25. Headlights.
26. Brush head body.
27. Solution tank.
28. Solution tank filler cap/measuring inlet.
29. Solution tank filler tube cap.
30. Cover cap for HFF ("HILLYARD FAST FILL") quick coupling kit (optional).
31. Recovery tank.
32. Recovery tank lifting handle.
33. Machine serial number plate.
34. Recovery tank cover lifting handle.
35. Control handle for accessory compartment door.
36. Accessory compartment door.
37. Detergent solution filter.
38. Electric brake control lever.

CONTENTS

MAIN MACHINE COMPONENTS	3	<i>EMPTYING THE RECOVERY TANK</i>	22
CONTENTS	4	<i>CLEANING THE SQUEEGEE BODY</i>	22
GENERAL SAFETY REGULATIONS	5	<i>CLEANING THE BRUSH HEAD BRUSH</i>	22
<i>RECHARGING THE BATTERIES</i>	5	<i>CLEANING THE RECOVERY TANK FILTERS</i>	22
<i>USING THE MACHINE</i>	6	<i>CLEANING THE RECOVERY TANK</i>	23
<i>DEACTIVATION OF THE MACHINE</i>	8	<i>EMPTYING THE SOLUTION TANK</i>	24
<i>MAINTENANCE</i>	8	<i>CLEANING THE WATER SYSTEM FILTER</i>	24
<i>TRANSPORT</i>	9	<i>CLEANING THE VACUUM TUBE</i>	24
SYMBOLS USED IN THE MANUAL	10	<i>CLEANING THE SOLUTION TANK</i>	24
PURPOSE AND CONTENT OF THE MANUAL	10	EXTRAORDINARY MAINTENANCE WORK	24
TARGET GROUP	10	<i>REPLACING THE BRUSH HEAD BRUSH</i>	24
STORING THE USE AND MAINTENANCE MANUAL	10	<i>REPLACING THE SQUEEGEE BODY RUBBER BLADES</i>	25
ON CONSIGNMENT OF THE MACHINE	10	ADJUSTMENT INTERVENTIONS	25
INTRODUCTORY COMMENT	10	<i>ADJUSTING THE SQUEEGEE BODY RUBBER BLADES</i>	25
IDENTIFICATION DATA	10	DISPOSAL	25
TECHNICAL DESCRIPTION	10	CHOOSING AND USING THE BRUSHES	25
INTENDED USE	10	TROUBLESHOOTING	26
SAFETY	10		
CONVENTIONS	10		
SERIAL NUMBER PLATE	10		
TECHNICAL DATA	11		
SYMBOLS USED ON THE MACHINE	12		
LABELS USED ON THE MACHINE	12		
SYMBOLS ON THE CONTROL DISPLAY	12		
SYMBOLS USED ON THE SERIAL NUMBER PLATE	12		
MACHINE PREPARATION	13		
<i>HANDLING THE PACKAGED MACHINE</i>	13		
<i>HOW TO UNPACK THE MACHINE</i>	13		
<i>HOW TO MOVE THE MACHINE</i>	13		
<i>MACHINE SAFETY MEASURES</i>	14		
<i>TYPE OF BATTERY TO BE USED</i>	14		
<i>BATTERY MAINTENANCE AND DISPOSAL</i>	14		
<i>INSERTING THE BATTERIES IN THE MACHINE</i>	14		
<i>CONNECTING THE BATTERIES TO THE MACHINE SYSTEM</i>	14		
<i>RECHARGING THE BATTERIES</i>	14		
<i>ASSEMBLING THE BRUSH</i>	15		
<i>ASSEMBLING THE SQUEEGEE BODY</i>	15		
<i>FILLING THE SOLUTION TANK WITH WATER</i>	15		
<i>DETERGENT SOLUTION (VERSIONS WITHOUT HDC)</i>	15		
<i>FILLING THE DETERGENT CANISTER (VERSIONS WITH HDC)</i>	15		
PREPARING TO WORK	16		
WORK	16		
<i>TRANSFER</i>	17		
<i>SCRUBBING WITHOUT DRYING</i>	17		
<i>DRYING</i>	18		
<i>SCRUBBING WITH DRYING</i>	18		
<i>DS SELECTOR (DRIVE SELECT)</i>	19		
<i>ECO MODE</i>	19		
<i>MANUAL MODE</i>	19		
<i>ZONE PROGRAM BUTTON</i>	19		
<i>REVERSE</i>	19		
<i>EXTRA BRUSH HEAD PRESSURE</i>	20		
<i>HILLYARD DOSING CONTROL (HDC) SYSTEM</i>	20		
<i>TUTORIAL</i>	20		
<i>EMERGENCY SWITCH</i>	20		
<i>HOUR METER</i>	20		
<i>BATTERY CHARGE LEVEL INDICATOR</i>	20		
<i>VACUUM WAND KIT</i>	21		
<i>SMART DRYING SYSTEM</i>	21		
<i>SOLUTION TANK OVERFLOW</i>	21		
<i>ALARM SCREEN</i>	21		
AT THE END OF THE WORK	21		
RECOMMENDED MAINTENANCE OPERATIONS	22		

GENERAL SAFETY REGULATIONS

The following symbols are used to indicate any potentially hazardous situations. Always read this information carefully and take the necessary precautions to protect any people and/or objects that may be present.

Operator cooperation is paramount for accident prevention. No accident prevention programme can be effective without the full cooperation of the person directly responsible for operating the machine. The majority of occupational accidents that happen either in the workplace or whilst moving are caused by failure to respect the most basic safety rules. An attentive, careful operator is most effective guarantee against accidents and is fundamental in order to implement any prevention programme.



DANGER: Indicates an imminent danger that could cause serious injury or death.



WARNING: Indicates a probable dangerous situation that could cause serious injury or death.



CAUTION: Indicates a probable dangerous situation that could cause minor injuries.



ATTENTION: Indicates a probable dangerous situation that could damage objects.

RECHARGING THE BATTERIES



DANGER:

- If the battery charger power cable is damaged or broken, it should be replaced by the manufacturer or authorised service personnel, or another qualified person, in order to protect against hazards.
- The socket for the battery charger cable must have a prescribed earth connection.
- Keep sparks, flames, and incandescent materials at a safe distance from the batteries. Explosive gases are emitted during normal use.
- Highly explosive hydrogen gas is generated while charging the batteries. Keep the recovery tank unit in the maintenance position during the entire battery recharging cycle, and only perform the procedure in well-ventilated areas at a safe distance from any open flames.
- Before charging, make sure the electric cable that connects the battery charger to the batteries is not damaged. If it is, don't use it; contact technical assistance.
- Before starting to charge the batteries, check there is no stagnant water or humidity in the on-board battery charger socket.
- Before charging, make sure the electric cable that connects the battery charger to the mains is not damaged. If it is, don't use it; contact technical assistance.
- Do not disconnect the DC cable of the battery charger from the machine socket while the battery charger is operating. This is necessary in order to avoid electric arcs forming. To disconnect the battery charger when it is charging, first disconnect the AC power cable.



WARNING:

- Do not use an incompatible battery charger as it could damage the batteries and potentially cause a fire.
- The batteries emit hydrogen gas. This gas can cause explosions or fires. Keep a safe distance from flames or sparks. Keep the covers open when charging the batteries.
- Before using the battery charger, make sure the frequency and voltage values indicated on the machine data plate coincide with the network values.
- Keep the battery charger cable at a safe distance from any hot surfaces.
- Never smoke in the vicinity of the machine while the batteries are charging.

- Before starting the charging operation, carefully read the user manual of the battery charger that you want to use.

USING THE MACHINE



DANGER:

- In the event of danger, take prompt action by pressing the emergency button on the back of the machine (near the control handlebars).
- Never collect gases, explosive/inflammable liquids or powders, nor acids and solvents! These include gasoline, paint thinners and fuel oil (which, when mixed with the vacuum air, can form explosive vapours or mixtures), and also non-diluted acids and solvents, acetones, aluminium and magnesium powders. These substances may also corrode the materials used to construct the machine.
- If the machine is used in dangerous areas (e.g. petrol stations), the relative safety standards must be observed. It is forbidden to use the machine in environments with a potentially explosive atmosphere.



WARNING:

- **The machine may be used by children over the age of 8 and by people with limited physical, sensorial or mental capacity, or people without experience or the required knowledge, as long as they are supervised or have been instructed about safe machine use and the inherent dangers. Children must not play with the machine. The cleaning and maintenance that should be carried out by the user should not be done by unsupervised children.**
- The machine must only be used by authorised, trained personnel.
- Do not use the machine on surfaces with a slope greater than the one indicated on the serial number plate.
- The machine is not suitable for cleaning rough or uneven floors. Do not use the machine on slopes.
- In the event of a fire, use a powder extinguisher. Do not use water.
- Adapt the speed to the adhesion conditions.
- Do not use the machine if you do not have the requisite knowledge or authorisation.
- Do not use the machine if you have not read and understood the following user manual.
- Do not use the machine under the influence of alcohol or drugs.
- Do not use the machine while using a mobile phone or other electronic devices.
- Do not use the machine if it is not working correctly.
- Do not use the machine in areas where there are inflammable vapours or liquids or combustible powders.
- Do not use the machine in areas where it is too dark to see the controls or operate the machine safely, unless the work lights or the front headlights are on.
- To prevent the unauthorised use of the machine, the power supply must be disconnected: switch the machine off using the main switch (by removing the key from the block) and disconnect the battery connector from the electrical system connector.



CAUTION:

- Children must be supervised to ensure they do not play with the machine.
- During machine operation, pay attention to other people and especially to children.

- The machine must only be powered with a voltage equal to that shown on the serial number plate.
- Read the labels on the machine carefully. Do not cover them for any reason, and replace them immediately if they become damaged.
- The machine must only be used and stored in an enclosed or covered environment.
- The machine must not be used or stored outdoors in damp conditions or directly exposed to rain.
- The machine does not cause harmful vibrations.
- Use the machine only in the way described in this manual.
- Do not pick up anything that is burning or smouldering, like cigarettes, matches or glowing embers.
- Reduce speed on slopes and dangerous corners.
- Reduce speed before making a turn.
- Always follow the instructions for mixing, use and disposal on the containers of the chemical substances.



ATTENTION:

- Always take appropriate measures to protect any individuals and/or objects that may be present while using this machine.
- Be careful to avoid collisions with shelving or scaffolding, above all if there is a risk of objects falling from heights.
- Do not place any liquid containers on the machine.
- The machine must only be used in temperature conditions ranging from 32°F to +104°F.
- When using detergents to clean the flooring, always follow the instructions and respect the warnings indicated on the container labels.
- Always use appropriate gloves and protective equipment when handling the detergents used to clean the floor.
- Avoid working with the brushes when the machine is standing still, so as not to damage the floor.
- In the event of a fire, use a powder fire extinguisher if possible, and avoid the use of water.
- Do not allow any objects to penetrate into the machine openings. Do not use the machine if the openings are obstructed.
- Keep the machine openings free of dust, lint, hairs, or any other foreign materials that could reduce the airflow.
- Do not remove or alter any labels fixed to the machine.
- Only use the brushes and pad holders that have been supplied with the machine, or those specified in the Use and Maintenance Manual. The use of other brushes or felt pads may compromise the machine safety conditions.
- Before starting to work, check there are no leaks.
- Before starting to work, check that all the safety devices have been installed and are working correctly.

DEACTIVATION OF THE MACHINE



WARNING:

- Always protect the machine against sunlight, rain, and other atmospheric agents, both while it is stationary and while it is functioning. Store the machine in a dry, sheltered place: this machine is only designed for use under dry conditions, and must not be used or stored outdoors in humid conditions.
- Do not park the machine near combustible materials, powders, gases or liquids.
- Stop the machine on a flat surface.
- Make sure the electric brake is engaged, then switch off the machine via the main switch (removing the key from the block) and disconnect the battery connector from the electrical system connector.
- If the machine is left unattended, it must be protected from any accidental movements



ATTENTION:

- The machine must only be stored in temperature conditions ranging from 32°F to +104°F. The humidity level must be between 30% and 95%.

MAINTENANCE



DANGER:

- To avoid short-circuits when working in the vicinity of electrical components: avoid the use of non-insulated tools; do not place or allow metallic objects to fall on the electrically powered components; remove rings, watches and/or clothing with metallic parts that might come into contact with the electrically powered components.
- Do not work underneath the raised machine without adequate fixed safety supports.



WARNING:

- Read all the relevant instructions carefully before performing any maintenance/repair operations.
- If the machine does not work properly, check this is not caused by failure to carry out routine maintenance. Otherwise, ask for the intervention of the authorised technical assistance centre.
- Restore all electrical connections after any maintenance interventions.



CAUTION:

- When doing maintenance work, switch off the machine using the main switch. Remove the key from the block and disconnect the battery connector from the electrical system connector.
- Avoid contact with moving parts. Do not wear loose clothing or jewellery, and tie long hair back.
- Block the wheels before lifting the machine.
- Lift the machine with equipment that can sustain the weight to be lifted.



ATTENTION:

- Never tamper with the machine protection devices for any reason. Always follow the supplied routine maintenance instructions scrupulously.

- If the machine needs to be pushed for maintenance purposes (batteries absent; discharged batteries; etc.), never exceed 2.49 mph.
- If there are any machine operation anomalies, check they are not due to a lack of proper maintenance. Otherwise, request the intervention of authorised personnel or an authorised service centre.
- If any parts need to be replaced, always request ORIGINAL spare parts from an authorised dealer or retailer.
- To ensure machine safety and its proper functioning, always have the scheduled maintenance interventions (specified in the appropriate section of this manual) performed by authorised personnel or by an authorised service centre.
- Do not clean the machine with direct or pressurised jets of water, or with corrosive substances.
- If lead batteries (WET) have been installed on the machine, avoid tilting it beyond 30° in relation to the horizontal plane, as this could cause the highly corrosive liquid to leak out of the batteries.
- Avoid contact with the battery acid.
- Keep all metal objects away from the batteries.
- Use a non-conductive device to remove the battery.
- Use a hoist and suitable equipment when lifting the batteries.
- The battery must be installed by qualified personnel.
- Always observe the safety measures of the site regarding battery removal.
- If the machine needs to be tilted for maintenance procedures, remove the batteries.
- Have the machine checked by an authorised technical assistance centre every year.
- When disposing of consumable materials, observe the laws and regulations in force. Once the machine has reached the end of its service life, the materials contained within it must be disposed of in an appropriate manner, keeping in mind that the machine itself has been built using fully recyclable materials.
- Only push or tow the machine when the seat is occupied by an operator able to control the machine.
- Do not wash the machine with pressurised water, or wet it in the vicinity of electrical components.
- All repairs must be carried out by qualified personnel.
- Do not physically change the design characteristics of the machine.
- Use spare parts provided by authorised service centres.
- Wear personal protective equipment as required and as suggested in the manual.

TRANSPORT

WARNING:

- Drain both tanks before transport.
- Bring both the squeegee and the brushes to a working position before securing the machine to the transport vehicle.
- Use a ramp, truck or trailer that can support the weight of the machine and the operator.
- The ramp gradient must not be such as to cause damage to the machine as it moves up onto the vehicle.
- Make sure the electric brake is correctly engaged after loading the machine onto the transport vehicle.

The descriptions contained in this document are not binding. The company therefore reserves the right to make any modifications at any time to elements, details, or accessory supply, as considered necessary for reasons of improvement or manufacturing/commercial requirements. The reproduction, even partial, of the text and drawings contained in this document is prohibited by law.

The company reserves the right to make any technical and/or supply modifications. The images are shown as reference only and are not binding as to the actual design and/or equipment.

SYMBOLS USED IN THE MANUAL



Symbol of the open book with i:
Indicates the need to consult the instruction manual.



Symbol of the open book:
Tells the operator to read the user manual before using the device.



Covered place symbol:
The operations preceded by this symbol must always be carried out in a dry, covered area.



Information symbol:
Indicates additional information for the operator, to improve the use of the device.



Warning symbol:
Carefully read the sections preceded by this symbol meticulously following the instructions indicated for the safety of the operator and the device.



Danger symbol (corrosive substances):
The operator should always wear protective gloves to avoid the risk of serious injury to the hands caused by corrosive substances.



Danger symbol (battery acid leakage):
Indicates the danger of leaking acid or acid fumes from the batteries while they are being recharged.



Danger symbol (moving carriages):
Indicates that the packed product should be handled with suitable carriages that conform to legal requirements.



Mandatory room ventilation symbol:
Informs the operator that the room must be ventilated while the batteries are being recharged.



Symbol indicating the compulsory use of protective gloves:
Indicates that the operator should always wear protective gloves, to avoid the risk of serious injury to his hands from sharp objects.



Symbol indicating a treading ban:
Informs the operator that it is forbidden to tread on machine components, as this could lead to serious injury.



Recycling symbol:
Tells the operator to carry out the operations in compliance with environmental regulations in force in the place where the appliance is being used.



Disposal symbol:
Carefully read the sections marked with this symbol for disposing of the appliance.

PURPOSE AND CONTENT OF THE MANUAL

The aim of this manual is to provide customers with all the information needed to use the machine in the safest, most appropriate and most autonomous way. This includes information concerning technical aspects, safety, operation, downtime, maintenance, spare parts and scrapping. The operators and qualified technicians must carefully read the instructions in this manual before carrying out any operations on the machine. If in doubt about the correct interpretation of instructions, contact your nearest Customer Service Centre to obtain the necessary clarifications.

TARGET GROUP

This manual is written both for operators and for qualified machine maintenance technicians. Operators must not perform operations that should be carried out by qualified technicians. The manufacturer is not liable for damages resulting from failure to comply with this veto.

STORING THE USE AND MAINTENANCE MANUAL

The Use and Maintenance Manual must be stored in its special pouch close to the machine, protected from liquids and anything else that could compromise its legibility.

ON CONSIGNMENT OF THE MACHINE

When the machine is consigned to the customer, an immediate check must be performed to ensure all the material mentioned in the shipping documents has been received, and also to check the machine has not suffered damage during transportation. If this is the case, the carrier must ascertain the extent of the damage at once, informing our customer service office. It is only by prompt action of this type that the missing material can be obtained, and compensation for damage successfully claimed.

INTRODUCTORY COMMENT

Any floor scrubbing machine can only work properly and effectively if used correctly and kept in full working order by performing the maintenance operations described in the attached documentation. We therefore suggest you read this instruction booklet carefully and read it again whenever difficulties arise while using the machine. If necessary, remember that our assistance service (organised in collaboration with our dealers) is always available for advice or direct intervention.

IDENTIFICATION DATA

For technical assistance or to request replacement parts, always give the model, the version and the serial number (written on the relevant plate).

TECHNICAL DESCRIPTION

The **TRIDENT T20SC PRO** is a floor scrubbing machine that can work on various types of floor and dirt thanks to the mechanical action of a brush and the chemical action of a water-detergent solution. As it advances, it collects the dirt removed, along with the detergent solution not absorbed by the flooring itself. **The machine must only be used for this purpose.**

INTENDED USE

This scrubbing machine was designed and built for the cleaning (scrubbing and drying) of smooth, compact flooring in the commercial, residential and industrial sectors by a qualified operator in proven safety conditions. The scrubbing machine is not suitable for cleaning rugs or carpet floors. It is only suitable for use in closed (or at least covered) places.

 **ATTENTION:** the machine is not suitable for use in the rain, or under water jets.

 **IT IS FORBIDDEN** to use the machine for picking up dangerous dusts or inflammable liquids in places with an explosive atmosphere. In addition, it is not suitable as a means of transport for people or objects.

SAFETY

Operator cooperation is paramount for accident prevention. No accident prevention programme can be effective without the full cooperation of the person directly responsible for machine operation. The majority of occupational accidents that happen either in the workplace or whilst moving are caused by failure to respect the most basic safety rules. An attentive, careful operator is most effective guarantee against accidents and is fundamental in order to implement any prevention programme.

CONVENTIONS

All references to forwards and backwards, front and rear, right and left indicated in this manual should be understood as referring to the operator in the driving position, with his/her hands on the control handlebars (1).

SERIAL NUMBER PLATE

The serial number plate (78) is located above the electric system panel, inside the machine. It shows the general machine characteristics, in particular the serial number. The serial number is a very important piece of information and should always be provided together with any request for assistance or to purchase spare parts.



TECHNICAL DATA

TECHNICAL DATA	US cu	TRIDENT RS26 SC
Rated machine power	W	1410
Working capacity up to	ft ² /h	34552
Working width	in	25,8
Squeegee width	in	30,8
Brush head brush diameter	in	13,4
Number of brush head brush rotations	rpm	240
Brush head gearmotor (voltage / nominal power)	V - W	24 - 400
Down pressure on the brush head	lb	up to 110
Maximum possible gradient for uphill and downhill movement (weight ⁽²⁾)	%	10
Maximum slope during ascent and descent with the transport program (weight ⁽²⁾)	%	10
Maximum ambient temperature for machine operation	°F	104
Minimum ambient temperature for using the machine's scrubbing functions	°F	32
Traction motor (voltage / rated power)	V - W	24 - 180
Traction wheel (external Ø / width)	in	8,9 x 2,6
Maximum forward speed in transport mode	mph	3

TECHNICAL DATA	US cu	TRIDENT RS26 SC
Vacuum motor (voltage - nominal power rating)	V - W	24 - 422
Vacuum on vacuum head	psi	1,75
Maximum solution tank capacity	gal	13,9
Maximum recovery tank capacity	gal	14,3
Turning circle	in	-
Machine dimensions (length - width - height)	in	51,7 - 27,4 - 43,2
Battery compartment dimensions (width - length - useful height)	in	13,8 - 7 - 11
Recommended battery	n° - V - AhC5	2 - 12 - 112
Machine weight ⁽¹⁾	lb	-
Machine weight during transport ⁽²⁾	lb	-
Machine weight during work operations ⁽³⁾	lb	-
Maximum battery weight (recommended)	lb	86
Sound pressure level (ISO 11201) - L _{PA}	dB (A)	<70
Uncertainty K _{PA}	dB (A)	1,5
Hand vibration level (ISO 5349)	m/s ²	<2,5
Vibration measurement uncertainty		-

- Remarks:
- (1) Machine weight: refers to the overall machine weight without the batteries, and with both tanks empty.
 - (2) Machine weight during transport: refers to the overall machine weight with the batteries, but with both tanks empty.
 - (3) Machine weight during work operations: refers to the overall machine weight with the batteries, with the solution tank full and the detergent canister full (valid for HDC versions), but with the recovery tank empty.

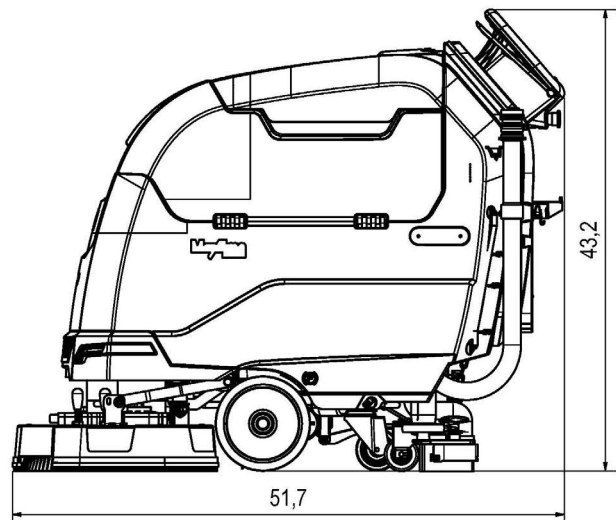
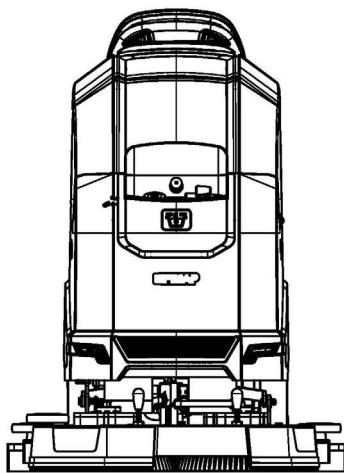
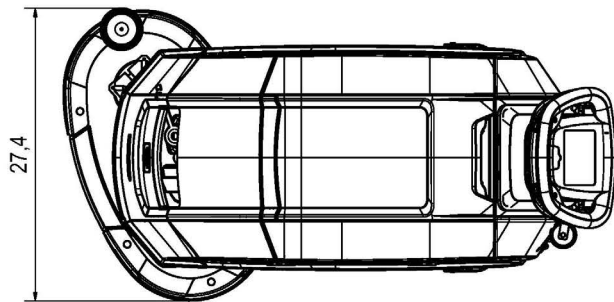
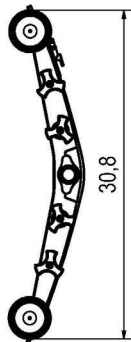
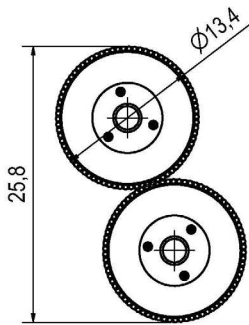

SYMBOLS USED ON THE MACHINE



Symbol of maximum temperature for filling the solution tank:
Located on the front of the solution tank, to indicate the maximum temperature of the water for filling the solution tank safely.



Filter body position symbol:
Located on the right-hand side of the machine to indicate the position of the detergent solution filter.



Position symbol for the solution tank drainage cap:
Applied to the back of the machine to identify the solution tank drainage cap.



Position symbol for the recovery tank drainage tube:
Applied to the back of the machine to identify the recovery tank drainage tube.



Battery connection symbol:
Located on the front of the solution tank, to indicate how to connect the 12V batteries in order to obtain a total voltage of 24V.

LABELS USED ON THE MACHINE



Label for detergent solution tap control:
Located on the right-hand side of the machine, to identify the control knob of the detergent solution tap.



Label indicating the need to read the Use and Maintenance Manual:
Attached to the machine in order to warn the operator to read the user and maintenance manual (this document) before using the machine for the first time.



Battery recharge warning label:
Located inside the machine (above the electric system carter), to warn the operator when it's necessary to recharge the batteries.



Daily care warning label:
Applied to the machine to remind the operator of the necessary procedures to properly care for the machine itself.



Machine use warning label:
Located on the rear of the machine, to warn the operator which substances cannot be removed with the machine.



Solution tank filter daily care warning label:
Applied to the machine to remind the operator to clean the solution tank after each use.



Moving brush hazard label:
Used on the machine to warn the operator not to place his/her hands near the moving brush.



Label warning about the risk of crushed hands:
Indicates danger to hands due to crushing between two surfaces.

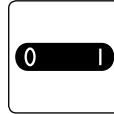

Main switch symbol:
Located near the control panel, to indicate the main key switch.

SYMBOLS ON THE CONTROL DISPLAY



1. HFM symbol, if visible it shows that the "HILLYARD FLEET MANAGEMENT" system is active.
2. HDC symbol, if visible it shows that the "HILLYARD DOSING CONTROL" system is active.
3. Hour meter.
4. Battery charge level percentage.
5. General alarm symbol.
6. Solution tank float symbol. If visible, it shows that the recovery tank is empty and that to continue you need to fill it.
7. Detergent solution level symbol.
8. Vacuum motor performance level symbol.
9. HILLYARD ECO MODE program button.
10. Drive Select selector.
11. Brush uncoupling button (single-brush version).
12. Menu screen activation button.
13. Text indicator.
14. Zone program selector button.
15. Brush head extra pressure level symbol.
16. Forward speed level symbol.

SYMBOLS USED ON THE SERIAL NUMBER PLATE

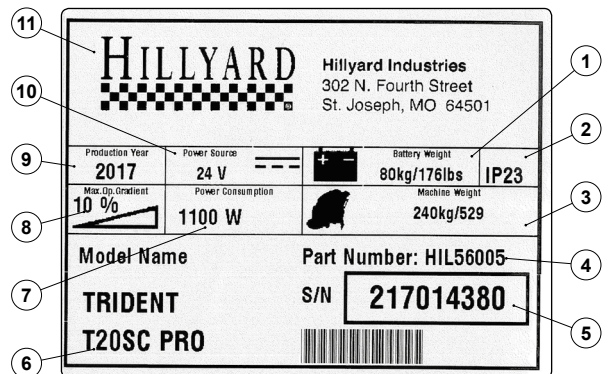

The serial number plate shows the following information:

1. The weight of the batteries that power the machine (expressed in kg).
2. The IP protection rating of the machine.
3. The gross weight of the machine (expressed in kg).
4. The machine ID code.
5. The machine serial number.
6. The machine ID name.
7. The nominal power consumed by the machine (expressed in W).
8. The maximum grade that the appliance can handle during work activities (expressed in %).
9. The year of machine manufacture.
10. The nominal voltage of the machine (expressed in V).
11. The commercial name of the machine, and the manufacturer's address.

MACHINE PREPARATION

HANDLING THE PACKAGED MACHINE

The machine is contained in specific packaging, and since the packaging elements (plastic bags, staples, etc.) are a potential source of danger, they should not be left within the reach of children, disabled persons, etc.

The overall machine weight including packaging is 000 lb.
The overall dimensions of the package are: A=30in B=57.5in C=50in.

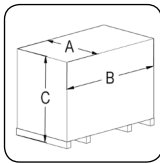

ATTENTION: it is recommended that all the packaging components be kept for any future transportation of the appliance.

ATTENTION: move the packaged product with handling equipment that complies with legal requirements regarding size and mass of the packaging.

HOW TO UNPACK THE MACHINE

The machine is shipped in specific packaging. To remove it, proceed as follows:

1. Place the lower part of the outer packaging in contact with the floor.

NB: use the pictograms printed on the box as a reference.

2. Remove the outer package.

WARNING: the machine is contained in specific packaging materials, whose elements (plastic bags, staples, etc.) can pose potential hazards, and must not be left within reach of children, disabled persons, etc.

3. Remove the boxes containing the disc brushes and squeegee body from the machine.

CAUTION: these operations must be carried out using protective gloves to avoid any possible contact with the edges or tips of metal objects.

4. Insert a ramp in the rear part of the machine.

ATTENTION: the ramp gradient must not be such as to cause damage to the machine as it comes down.

5. The machine is fixed to the pallet with wedges (1) that block the wheels (Fig.1). Remove these wedges.

6. Check the main switch on the control panel is set to "0". If this is not the case, turn the key (2) to the left (Fig.2). Remove the key from the main switch.

7. Grip the handle (3) and raise the recovery tank to the maintenance position (Fig.3).

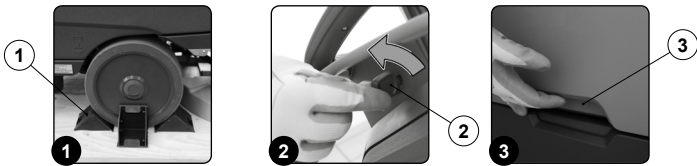

8. Connect the backup battery carriage connector to the main machine system connector (Fig.4).

9. Grip the handle (3) and lower the recovery tank to its working position (Fig.5).

10. Insert the key (1) in the main switch on the control panel. Set the main switch to "I" by making a quarter turn of the key to the right (Fig.6).



11. A few seconds after ignition, the password screen is displayed (Fig.7).

12. Enter the password and press the Enter key (4) (Fig.7).

NB: if you make a mistake, press Delete (5) (Fig.7).

NB: it is possible to disable the password entry. Contact your nearest assistance centre.

NB: the password entered by the manufacturer is 0000.

13. By default, the machine is set to the transfer program (6) (Fig.8).

NB: in transfer mode, both the brush head and the squeegee support are in the idle position (raised from the pallet).

NB: on the DS selector, the symbol of the transport program (6) is green (Fig.8).

NB: the grey symbols show working programs that are not active. the green symbols show working programs that are active.

14. Press the "REVERSE ACTIVATION - DEACTIVATION" button (7) (Fig.9) to engage the reverse gear.

15. When you push the dead man's lever (8) (Fig.10), the machine will begin to move.

16. Drive the machine down the ramp.

ATTENTION: during this operation, check there are no people or objects near the machine.

17. Set the main switch to "0", turning the key (1) to the left (Fig.2). Remove the key from the main switch.
18. Grip the handle (2) and raise the recovery tank to the maintenance position (Fig.3).
19. Disconnect the backup battery carriage connector from the main machine system connector (Fig.4).
20. Grip the handle (4) and lower the recovery tank to its working position (Fig.5).

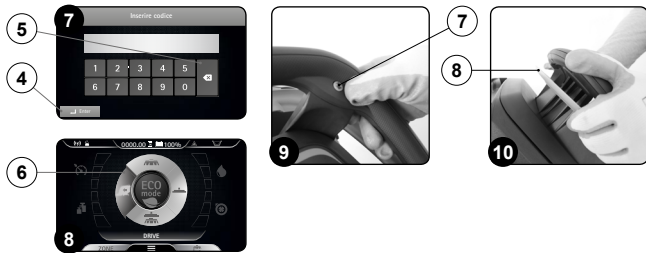

HOW TO MOVE THE MACHINE

To transport the machine safely, proceed as follows:

DANGER: before starting any task, make sure the current regulations concerning the safe transport of dangerous substances are scrupulously observed.

1. Check the solution tank and recovery tank are empty. If they aren't, empty them (see "EMPTYING THE SOLUTION TANK" and "EMPTYING THE RECOVERY TANK").
2. Insert the key (1) in the main switch on the control panel. Set the main switch to "I" by turning the key (1) to the right (Fig.1).
3. Using the DS selector on the control display (Fig.2), select the "transfer" program (2).

NB: with this working program, both the brush head and the squeegee support are in the idle position (raised from the floor).

NB: on the DS selector, the symbol of the transport program (2) is green (Fig.2).

NB: the grey symbols show working programs that are not active. the green symbols show working programs that are active.

4. When you push the dead man's lever (3) (Fig.3), the machine will begin to move.
5. Use a ramp to move the machine up onto the transport vehicle.



CAUTION: during this operation, check there are no people or objects near the machine.

NB: the ramp gradient must not be such as to cause damage to the machine as it goes up.

6. Once the machine is on the means of transport, set the main switch to "0" by turning the key (1) to the left (Fig.4). Remove the key from the main switch.
7. Get off the machine.
8. Grip the handle (4) and raise the recovery tank to the maintenance position (Fig.5).
9. Disconnect the battery connector from the main machine system connector (Fig.6).
10. Grip the handle (4) and lower the recovery tank to its working position (Fig.7).

WARNING: secure the device according to the directives in force in the country of use, so that it cannot slide or tip over.

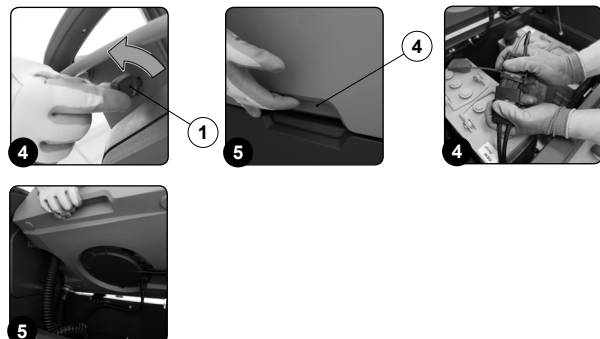

MACHINE SAFETY MEASURES

To ensure that work is carried out in the best safety conditions, proceed as follows:

1. Make sure the solution tank is empty. If it isn't, empty it (see "[EMPTYING THE SOLUTION TANK](#)").
 2. Make sure the recovery tank is empty. If it isn't, empty it (see "[EMPTYING THE RECOVERY TANK](#)").
 3. Using the DS selector on the control display (Fig.1), select the "transfer" program" (1).
- (i) NB:** with this working program, both the brush head and the squeegee support are in the idle position (raised from the floor).
- (i) NB:** on the DS selector, the symbol of the transport program (1) is green (Fig.1).
- (i) NB:** the grey symbols show working programs that are not active. the green symbols show working programs that are active.
4. Set the main switch to "0" position by turning the key (2) to the left (Fig.2). Remove the key from the instrument panel.
 5. Grip the handle (3) and raise the recovery tank to the maintenance position (Fig.3).

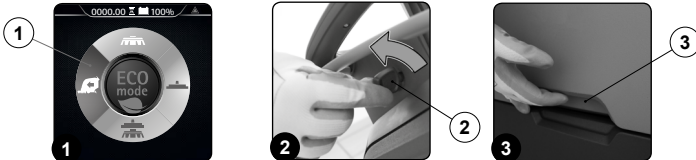

6. Disconnect the battery connector from the main machine system connector (Fig.4).
7. Grip the handle (3) and rotate the recovery tank to its working position (Fig.5).



TYPE OF BATTERY TO BE USED

Power to the machine must be supplied by two sealed traction batteries with gas recombination or gel technology. The batteries must meet the requirements laid out in the norms: CEI EN 60254-1:2005-12 (CEI 21-5) + CEI EN 60254-2:2008-06 (CEI 21-7). For the best work results, we suggest the use of two 12V MFP 112 Ah/C₂₀ batteries.

BATTERY MAINTENANCE AND DISPOSAL

For battery maintenance and recharging, respect the instructions provided by the battery manufacturer. When the batteries reach the end of their service life, they must be disconnected by specialised and properly trained personnel, and must be subsequently removed from the battery compartment using suitable lifting devices.

(♻️) NB: dead batteries are classified as dangerous waste and as such must be delivered to an authorised body for disposal.

INSERTING THE BATTERIES IN THE MACHINE

The batteries must be housed in the relative compartment beneath the recovery tank. They should be handled using lifting equipment that is suitable in terms of both the weight and the coupling system.

(⚠️) DANGER: make sure you comply with the accident prevention regulations in force in the country where you work or with DIN EN 50272-3 and DIN EN 50110-1, before any handling of the batteries.

(⚠️) CAUTION: to prevent an accidental short circuit use insulated tools to connect the batteries, and do not place or drop metal objects on the battery. Remove rings, watches and any clothing with metal parts that may come into contact with the battery terminals.

The various phases for inserting the batteries in the battery compartment are as follows:

1. Make sure the machine is in a safe condition (see "[MACHINE SAFETY MEASURES](#)").
2. Grip the handle (1) and raise the recovery tank to the maintenance position (Fig.1).
3. House the batteries in the compartment, positioning the poles "+" and "-" opposite each other (Fig.2).

(📖) NB: for battery maintenance and daily recharging, you must fully respect the indications provided by the manufacturer or retailer.

(⚠️) WARNING: all installation and maintenance operations must be carried out by specialised personnel.

(i) NB: before installing the battery, clean the battery compartment. Check that the connectors on the cables supplied are functioning correctly.

(⚠️) WARNING: check that the characteristics of the battery that you are looking to use are appropriate for the type of work to be performed. Check the battery charge and the condition of the contacts on the battery.

(i) NB: you are advised to only lift and move the batteries with lifting and transportation means suitable for the specific weight and size

(⚠️) WARNING: the lifting hooks must not damage the blocks, connectors or cables.

(⚠️) WARNING: before inserting the batteries, remember to cover the terminals with a little grease to protect them against external corrosion.

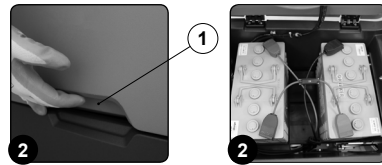

CONNECTING THE BATTERIES TO THE MACHINE SYSTEM

The batteries should be connected so as to obtain a total voltage of 24V.

(⚠️) ATTENTION: it is recommended that all installation and maintenance operations be carried out by expert personnel, trained at the specialised assistance centre.

(⚠️) CAUTION: to prevent an accidental short circuit use insulated tools to connect the batteries, and do not place or drop metal objects on the battery. Remove rings, watches and any clothing with metal parts that may come into contact with the battery terminals.

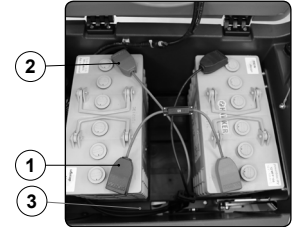

The various phases for inserting the batteries in the battery compartment are as follows:

1. Using the supplied jumper cable (1), connect the batteries to the "+" and "-" poles in sequence.
2. Connect the battery connector cable (2) to the "+" and "-" poles to obtain a voltage of 24V at the terminals.
3. Connect the electric system connector (3) to the battery connector (2).

RECHARGING THE BATTERIES

The batteries must be charged prior to first use, and whenever they no longer provide sufficient power.

(⚠️) ATTENTION: to avoid any permanent damage to the batteries, it is essential to avoid their complete discharge; begin recharging them within a few minutes of noting the "discharged batteries" signal.

(⚠️) ATTENTION: never leave the batteries completely discharged, even if the device is not being used.

1. Bring the appliance to the area where the batteries are charged.
2. Make sure the machine is in a safe condition (see "[MACHINE SAFETY MEASURES](#)").

(🏠) ATTENTION: park the machine in an enclosed place, on a flat and level surface; near the machine there must be no objects that could either damage it, or be damaged through contact with it.

(🏠) ATTENTION: the room used to recharge the batteries must be adequately ventilated to prevent the accumulation of gases that leak from batteries.

3. Grip the handle (1) on the right-hand side of the recovery tank (Fig.1) and turn the tank as far as it will go, until it reaches the maintenance position.

(⚠️) ATTENTION: the following operations must be carried out by qualified personnel. An incorrect connection of the connector may cause a malfunction of the device.

(📖) NB: carefully read the use and maintenance instructions of the battery charger used.

4. Go to the back of the machine and remove the cap (2) from the battery charger socket (Fig.2).
5. Connect the battery charger power cable connector (3) to the battery charger socket (4) (Fig.3).



(⚠️) CAUTION: before connecting the batteries to the battery charger, make sure it is suitable for the batteries used.

(⚠️) WARNING: before inserting the connector (3) in the socket (4), make sure there is no condensation or any other type of liquid.

(i) NB: the battery charger power cable is delivered inside the bag containing this instruction booklet.

6. Plug the battery charger cable into the mains socket.

(⚠️) CAUTION: keep the recovery tank open for the duration of the battery recharging cycle, to allow gas fumes to escape.

(📖) NB: before connecting the battery charger to the mains socket, make sure the characteristics of the mains supply correspond to those required by the battery charger. Read the battery charger use and maintenance manual (included in the bag that contains this instruction booklet).

7. When the recharge cycle is complete, disconnect the battery charger cable from the mains.
8. Disconnect the battery charger power cable from the socket on the battery charger itself.
9. Replace the cap (2) on the battery charger plug.
10. Grip the handle (1) on the right-hand side of the recovery tank and turn the tank as far as it will go, until it reaches the maintenance position.

ASSEMBLING THE BRUSH

For packaging reasons, the brushes are supplied disassembled from the machine. To assemble them on the brush head body, proceed as follows:

1. Make sure the machine is in a safe condition (see "[MACHINE SAFETY MEASURES](#)").
- CAUTION:** these operations must be carried out using protective gloves to avoid any possible contact with the edges or tips of metal objects.
2. Go to the front of the appliance.
3. If the splash guard carters (1) are fitted, remove them (Fig.1) and lay them carefully on the ground.
4. With the brush head UP, insert the brush in the plate housing underneath the brush head, turning it until the three buttons engage with the notches on the plate itself.
5. Press the brush-holder plate retainer (2) and simultaneously rotate the brush in the direction shown in the image (Fig.2).
- ATTENTION:** Fig.2 shows the rotation direction of the left-hand brush.
6. When brush rotation is prevented, turn until the button on the brush is engaged in the coupling spring on the brush-holder plate.
7. Reassemble the brush head splash guard carters.

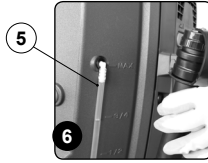
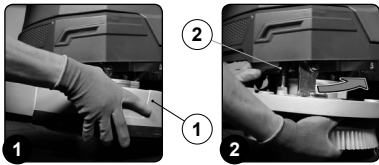

ASSEMBLING THE SQUEEGEE BODY

For packaging reasons, the squeegee body comes disassembled from the machine. To assemble it on the squeegee support, proceed as follows:

1. Make sure the machine is in a safe condition (see "[MACHINE SAFETY MEASURES](#)").
- CAUTION:** these operations must be carried out using protective gloves to avoid any possible contact with the edges or tips of metal objects.
2. Unscrew the knobs (1) in the squeegee body pre-assembly (Fig.1).
3. First of all, insert the left-hand pin (2) on the squeegee body in the left slit (3) in the squeegee support (Fig.2), so that the bushing adheres to the walls of the slit.
4. Repeat the same operation for the right-hand pin.
5. Insert the vacuum tube (4) in the sleeve (5) in the squeegee body (Fig.3).
- NB:** the squeegee has already been adjusted, but refer to "[ADJUSTING THE SQUEEGEE BODY RUBBER BLADES](#)" if you need any information.

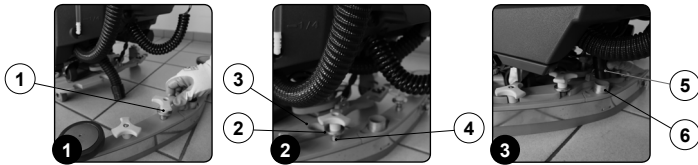

FILLING THE SOLUTION TANK WITH WATER

Before filling the solution tank, carry out the following steps:

1. Take the machine to the usual place for filling the solution tank.
2. Make sure the machine is in a safe condition (see "[MACHINE SAFETY MEASURES](#)").
3. Check the solution tank drainage cap (1) (on the rear right-hand side of the machine) is tight. If it isn't, turn it clockwise (Fig.1).
4. Check the water filter cap (2) (on the rear right-hand side of the machine) is tight. If it isn't, turn it clockwise (Fig.2).

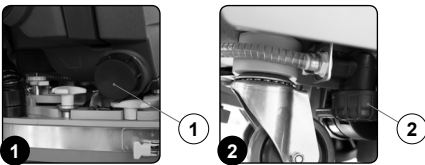

The solution tank can be filled with water in three different ways:

- Removing the cap/measuring device (3) (Fig.3) and filling the solution tank by means of a rubber tube or a bucket (Fig.4).
- Using the filler tube (4) (Fig.5), which supports the water tube on its own. In this case, remember to remove the cap/measuring device (3) to ensure the air is properly vented.
- Using the optional system for automatic clean water top-up. This system has a float for avoiding any overflow.



5. Fill with clean water, at a temperature no greater than 122°F and no less than 50°F. The amount inside the tank can be seen by means of the level tube (5) (Fig.6) on the rear left-hand side of the machine.

DETERGENT SOLUTION (VERSIONS WITHOUT HDC)

After filling the solution tank with clean water add the liquid detergent to the tank in the concentration and manner indicated on the detergent manufacturer's label. To prevent the formation of an excessive amount of foam that could damage the vacuum motor, use the minimum percentage of detergent required.

- CAUTION:** protective gloves should always be worn before handling detergents or acidic or alkaline solutions, to avoid serious injury to the hands.
- CAUTION:** always use detergents whose manufacturer's label indicates their suitability for scrubbing machines. Do not use acid or alkaline products or solvents without this indication.
- ATTENTION:** acid or alkaline maintenance detergents can be used, as long as they have pH values between 4 and 10, and do not contain: oxidising agents, chlorine or bromine, formaldehyde, mineral solvents. The detergents used must be suitable for use with scrubbing machines.
- CAUTION:** always use low-foam detergent. To avoid the production of foam, put a minimum quantity of antifoam liquid in the recovery tank before starting to clean. Do not use pure acids.
- NB:** to make it easier to measure the detergent on the cap/measuring device, there are notches indicating the detergent percentage quantities that can be used. The notches range from a minimum of 0.1% to a maximum of 0.5%.

FILLING THE DETERGENT CANISTER (VERSIONS WITH HDC)

After filling the solution tank with clean water, you must fill the detergent canister. Before filling the canister, carry out the following steps:

1. Take the machine to the usual place for filling the solution tank.
2. Make sure the machine is in a safe condition (see "[MACHINE SAFETY MEASURES](#)").
3. Grip the handle (1) on the right-hand side of the recovery tank (Fig.1) and turn the tank as far as it will go, until it reaches the maintenance position.
4. Disconnect the male insert (2) from the female insert (3) on the cap (4) of the detergent canister (5) (Fig.2).
- ATTENTION:** before pulling on the male insert, push the lever on the female insert.
5. Grip the handle (6) on the detergent canister (5) to remove it from the compartment in the solution tank (Fig.3).

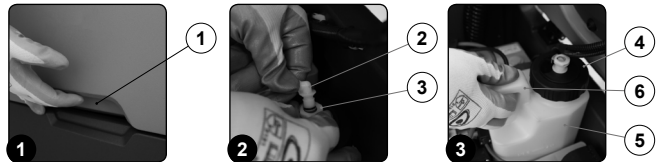

6. Remove the cap (4) from the detergent canister (Fig.4).
7. Fill the canister with the required detergent, as indicated on the label supplied with the machine.

- CAUTION:** protective gloves should always be worn before handling detergents or acidic or alkaline solutions, to avoid serious injury to the hands.
- WARNING:** always use low-foam detergent. To avoid the production of foam, put a minimum quantity of antifoam liquid in the recovery tank before starting to clean. Do not use pure acids.
- WARNING:** always use detergents whose manufacturer's label indicates their suitability for scrubbing machines. Do not use acid or alkaline products or solvents without this indication.
- ATTENTION:** the dosing system is suitable for frequent maintenance cleaning. acid or alkaline maintenance detergents can be used, as long as they have pH values between 4 and 10, and do not contain: oxidising agents, chlorine or bromine, formaldehyde, mineral solvents. The detergents used must be suitable for use with scrubbing machines. Wash the circuit with water after use if the system is not used daily. The system can be excluded. In case of sporadic use of detergents with pH between 1-3 or 11-14, use the floor scrubbing machine in the traditional way by adding the detergent in the clean water tank and excluding the dosing circuit.

8. Make sure you tighten the cap (4) properly to avoid any leakage of liquid while working. Make sure the detergent suction filter (7) is correctly positioned on the bottom of the canister (Fig.5).
9. Grip the canister handle (6) to replace the canister (5) in its compartment inside the solution tank.
10. Connect the male insert (2) to the female insert (3) in the cap (4) of the detergent canister (5).
11. Grip the handle (1) on the right-hand side of the recovery tank and turn the tank as far as it will go, until it reaches the work position.

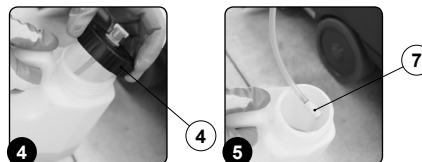

PREPARING TO WORK

Before beginning to work, it is necessary to:

1. Make sure the recovery tank is empty. If it isn't, empty it (see ["EMPTYING THE RECOVERY TANK"](#)).
2. Check that the amount of detergent solution in the solution tank is sufficient for the type of work to be performed. If it isn't, top up the solution tank (see ["FILLING THE SOLUTION TANK WITH WATER"](#) and ["DETERGENT SOLUTION"](#)). Check the level tube (1) in the rear left-hand part of the machine (Fig.1).
3. Check the rubber squeegee blades are in good working condition. If they aren't, replace them (see ["REPLACING THE SQUEEGEE BODY RUBBER BLADES"](#)).
4. Check the brush is in good working condition. If it isn't, replace it (see ["REPLACING THE BRUSH HEAD BRUSH"](#)).
5. Check the machine is switched off. If it isn't, turn the main switch (2) to "0" by rotating the key a quarter turn in the direction of the arrow (Fig.2). Remove the key from the instrument panel.
6. Grip the handle (3) on the right-hand side of the recovery tank (Fig.3) and turn the tank as far as it will go, until it reaches the maintenance position.



7. Connect the main system connector (4) to the battery connector (5) (Fig.4).

ATTENTION: this process must be carried out by qualified personnel.

8. Grip the handle (3) on the right-hand side of the recovery tank and turn the tank until it reaches the work position.
9. Make sure the electronic brake is engaged. If it isn't, turn the lever (6) in the direction of the arrow. The traction gearmotor is located on the rear right-hand side of the machine (Fig.5).
10. Check the water tap is fully open - the water adjustment knob (7) must be turned fully in the direction shown by the arrow (Fig.6).

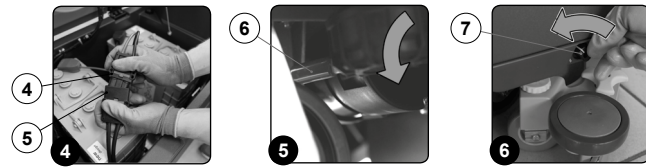

11. Make sure the solution tank drainage cap (8) is closed. If it isn't, close it (Fig.7).
12. Make sure the water filter cap (9) is closed. If it isn't, close it (Fig.8).
13. Make sure the cap of the recovery tank drainage tube (10) is closed. If it isn't, close it (Fig.9).

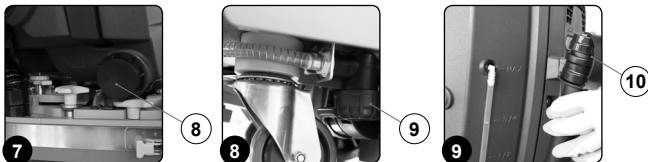

14. Make sure the vacuum tube (11) is correctly connected to the sleeve in the squeegee body. If it isn't, connect it (Fig.10).
15. Make sure the vacuum motor filter (12) is correctly connected and is clean (Fig.11). If it isn't, clean it (see ["CLEANING THE RECOVERY TANK FILTERS"](#)).
16. Make sure the filter basin (13) is correctly connected and is clean (Fig.12). If it isn't, clean it (see ["CLEANING THE RECOVERY TANK FILTERS"](#)).
17. Make sure the recovery tank cover is properly closed. If it isn't, close it.

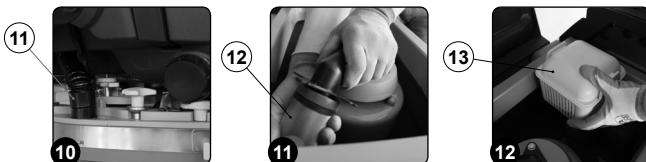

WORK

To start working, proceed as follows:

1. Make all the checks listed in ["PREPARING TO WORK"](#).
2. Sit on the driver's seat.
3. Insert the key (1) in the main switch on the control panel. Set the main switch to "I" by making a quarter turn of the key to the right (Fig.1).
4. The first and second screen displayed allow you to check the software versions of the functions board and display board.
5. A few seconds after ignition, the password screen is displayed (Fig.2).
6. Enter the password and press Enter (2) (Fig.2).

NB: if you make a mistake, press Delete (3) (Fig.2).

NB: the password entered by the manufacturer is 0000.

NB: it is possible to disable the password entry. Contact your nearest HILLYARD assistance centre.

NB: the password to be entered (selected by the manufacturer) is 0000.

7. If the password is correct, the "MAIN" screen will be displayed (Fig.3).

NB: by default the machine is set to the transfer program (Fig.3).



8. Select the required working program with the DS selector device (see ["DS SELECTOR"](#)).
9. Select the required work area and press the "ZONE" key (see ["ZONE PROGRAM BUTTON"](#)).
10. When you push the dead man's lever (4) (Fig.4), the machine will begin to move.

If the program selected is "SCRUBBING WITH DRYING", the squeegee and brush head will lower until they touch the floor.

As soon as the drive pedal is pressed, the traction motor, brush head motor and vacuum motor will start working. As a result, the solenoid valve will also be activated and detergent solution will be dispensed onto the brushes.

During the first few metres, check that there is sufficient solution and that the squeegee is drying correctly.

The appliance will now begin to work with full efficiency until the battery is flat or until the detergent solution has finished.

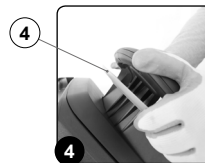

TRANSFER

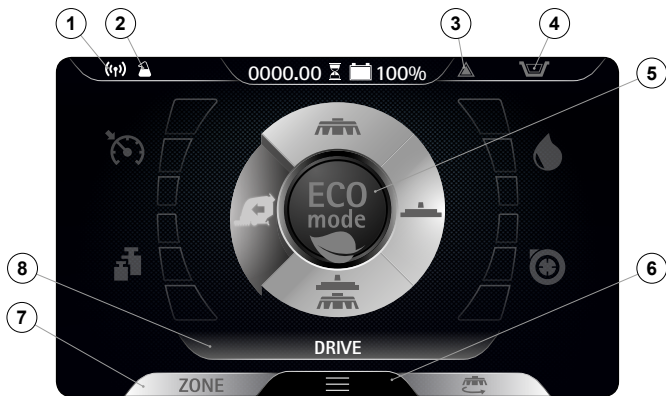

Selecting the program "TRANSFER", the control display screen will appear as shown in the figure.

- ① **NB:** with this working program, both the brush head and squeegee support are in the idle position (raised off the floor) and the motors switch off with the respective switch-off delays (even if the drive pedal is not pressed). When the dead man's lever is pressed, only the traction motor is powered.
- ② **NB:** on the DS selector, the symbol of the transport program (A) is green.
- ③ **NB:** the grey symbols show working programs that are not active, the green symbols show working programs that are active.

The icons that may be visible are:

1. HFM symbol. If visible, it indicates that the "HILLYARD FLEET MANAGEMENT" system is active.
2. HDC symbol. If visible, it indicates that the "HILLYARD DOSING CONTROL" system is active.
3. General alarm symbol.

⚠ ATTENTION: if visible, stop the machine. To continue working, see "ALARM SCREEN".

4. Solution tank empty float symbol.

⚠ ATTENTION: if visible, it indicates that the detergent solution in the tank has reached a level beyond which the solenoid valve cannot deliver solution onto the brushes, so the tank needs to be filled up before continuing the work (see "FILLING THE SOLUTION TANK").

5. HEM button.

⑥ **NB:** if the Eco-Mode button (5) is pressed in transfer mode, the "scrubbing with drying" program is activated in economic mode.

6. Menu button.
7. Zone button.

⑧ **NB:** if the Zone button (8) is pressed in transfer mode, the window for selecting the zone opens (see "ZONE PROGRAM BUTTON"). Once you have selected an area, "scrubbing with drying" is activated for the area selected.

8. Text indicator.

⑧ **NB:** the text indicator (8) shows which zone program has been selected, or whether the machine is in transport mode if the word "DRIVE" is visible.

SCRUBBING WITHOUT DRYING

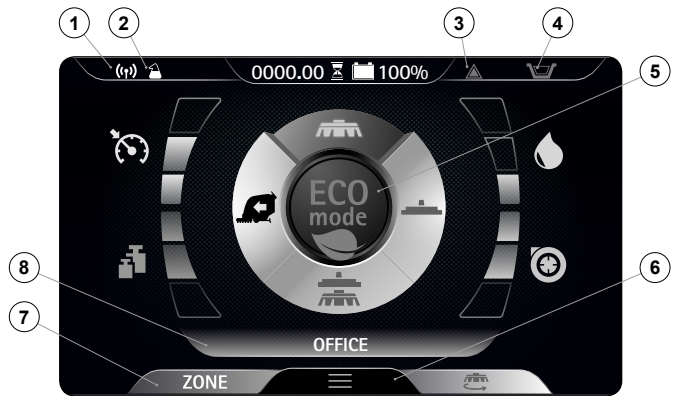

Selecting the program "SCRUBBING WITHOUT DRYING", the control display screen will appear as shown in the figure.

- ① **NB:** with this working program, the pressing of the dead man's lever only brings the brush head to the work position (in contact with the floor); the squeegee remains in the idle position (raised from the floor). The brush head solenoid valve and the water system pump are powered up (only if the detergent solution is other than zero). When the dead man's lever is pressed, the brush head, solenoid valve, electric pump and traction motor are powered.

② **NB:** on the DS selector, the symbol of the "scrubbing without drying" program (B) is green.

③ **NB:** the grey symbols show working programs that are not active, the green symbols show working programs that are active.

④ **NB:** when the dead man's lever is released, the brush head motor stops with the relative delay. After the "Reset Delay" time, the brush head is taken to its idle position (raised off the floor). When the dead man's lever is pressed, work will resume with the same working program and parameters used prior to the stop.

⑤ **NB:** if you reverse while this program is active, the brush head body will remain in contact with the floor and the motor will continue working, but the solenoid valve will not deliver detergent solution to the brushes.

The icons that may be visible are:

1. HFM symbol. If visible, it indicates that the "HILLYARD FLEET MANAGEMENT" system is active.
2. HDC symbol. If visible, it indicates that the "HILLYARD DOSING CONTROL" system is active.
3. General alarm symbol.

⚠ ATTENTION: if visible, stop the machine. To continue working, see "ALARM SCREEN".

4. Solution tank empty float symbol.

⚠ ATTENTION: if visible, it indicates that the detergent solution in the tank has reached a level beyond which the solenoid valve cannot deliver solution to the brushes, so the tank needs to be filled up before continuing the work (see "FILLING THE SOLUTION TANK").

5. HEM button.

⑥ **NB:** if the Eco-Mode button (5) is pressed in transfer mode, the "scrubbing with drying" program is activated in economic mode.

6. Menu button.
7. Zone button.

⑧ **NB:** if the Zone button (8) is pressed in transfer mode, the window for selecting the area opens (see "ZONE PROGRAM BUTTON"). Once you have selected an area, "scrubbing with drying" is activated for the area selected.

8. Text indicator.

⑧ **NB:** the text indicator (8) shows which zone program has been selected, or whether the machine is in transport mode if the word "DRIVE" is visible.

⚠ ATTENTION: never switch off the machine while the brush head is in contact with the floor

DRYING

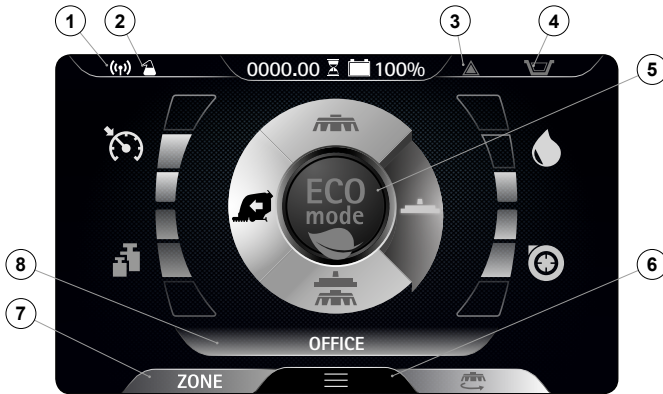

Selecting the program "DRYING", the control display screen will appear as shown in the figure.

- i** **NB:** with this working program, the pressing of the dead man's lever only brings the squeegee to the work position (in contact with the floor); the brush head remains in the idle position (raised from the floor). When the dead man's lever is pressed, both the vacuum motor and the traction motor are powered.
- i** **NB:** on the DS selector, the symbol of the drying program (C) is green.
- i** **NB:** the grey symbols show working programs that are not active. the green symbols show working programs that are active.
- i** **NB:** when the dead man's lever is released, the vacuum motor stops with the relative delay. After the "Reset Delay" time, the squeegee support is taken to its idle position (raised off the floor). When the dead man's lever is pressed, work will resume with the same working program and parameters used prior to the stop.
- i** **NB:** if you reverse while this program is active, the squeegee support is taken to its idle position (raised off the floor) and the vacuum motor is switched off with the relative delay.

The icons that may be visible are:

1. HFM symbol. If visible, it indicates that the "HILLIARD FLEET MANAGEMENT" system is active.
2. HDC symbol. If visible, it indicates that the "HILLIARD DOSING CONTROL" system is active.
3. General alarm symbol.

! ATTENTION: if visible, stop the machine. To continue working, see "ALARM SCREEN".

4. Solution tank empty float symbol.

! ATTENTION: if visible, it indicates that the detergent solution in the tank has a reached a level beyond which the solenoid valve cannot deliver solution onto the brushes, so the tank needs to be filled up before continuing the work (see "FILLING THE SOLUTION TANK").

5. HEM button.

i **NB:** if the Eco-Mode button (5) is pressed in transfer mode, the "scrubbing with drying" program is activated in economic mode.

6. Menu button.
7. Zone button.

i **NB:** if the Zone button (8) is pressed in transfer mode, the window for selecting the zone opens (see "ZONE PROGRAM BUTTON"). Once you have selected an area, "scrubbing with drying" is activated for the area selected.

8. Text indicator.

i **NB:** the text indicator (8) shows which zone program has been selected, or whether the machine is in transport mode if the word "DRIVE" is visible.

! ATTENTION: the drying without scrubbing operation should only be carried out if the device was used beforehand to carry out a scrubbing without drying operation.

! ATTENTION: never switch off the machine with the squeegee in contact with the floor

SCRUBBING WITH DRYING



Selecting the program "SCRUBBING WITH DRYING", the control display screen will appear as shown in the figure.

- i** **NB:** with this working program, the pressing of the dead man's lever brings both the brush head and the squeegee to the work position (in contact with the floor). When the dead man's lever is pressed, all the motors are powered. The brush head solenoid valve and the water system pump are powered up (only if the detergent solution level is not at zero).
- i** **NB:** on the DS selector, the symbol of the scrubbing with drying program (D) is green.
- i** **NB:** the grey symbols show working programs that are not active. the green symbols show working programs that are active.
- i** **NB:** when the dead man's lever is released, the brush head motor and the vacuum motor stop with the relative delays. After the "Reset Delay" time, the brush head and squeegee body are taken to their idle position (raised off the floor). When the dead man's lever is pressed, work will resume with the same working program and parameters used prior to the stop.
- i** **NB:** if you reverse while this program is active, the brush head body will remain in contact with the floor and the motor will continue working, but the solenoid valve will not deliver detergent solution to the brushes. The squeegee support is taken to its idle position (raised off the floor) and the vacuum motor is switched off with the relative delay.

The icons that may be visible are:

1. HFM symbol. If visible, it indicates that the "HILLIARD FLEET MANAGEMENT" system is active.
2. HDC symbol. If visible, it indicates that the "HILLIARD DOSING CONTROL" system is active.
3. General alarm symbol.

! ATTENTION: if visible, stop the machine. To continue working, see "ALARM SCREEN".

4. Solution tank empty float symbol.

! ATTENTION: if visible, it indicates that the detergent solution in the tank has a reached a level beyond which the solenoid valve cannot deliver solution onto the brushes, so the tank needs to be filled up before continuing the work (see "FILLING THE SOLUTION TANK").

5. HEM button.

i **NB:** if the Eco-Mode button (5) is pressed in transfer mode, the "scrubbing with drying" program is activated in economic mode.

6. Menu button.
7. Zone button.

i **NB:** if the Zone button (8) is pressed in transfer mode, the window for selecting the zone opens (see "ZONE PROGRAM BUTTON"). Once you have selected an area, "scrubbing with drying" is activated for the area selected.

8. Text indicator.

i **NB:** the text indicator (8) shows which zone program has been selected, or whether the machine is in transport mode if the word "DRIVE" is visible.

! ATTENTION: never switch off the machine with the squeegee and/or brush head in contact with the floor

DS SELECTOR (DRIVE SELECT)

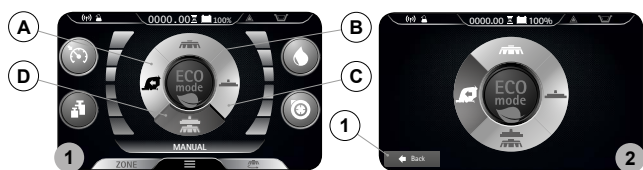

The DS selector can be used to select one of the following working programs:

- A. Transfer: movement of the machine without working.
- B. Scrubbing only: using only the brushes in the brush head.
- C. Drying: using the squeegee only.
- D. Scrubbing with Drying: using both the brushes and the squeegee.

Pressing one of the symbols in the selector, you pass from the working screen (Fig. 1) to the program selection screen (Fig. 2). On this screen it is possible to:

1. Confirm the selected program.

(i) NB: to confirm the program, press the selected icon again.

(i) NB: once the selection has been confirmed, you will return to the working screen (Fig. 1).

2. Cancel the selection and return to the working screen

(i) NB: to cancel the selection, press the "back" button (1) (Fig. 2) to return to the working screen without changing the current program.

(i) NB: to cancel the selection, wait 5 seconds without selecting anything and you will return to the working screen without changing the current program.

3. Select a mode other than the one highlighted.

ECO MODE



In the centre of the DS selector there is the ECO-MODE key (1). Press it to activate the economic function that provides the best possible performance in terms of consumption and cleaning.

(i) NB: if the ECO-MODE key (1) is pressed in any working program, you will pass from ZONE mode (Fig. 1) to economic mode (Fig. 2).

(i) NB: A grey ECO-MODE key means that economic mode is not active. A green ECO-MODE key means that economic mode is active.

(i) NB: in ECO-MODE, the ZONE button is not active.

(i) NB: if you press key (1) in the transfer mode, you automatically pass to economic "scrubbing with drying" mode with the program selector.

(i) NB: if the ECO-MODE key (1) is pressed in any working program while eco mode is active, you will pass from ECO-MODE (Fig. 2) to MANUAL MODE (Fig. 3).



MANUAL MODE



In the middle of the DS selector there is the ECO-MODE button (1). If you press the button (1) in any eco-mode program, you will pass from ECO mode to MANUAL mode, with manual management of the individual parameters.

(i) NB: A grey ECO-MODE key means that economic mode is not active. A green ECO-MODE key means that economic mode is active.

(i) NB: in MANUAL MODE, the ZONE and ECO buttons are not active.

In manual mode, the visible buttons are:

2. Detergent solution adjustment.
3. Vacuum motor performance level.
4. Pressure exerted on the central brush head.

5. Maximum forward movement speed level.

(i) NB: the four keys are always present, but can only be used depending on the working mode selected. In particular:

- Transfer: the visible button will be that of maximum speed.
- Scrubbing without drying: the buttons visible will be those of maximum speed, detergent solution adjustment and pressure exerted on the central brush head.
- Drying: the buttons visible will be those of maximum speed and vacuum motor performance level.
- Scrubbing with Drying: the buttons visible will be those of maximum speed, detergent solution adjustment, pressure exerted on the central brush head, and vacuum motor performance level.

(i) NB: the disabled buttons and the respective indicators are grey.

(i) NB: every time one of the enabled keys is pressed, the relative level is cyclically increased. Only the detergent solution adjustment can have a zero level.

ZONE PROGRAM BUTTON

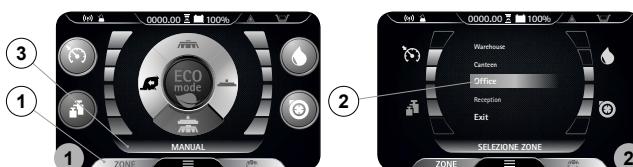

The zone programs are programs saved in the machine memory. The following parameter levels:

- Pressure exerted on the brush head
- Forward speed
- Adjustment of the detergent solution flow
- Vacuum motor performance

are fixed, and have been created based on the type of environment in which you want to work. To select one of the zone programs, proceed as follows:

1. From any screen, press the "ZONE" button (1) (Fig. 1).
2. As soon as the button (1) is pressed, the "ZONE SELECTION" menu will be displayed (Fig. 2). Select one of the programs.

(i) NB: the name of the zone program selected is displayed in the text indicator (3) (Fig. 1).

(i) NB: to quit the zone program:

- From the zone program menu, select the "EXIT" key
- Enable and then disable the ECO-MODE key.

(i) NB: the light blue ZONE key shows that the selected zone is active. In this case, the ECO-MODE button is not active.

REVERSE

This machine is equipped with electronic traction control. To reverse, proceed as follows:

1. Press the "REVERSE ACTIVATION - DEACTIVATION" button (1) on the control handlebars (Fig. 1).
2. Press the dead man's lever (2) (Fig. 2) to start the machine moving in reverse.

(i) CAUTION: reverse speed is lower than forward speed, to comply with current health and safety standards.

(i) NB: to disable reverse movement, press the button (1) on the control handlebars again (Fig. 1).

(i) NB: as soon as the button (1) is pressed, the buzzer will sound to indicate that reverse mode has been activated.

(i) NB: if reverse gear is engaged with the squeegee in its working position, the machine will begin moving backwards as soon as the dead man's lever is pressed, and the squeegee body will rise to its idle position.

(i) NB: if reverse gear is engaged with the brush head in its working position, the machine will begin moving backwards as soon as the dead man's lever is pressed, and the brush head body will remain in its working position, but the solenoid valve will stop dispensing detergent solution.

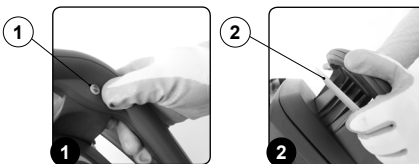

EXTRA BRUSH HEAD PRESSURE

This machine is capable of increasing the pressure exerted upon the brushes during the work cycle. This can be done in the following manner:

1. Check that the brush head body is in contact with the floor. If it isn't, use the DS selector to select "SCRUBBING WITH DRYING" or "SCRUBBING WITHOUT DRYING" (Fig.1).
2. Press the "EXTRA PRESSURE ACTIVATION - DEACTIVATION" button (1) on the control handlebars (Fig.2).
3. Press the dead man's lever (2) (Fig.3) to start the working cycle.

NB: as soon as the button (1) is pressed, the control display will show the "POWER" screen (Fig.4). In the middle of the screen there is a graphic symbol (3) and a numeric symbol (4) that represent a countdown.

NB: when the extra-pressure function is activated, the countdown starts. During this time, a pressure stronger than the standard pressure is exerted on the brush head body.

NB: at the end of the countdown, you return to the working screen that was previously used and the pressure on the brush head goes back to standard.

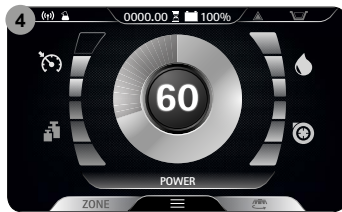
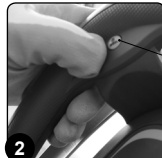

HILLYARD DOSING CONTROL (HDC) SYSTEM

Upon request, the machine can be fitted with HILLYARD DOSING CONTROL (HDC), a system that allows the detergent and water in the solution tank to be measured out separately. To activate it, proceed as follows.

1. With the machine on, press the menu button (1) on the working screen (Fig.1).
2. Press the HDC system activation/deactivation button (2) (Fig.2).

NB: if the symbol (2) is grey, the HDC system is not active; if the symbol (2) is green, the HDC system is active.

NB: to quit the menu screen, wait a short time without pressing anything, or else press on any point of the display (except one of the displayed buttons).

NB: the HDC system is activated when the electric pump in the machine water system starts up.

NB: if the HDC system is activated, the relative symbol (3) is displayed in the working screen.

NB: if you want to deactivate the HDC system, press the button (2) again.

ATTENTION: before starting any work, remember to start up the HDC system.

NB: to return to the working screen, press on any point of the screen (except the edges of the display) or else wait three seconds without touching anything.



TUTORIAL

The machine function board contains a memory card with lessons that explain:

- the first machine start-up.
- routine maintenance to be carried out on the machine.
- the machine use and maintenance manual.

To activate them, proceed as follows.

1. With the machine on, press the menu button (1) on the working screen (Fig.1).
2. Press the TUTORIAL button (2) (Fig.2).

NB: to return to the working screen, press on any point of the screen (except the edges of the display) or else wait three seconds without touching anything.



3. On the tutorial screen (Fig.3), select the topics you want to study:

- A. Using the machine.
- B. Daily maintenance.
- C. Extraordinary maintenance.

NB: select the "USING THE MACHINE" key (A) to see the video explaining the stages for preparing the machine for work (Fig.3).

NB: select the "DAILY MAINTENANCE" key (B) to see the video explaining the maintenance to be carried out every day (Fig.3). When this button is selected, the screen regarding the selection of the videos to view will be displayed (Fig.4). You can view the following tutorial videos:

- Draining and cleaning the recovery tank.
- Cleaning the vacuum tube and squeegee body.
- Cleaning the vacuum motor filter.
- Draining and cleaning the solution tank and water system filter.

NB: select the "EXTRAORDINARY MAINTENANCE" key (C) to see the video explaining the maintenance to be carried out daily (Fig.3). When this button is selected, the screen regarding the selection of the videos to view will be displayed (Fig.4). You can view the following tutorial videos:

- Replacing the squeegee rubber blades.
- Replacing the brush head brushes.
- Adjusting the squeegee rubber blades.



EMERGENCY SWITCH

This machine is equipped with an emergency switch. To activate it, just press the button (1) on the back of the control handlebars (Fig.1).

WARNING: this control interrupts the electrical circuit between the batteries and the machine system.

NB: after stopping and resolving the problem, turn the key to "0", set the button (1) to the standard position and turn the key to "1" to resume the work.

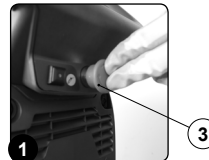

HOUR METER

The control display is in the control panel. At the centre top, you can see the total time the machine has been used.

The numbers before the "." symbol identify hours, while the number after it indicates hour decimals (an hour decimal corresponds to six minutes).

When the "hour glass" symbol (1) is flashing, it indicates that the hour meter is counting the appliance operating time.

BATTERY CHARGE LEVEL INDICATOR

The control display is in the control panel. At the centre top, you can see the battery charge level.

The indicator is composed of two charge level symbols, the first represented by a graphic symbol (2) and the second by a number indicating the charge percentage (3).

With a low charge level, the graphic symbol (2) will start to flash and after a few seconds it will switch off. In these conditions, take the machine to the place where its batteries can be charged.

NB: a few seconds after the battery charge reaches the critical level, the brush gearmotors switch off automatically. With the remaining charge, it is possible to complete the drying process before starting the recharging process.

NB: a few seconds after the battery charge reaches the discharge level, the vacuum motor switches off automatically.

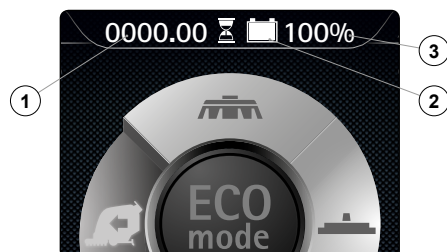

VACUUM WAND KIT

Upon request, the machine can be fitted with the VACUUM WAND system that vacuums up the detergent solution more accurately. To activate it, proceed as follows.

- Using the DS selector on the control display (Fig.1), select the "transfer program" (1).
- Remove all the vacuum kit components from the storage compartment (Fig.2). To open the storage compartment, use the handle (2) on the front of the control handlebars.
- Assemble the steel extension tube (Fig.3).



- Connect the vacuum tube (4) to the extension tube (3) (Fig.4).
- Insert the vacuum brush (5) in the extension tube (3) (Fig.5).
- Remove the vacuum tube (6) from the sleeve (7) in the squeegee body (Fig.6).

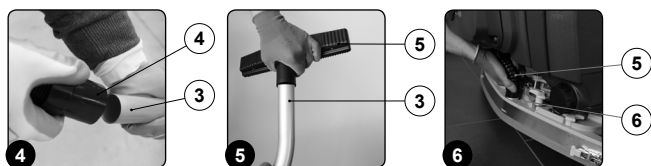

- Connect the wand kit vacuum tube (4) to the squeegee vacuum tube (5) (Fig.7).
- Activate the vacuum control kit by pressing the button (7) (Fig.8).

- NB:** as soon as the button (7) is pressed, the LED on it will light up (Fig.8).
- NB:** as soon as the button (7) on the control display is pressed, the symbol (8) will appear (Fig.9).



- WARNING:** never pick up solid matter such as dust, cigarette stubs, paper, etc.
- CAUTION:** never collect gases, explosive/inflammable liquids or powders, nor acids and solvents! These include gasoline, paint thinners and fuel oil (which, when mixed with the vacuum air, can form explosive vapours or mixtures), and also non-diluted acids and solvents, acetones, aluminium and magnesium powders. These substances may also corrode the materials used to construct the machine.
- CAUTION:** if the machine is used in dangerous areas (e.g. petrol stations), the relative safety standards must be observed. It is forbidden to use the machine in environments with a potentially explosive atmosphere.

- After completing the task, the wand kit can be fixed in the side support on the machine (Fig.13).

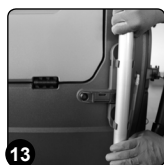

SMART DRYING SYSTEM

The machine has a function called "SMART DRYING": shifting from the program that includes drying (scrubbing with drying, or drying only) to the transfer program, this function delays the rise of the squeegee coupling for max. 10 seconds, until the machine has moved another 3 metres.

- NB:** as long as this function is active, the control display will visualise the relative screen (Fig.1).
- NB:** when the function terminates, the control display will visualise the relative screen (Fig.2) and the actuator will bring the squeegee to its idle position.
- NB:** to annul this function, press the "X" key on the screen (Fig.1).



SOLUTION TANK OVERFLOW

The machine is equipped with a mechanical device (float) under the recovery tank lid that, when the recovery tank is full, shuts off the air to the vacuum motor intake to protect it; the sound of the vacuum motor will then be deeper.

If this is the case, proceed as follows:

- From the DS control panel, select TRANSFER mode (A) (Fig.1).
- Bring the machine to the designated place for emptying the recovery tank.
- Switch off the machine by making a quarter turn to the left with the key (1) of the main switch (Fig.2).
- Empty the recovery tank (see "EMPTYING THE RECOVERY TANK").

- NB:** the machine will only resume correct operation after the next start-up.



ALARM SCREEN

When an error occurs, the symbol (1) is displayed in the information field (Fig.1). It remains visible until the error has been resolved.

The "ERROR" window will also be superimposed on the screen (Fig.2). It shows the alarm number, the membership group, and a brief description.

When an error occurs, proceed as follows:

- Stop the machine and press the button (2) (Fig.2).
 - If the error persists, switch off the machine and wait at least ten seconds before switching it back on.
 - If the error persists, contact your nearest service centre.
- NB:** to close the error screen, press the button (3) (Fig.2).
 - NB:** the symbol (1) (Fig.1) remains visible until the error has been resolved.
 - NB:** if the machine is fitted with the HFM (HILLYARD FLEET MANAGEMENT) system, it will send an e-mail to the affiliated service centre.

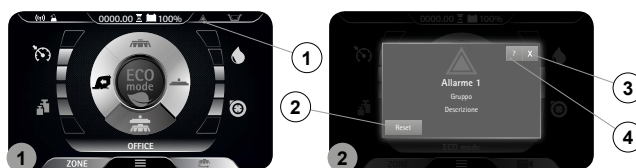

AT THE END OF THE WORK

At the end of the work, and before carrying out any type of maintenance, perform the following operations:

- From the DS control panel, select TRANSFER mode (A) (Fig.1).
- When you push the dead man's lever (1) (Fig.2), the machine will begin to move.
- Take the appliance to the dedicated dirty water drainage area.



- Switch off the machine by turning the key (2) of the main switch to the left (Fig.3). Remove the key from the instrument panel.
- Carry out all the procedures listed in "RECOMMENDED PERIODIC MAINTENANCE" (in the "AT THE END OF THE WORK" column).
- Insert the key (2) in the main switch on the control panel. Set the main switch to "I", turning the key (2) to the left (Fig.4).
- When you push the dead man's lever (1) (Fig.2), the machine will begin to move.
- Take the appliance to the designated machine storage place.

- ATTENTION:** park the machine in an enclosed place, on a flat surface, and at a safe distance from any objects that could either damage it or be damaged due to contact with the machine itself.

- Make sure the machine is in a safe condition (see "MACHINE SAFETY MEASURES").

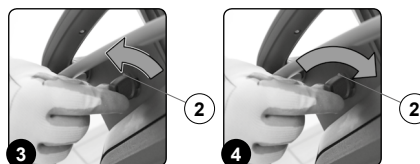

RECOMMENDED MAINTENANCE OPERATIONS

TYPE OF MAINTENANCE	AT THE END OF THE WORK	DAILY	WEEKLY	BEFORE A LONG PERIOD OF NON-USE	TRANSPORT
EMPTYING THE RECOVERY TANK	X			X	X
CLEANING THE SQUEEGEE BODY	X	X		X	
CLEANING THE BRUSH HEAD BRUSH		X		X	
CLEANING THE RECOVERY TANK FILTERS		X		X	
CLEANING THE RECOVERY TANK			X	X	
EMPTYING THE SOLUTION TANK			X	X	X
CLEANING THE WATER SYSTEM FILTER			X	X	
CLEANING THE VACUUM TUBE			X	X	
CLEANING THE SOLUTION TANK			X	X	
CLEANING THE VACUUM WAND KIT			X	X	

EMPTYING THE RECOVERY TANK

Proceed as follows to empty the recovery tank:

1. Take the machine to the maintenance area.
2. Make sure the machine is in a safe condition (see "MACHINE SAFETY MEASURES").

CAUTION: users are advised to always wear protective gloves, to avoid the risk of serious injury to hands.

3. Release the recovery tank drainage tube (on the back of the machine) from the retainers (Fig.1).
4. Bend the end of the drainage tube in order to create a choke and prevent the content from coming out (Fig.2), then position the tube on the discharge surface, unscrew the cap, and gradually release the tube.

NB: the place designated for this operation must comply with current environmental protection regulations.

5. Repeat the operations in reverse order to reassemble all the parts.



CLEANING THE SQUEEGEE BODY

The careful cleaning of the whole vacuum unit ensures better drying and cleaning of the floor as well as a longer vacuum motor life. To clean the squeegee body, proceed as follows:

1. Take the machine to the maintenance area.
2. Make sure the machine is in a safe condition (see "MACHINE SAFETY MEASURES").

CAUTION: these operations must be carried out using protective gloves to avoid any possible contact with the edges or tips of metal objects.

3. Remove the vacuum tube (1) from the vacuum nozzle on the squeegee body (Fig.1).
4. Completely unscrew the knobs (2) in the squeegee body pre-assembly (Fig.2).
5. Remove the squeegee body from the slits in the squeegee connector (Fig.3).

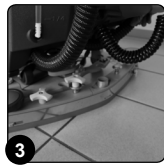
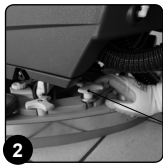
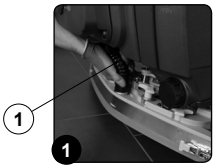

6. Thoroughly clean the vacuum chamber of the squeegee body, first with a jet of water and then with a damp cloth.

NB: the place designated for this operation must comply with current environmental protection regulations.

7. Thoroughly clean the rear rubber blade of the squeegee body, first with a jet of water and then with a damp cloth.
8. Thoroughly clean the front rubber blade of the squeegee body, first with a jet of water and then with a damp cloth.
9. Thoroughly clean the vacuum nozzle with a jet of water, and then with a damp cloth.
10. Proceed in reverse order to reassemble all the parts.

CLEANING THE BRUSH HEAD BRUSH

Careful cleaning of the brush guarantees better cleaning of the floor, as well as a longer brush head gearmotor lifespan. To clean the brush, proceed as follows:

1. Take the machine to the maintenance area.
2. Make sure the machine is in a safe condition (see "MACHINE SAFETY MEASURES").
3. Go to the front of the machine.
4. Remove the splash guard carters (1) (Fig.1) and lay them carefully on the ground.
5. Press the brush-holder plate retainer (2) and simultaneously rotate the brush (3) in the direction shown in the image (Fig.2).

ATTENTION: Fig.2 shows the rotation direction of the left-hand brush.

6. When brush rotation is prevented, turn until the button on the brush is disengaged from the coupling spring on the brush-holder plate.
7. Repeat the same operation for the right-hand brush.
8. Clean the brush under running water to remove any impurities from its bristles. Check the bristles are not worn; in the event of excessive wear, replace the brush (the bristles should be at least 10mm long). When replacing the brush, read "REPLACING THE BRUSH HEAD BRUSH".

ATTENTION: these operations must be carried out using protective gloves to avoid any possible contact with the edges or tips of metal objects.

ATTENTION: the place designated for this operation must comply with current environmental protection regulations.

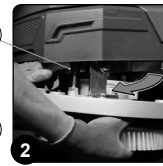

CLEANING THE RECOVERY TANK FILTERS

To clean the recovery tank filters (without the optional tank cleaning kit), proceed as follows:

1. Take the machine to the maintenance area.
2. Make sure the machine is in a safe condition (see "MACHINE SAFETY MEASURES").

CAUTION: users are advised to always wear protective gloves, to avoid the risk of serious injury to hands.

NB: the place designated for this operation must comply with current environmental protection regulations.

3. Grip the handle (1) on the left-hand side of the recovery tank (Fig.1) and turn the tank cover as far as it will go, until it reaches the maintenance position.
4. Remove the dirty water basket/filter (2) from the support (Fig.2).
5. Remove the basket cover (3) from the basket/filter (2) (Fig.3).

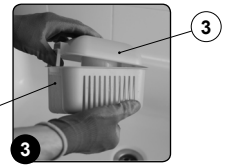
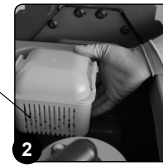
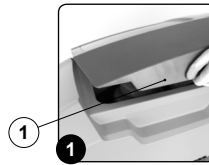

6. Clean the basket/filter (2) and the basket cover (3) under a jet of water.

NB: use a spatula or brush to eliminate any dirt that is particularly difficult to remove.

7. Use a dry cloth to dry the basket/filter (2) and the basket cover (3) and place them back inside the recovery tank.
8. Remove the filter protection cup (4), turning it in the direction of the arrow (Fig.4).
9. Remove the vacuum motor filter (5), taking care not to lose the support tie (6) inside the recovery tank (Fig.5).
10. Rinse the cup (4) and filter (5) thoroughly under running water.

NB: use a spatula to eliminate any dirt that is particularly difficult to remove.

11. Repeat the operations in reverse order to refit everything.

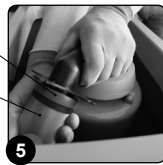
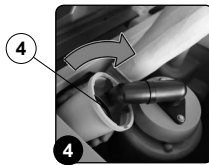

To clean the recovery tank filters (with the optional tank cleaning kit), proceed as follows:

1. Take the machine to the maintenance area.

CAUTION: users are advised to always wear protective gloves, to avoid the risk of serious injury to hands.

2. Release the tank cleaning accessory (1) (at the back of the machine) from the retainers (Fig.1).
3. Activate the optional tank cleaning kit ON/OFF pump by pressing the button (2) on the back of the machine (Fig.2).

CAUTION: when using the optional tank cleaning kit, you are advised to always wear goggles to avoid any risk of serious injury to your eyes.

NB: before activating the optional tank cleaning kit, check the level indicator (3) to see how much solution there is in the recovery tank (Fig.3).

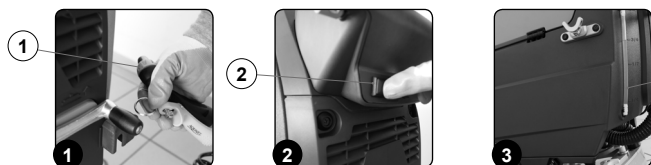

4. Activate the solution jet by pressing the lever in the tank cleaning accessory. Make sure the jet is pointing into the tank before pressing the lever.

NB: to adjust the solution jet from the tank cleaning accessory, turn the knob (4) on the accessory itself (Fig.4).

NB: to adjust the intensity of the solution jet from the tank cleaning accessory, turn the knob (5) on the accessory itself (Fig.5).

NB: to stop the solution jet, use the lever (69) on the tank cleaning accessory (Fig.6).

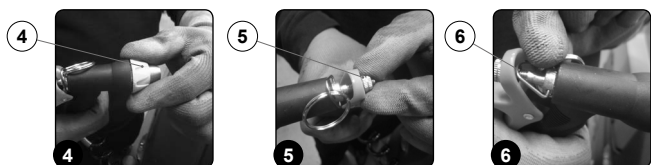

5. Grip the handle (7) on the left-hand side of the recovery tank (Fig.7) and turn the tank cover as far as it will go, until it reaches the maintenance position.

6. Remove the dirty water basket/filter (8) from the support (Fig.8).

7. Remove the basket cover (9) from the basket/filter (8) (Fig.9).

8. Clean the basket/filter and basket cover under the jet of the tank cleaning accessory.

NB: use a spatula or brush to eliminate any dirt that is particularly difficult to remove.



9. Use a cloth to dry the basket/filter and basket cover, and place them back inside the recovery tank.

10. Remove the filter protection cup (10), turning it in the direction of the arrow (Fig.10).

11. Remove the vacuum motor filter (11), taking care not to lose the support tie (12) inside the recovery tank (Fig.11).

12. Rinse the cup and filter thoroughly under the jet of the tank cleaning accessory.

NB: use a spatula to eliminate any dirt that is particularly difficult to remove.

13. Repeat the operations in reverse order to refit everything.

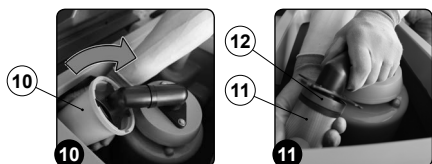

CLEANING THE RECOVERY TANK

To clean the recovery tank (without the optional tank cleaning kit), proceed as follows:

1. Make sure the machine is in a safe condition (see "MACHINE SAFETY MEASURES").

CAUTION: users are advised to always wear protective gloves, to avoid the risk of serious injury to hands.

2. With the recovery tank empty, grip the handle (1) on the left-hand side of the tank (Fig.1) and turn the tank cover as far as it will go, until it reaches the maintenance position.
3. Rinse the inside of the recovery tank with a jet of water. If necessary, use a spatula to remove any sludge that may have accumulated at the bottom of the tank.
4. Repeat the operations in reverse order to reassemble all the parts.



To clean the recovery tank (with the optional tank cleaning kit), proceed as follows:

1. Take the machine to the maintenance area.

CAUTION: users are advised to always wear protective gloves, to avoid the risk of serious injury to hands.

2. Release the recovery tank drainage tube (1) (at the back of the machine) from the retainers (Fig.1).
3. Bend the end of the drainage tube in order to create a choke and prevent the content from coming out (Fig.2), then position the tube on the discharge surface, unscrew the cap, and gradually release the tube.

NB: the place designated for this operation must comply with current environmental protection regulations.

4. With the recovery tank empty, grip the handle (2) on the left-hand side of the recovery tank (Fig.3) and turn the tank cover as far as it will go, until it reaches the maintenance position.



5. Release the tank cleaning accessory (3) (at the back of the machine) from the retainers (Fig.4).

6. Activate the optional tank cleaning kit ON/OFF pump by pressing the button (4) on the back of the machine (Fig.5).

CAUTION: when using the optional tank cleaning kit, you are advised to always wear goggles to avoid any risk of serious injury to your eyes.

NB: before activating the optional tank cleaning kit, check the level indicator (5) to see how much solution there is in the recovery tank (Fig.6).



7. Activate the solution jet by pressing the lever in the tank cleaning accessory. Make sure the jet is pointing into the tank before pressing the lever.

NB: to adjust the solution jet from the tank cleaning accessory, turn the knob (6) on the accessory itself (Fig.7).

NB: to adjust the intensity of the solution jet from the tank cleaning accessory, turn the knob (7) on the accessory itself (Fig.8).

NB: to stop the solution jet, use the lever (8) on the tank cleaning accessory (Fig.9).

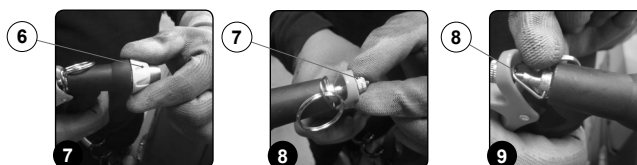

EMPTYING THE SOLUTION TANK

Proceed as follows to empty the solution tank:

1. Take the machine to the maintenance area.
2. Make sure the machine is in a safe condition (see "MACHINE SAFETY MEASURES").

CAUTION: users are advised to always wear protective gloves, to avoid the risk of serious injury to hands.

1. Fully open the tap outflow, rotating the knob (1) in the direction of the arrow (Fig.1).
2. Unscrew the cap (2) of the solution tank drainage system (Fig.2); the cap is located at the rear of the machine.
3. Remove the cap/measuring device (3) (Fig.3), located on the left-hand side of the machine.

NB: the place designated for this operation must comply with current environmental protection regulations.

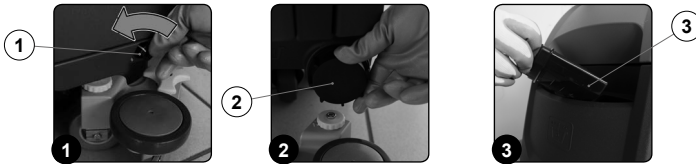

CLEANING THE SOLUTION TANK

Proceed as follows to empty the solution tank:

1. Take the machine to the maintenance area.
2. Make sure the machine is in a safe condition (see "MACHINE SAFETY MEASURES").

CAUTION: users are advised to always wear protective gloves, to avoid the risk of serious injury to hands.

1. Fully open the tap outflow, rotating the knob (1) in the direction of the arrow (Fig.1).
2. Unscrew the cap (2) of the solution tank drainage system (Fig.2); the cap is located at the rear of the machine.
3. Remove the cap/measuring device (3) (Fig.3), located on the left-hand side of the machine.
4. Rinse the inside of the solution tank with a jet of water.
5. With the solution tank empty, repeat the operations in the reverse order to reassemble all the parts.

NB: the place designated for this operation must comply with current environmental protection regulations.

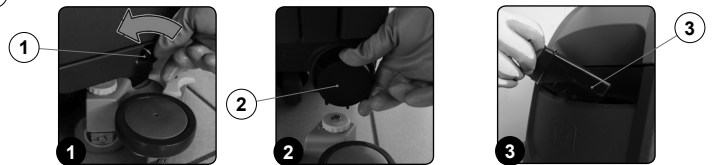

CLEANING THE WATER SYSTEM FILTER

To clean the water system filter, proceed as follows:

1. Take the machine to the maintenance area.
2. Make sure the machine is in a safe condition (see "MACHINE SAFETY MEASURES").

CAUTION: users are advised to always wear protective gloves, to avoid the risk of serious injury to hands.

3. Block the tap outflow, rotating the knob (1) in the direction of the arrow (Fig.1).
4. Go to the right-hand side of the machine and loosen the detergent solution filter cap (2) (Fig.2).
5. Rinse the filter cartridge under a jet of water, and use a brush to eliminate any impurities, if necessary.

NB: the place designated for this operation must comply with current environmental protection regulations.

6. Once the filter cartridge is clean, repeat the operations in the reverse order to reassemble all the parts.

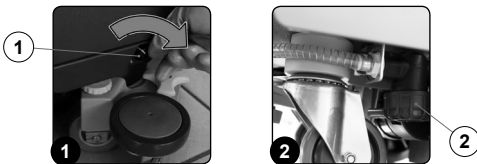

EXTRAORDINARY MAINTENANCE WORK

REPLACING THE BRUSH HEAD BRUSH

The good condition of the brush guarantees better cleaning of the floor, as well as a longer brush head gearmotor lifespan. To replace the brush, proceed as follows:

1. Take the machine to the maintenance area.
2. Make sure the machine is in a safe condition (see "MACHINE SAFETY MEASURES").
3. Go to the front of the machine.
4. Remove the splash guard plate retainers (1) (Fig.1) and lay them carefully on the ground.
5. Press the brush-holder plate retainer (2) and simultaneously rotate the brush in the direction shown in the image (Fig.2).

ATTENTION: Fig.2 shows the rotation direction of the left-hand brush.

6. When brush rotation is prevented, turn until the button on the brush is disengaged from the coupling spring on the brush-holder plate.
7. Repeat the same operation for the right-hand brush.
8. Replace the worn brushes with new ones. With the brush head UP, insert the brush in the plate housing underneath the brush head, turning it until the three buttons engage with the notches on the plate itself.
9. Press the brush-holder plate retainer (2) and simultaneously rotate the brush in the direction shown in the image (Fig.3).

ATTENTION: Fig.3 shows the rotation direction of the left-hand brush.

10. When brush rotation is prevented, turn until the button on the brush is engaged in the coupling spring on the brush-holder plate.
11. Reassemble the brush head splash guard carters.

ATTENTION: these operations must be carried out using protective gloves to avoid any possible contact with the edges or tips of metal objects.



CLEANING THE VACUUM TUBE

Careful cleaning of the vacuum tube guarantees better cleaning of the floor as well as a longer vacuum motor life. Proceed as follows to clean the vacuum tube:

1. Take the machine to the maintenance area.
2. Make sure the machine is in a safe condition (see "MACHINE SAFETY MEASURES").

ATTENTION: users are advised to always wear protective gloves, to avoid the risk of serious injury to hands.

3. Remove the vacuum tube (1) from the vacuum nozzle (2) on the squeegee body (Fig.1).
4. Grip the handle (3) on the left-hand side of the recovery tank (Fig.2) and turn the tank cover as far as it will go, until it reaches the maintenance position.
5. Remove the dirty water basket/filter (4) from the support (Fig.3).
6. Clean the inside of the vacuum duct with a jet of running water.
7. Repeat the operations in reverse order to reassemble all the parts.

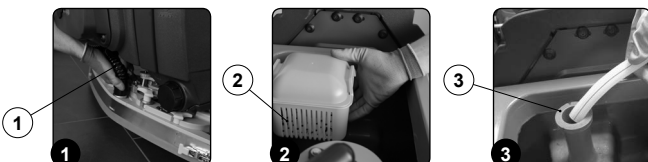

REPLACING THE SQUEEGEE BODY RUBBER BLADES

Ensuring the good condition of the squeegee body rubber blades guarantees better floor cleaning and drying results, as well as a longer service life for the vacuum motor. To replace the squeegee body rubber blades, proceed as follows:

1. Take the machine to the maintenance area.
2. Make sure the machine is in a safe condition (see "MACHINE SAFETY MEASURES").
- CAUTION:** these operations must be carried out using protective gloves to avoid any possible contact with the edges or tips of metal objects.
3. Remove the vacuum tube (1) from the vacuum nozzle on the squeegee body (Fig.1).
4. Completely unscrew the knobs (2) in the squeegee body pre-assembly (Fig.2).
5. Remove the squeegee body from the slits in the squeegee connector (Fig.3).

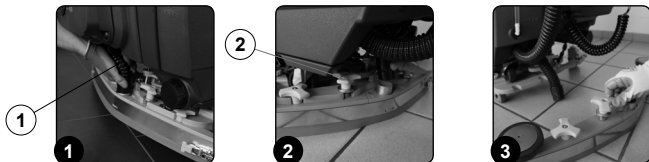

6. Remove the rear rubber-pressing blade by releasing the retainer (3) on the back of the squeegee (Fig.4).
7. Remove the rear rubber blade (4) from the squeegee body (Fig.5).
8. Completely unscrew the knobs (5) in the squeegee body pre-assembly (Fig.6).

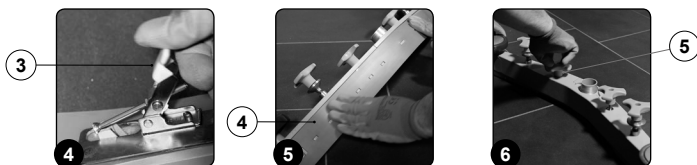

9. Remove the front rubber blade (7) from the inside of the squeegee (Fig.7).
10. Repeat the operations in reverse order to reassemble all the parts.

NB: before using the machine, remember to adjust the squeegee body (see "ADJUSTING THE SQUEEGEE BODY RUBBER BLADES").

NB: you are advised to replace both squeegee body blades in order to ensure good results when drying the floor.

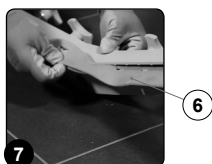

ADJUSTMENT INTERVENTIONS

ADJUSTING THE SQUEEGEE BODY RUBBER BLADES

Careful adjustment of the squeegee body rubber blades guarantees better cleaning of the floor. To adjust the squeegee body blades, proceed as follows:

1. Make sure the machine is in a safe condition (see "MACHINE SAFETY MEASURES").

ATTENTION: these operations must be carried out using protective gloves to avoid any possible contact with the edges or tips of metal objects.

2. Stand at the back of the machine.

Adjusting the height of the squeegee body:

3. Adjust the height of the rubber blade in relation to the floor by loosening or tightening the knobs (1) (Fig.1).

NB: Figure 1 indicates the rotation direction for decreasing the distance between the squeegee support and the floor. This distance can be increased by turning it in the opposite direction.

NB: by decreasing the distance between the squeegee support and the floor, the rubber blades present in the squeegee body move closer to the floor.

NB: the right-hand and left-hand knobs must be rotated the same number of times, so that the squeegee is parallel to the floor when it is working.

NB: make sure the adjustment is correct by looking at the instrument (2) on the squeegee body (Fig.2).

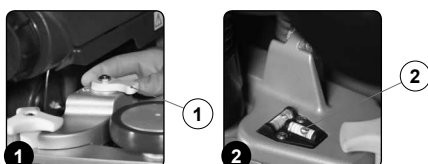

Adjusting the tilt of the squeegee body:

4. Loosen the retainer knob (3) of the squeegee tilt adjustment knob (4) (Fig.3).
5. To adjust the tilt of the squeegee body rubber blades in relation to the floor, tighten or loosen the knob (5) (Fig.4) until the blades are bent outwards by about 30° in relation to the floor, in an even manner along their entire length.

NB: make sure the adjustment is correct by looking at the instrument (6) on the squeegee body (Fig.5).

6. Once the adjustment has been completed, tighten the retainer knob (3).

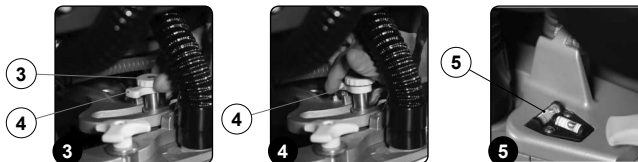

DISPOSAL

To dispose of the machine, take it to a demolition centre or an authorised collection centre. Before scrapping the machine, it is necessary to remove and separate out the following materials, then send them to the appropriate collection centres in accordance with the environmental hygiene regulations currently in force:

- Brushes
- Felt
- Electric and electronic parts*
- Batteries
- Plastic parts (tanks and handlebars)
- Metal parts (levers and frame)

(* In particular, contact your distributor when scrapping electric and electronic parts.

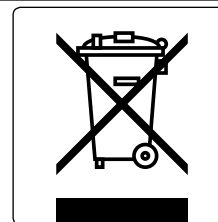

CHOOSING AND USING THE BRUSHES

POLYPROPYLENE BRUSH (PPL)

Used on all types of floors. Good resistance to wear and tear, and hot water (no greater than 50°C.). The polypropylene is non-hygroscopic and therefore retains its characteristics even when working in wet conditions.

ABRASIVE BRUSH

The bristles of this type of brush are charged with highly aggressive abrasives. It is used to clean very dirty floors. To avoid floor damage, work only with the pressure strictly necessary.

THICKNESS OF THE BRISTLES

Thicker bristles are more rigid and are therefore used on smooth floors or floors with small joints. On uneven floors or those with deep joints, it is advisable to use softer bristles which can enter the gaps more easily. Remember that when the bristles are worn and therefore too short, they will become rigid and are no longer able to penetrate and clean deep down. In this case, like with over-large bristles, the brush tends to jump.

PAD HOLDER

The pad holder is recommended for cleaning shiny surfaces. There are two types of pad holder:

1. The traditional pad holder is fitted with a series of anchor points that allow the abrasive floor pad to be held and dragged while working.
2. The CENTRE LOCK type pad holder not only has anchor points, but also a snap-type central locking system in plastic that allows the abrasive floor pad to be perfectly centred and held without any risk of it becoming detached. This type of pad holder is recommended above all for machines with more than one brush, where the centring of the abrasive discs is difficult.

MACHINE	CODE	QTY	BRISTLE	NOTES
TRIDENT T26SC PLUS	422189	2	PPL 0.3	BLUE BRUSH
	422971	2	PPL 0.6	WHITE BRUSH
	422972	2	PPL 0.9	BLACK BRUSH
	422981	2	ABRASIVE	BRUSH
	422973	2		PAD HOLDER WITH CENTRE LOCK

TROUBLESHOOTING

This chapter lists the most common problems linked with the use of the machine. If you are unable to resolve the problems with the information given here, please contact your nearest assistance centre.

PROBLEM	POSSIBLE CAUSE	SOLUTION
THE MACHINE DOES NOT START	The main switch is set to "0".	Make sure the main switch is on "I". If it isn't, turn the key clockwise.
	Check that, when switched on, there are no alarm messages on the control display.	Stop the machine immediately and contact the technician of the specialised service centre, or press the SOS button if the HFM kit is installed.
	Make sure the batteries are correctly connected to each other and that the battery connector is connected to the electrical system connector.	Connect the batteries correctly inside the machine (see INSERTING THE BATTERIES IN THE MACHINE).
	Check the charge level of the batteries.	If the battery charge level is critical, perform a complete recharge cycle (see "RECHARGING THE BATTERIES").
THE BATTERIES ARE NOT CHARGED CORRECTLY (VERSIONS WITH BUILT-IN BATTERY CHARGER)	The plug on the battery charger cable is not correctly inserted in the socket on the battery charger itself.	Reconnect the battery charger power cable.
	The plug on the battery charger power cable is not correctly inserted in the electrical outlet.	Check that the battery charger power supply cable plug is connected to the mains socket.
	The characteristics of the mains power supply do not correspond to those required by the battery charger.	Check that the characteristics in the battery charger plate are the same as those of the mains supply.
	The LEDs of the battery charger blink repeatedly.	Referring to the battery charger use and maintenance manual, check the meaning of the flashing signals that the battery charger emits during the battery recharge stage.
THE MACHINE HAS A VERY LOW WORKING AUTONOMY	Check the battery charge level (check the symbol on the control display).	If the battery charge level is critical, perform a complete recharge cycle (see "RECHARGING THE BATTERIES").
THE MACHINE DOES NOT MOVE	The machine does not start.	Read the section "THE MACHINE DOES NOT START" .
	There is a drive pedal fault.	Contact your nearest service centre.
NOT ENOUGH DETERGENT SOLUTION ON THE BRUSH	The quantity of detergent solution in the water system is not sufficient for the work to be carried out.	Check that the amount of detergent solution present in the machine water system is sufficient for the work to be carried out.
	Detergent solution filter obstructed.	Check the detergent solution filter isn't obstructed. If it is, clean it (see "CLEANING THE WATER SYSTEM FILTER").
THE MACHINE DOES NOT CLEAN CORRECTLY	The machine does not start.	Read the section "THE MACHINE DOES NOT START" .
	Not enough detergent solution comes out.	Read the section "NOT ENOUGH DETERGENT SOLUTION ON THE BRUSH" .
	The brushes have not been inserted correctly in the machine.	Check that the disc brushes have been correctly inserted in the machine (see "ASSEMBLING THE BRUSH").
	The type of brush used is not suitable for the dirt to be removed.	Make sure the brushes fitted on the machine are suitable for the work to be carried out (see "CHOOSING AND USING THE BRUSHES").
THE SQUEEGEE DOES NOT DRY PERFECTLY	The brush bristles are excessively worn.	Check the condition of the brush, and replace it if necessary (see "REPLACING THE BRUSH HEAD BRUSH").
	The vacuum unit is obstructed.	Make sure the squeegee is free of obstructions (see "CLEANING THE SQUEEGEE BODY").
		Make sure the vacuum tube is free of obstructions (see "CLEANING THE VACUUM TUBE").
		Make sure the vacuum cap filter is free of obstructions (see "CLEANING THE RECOVERY TANK FILTERS").
		Make sure the vacuum motor filter is free of obstructions (see "CLEANING THE RECOVERY TANK FILTERS").
The cap on the recovery tank drainage tube is not properly positioned.	Check that the cap on the recovery tank drainage tube is positioned properly.	
The recovery tank lid is not positioned correctly.	Check that the recovery tank lid is properly positioned on the machine.	
EXCESSIVE FOAM PRODUCTION	The detergent being used is not suitable.	Check that a low foam detergent has been used. If necessary, add a small quantity of antifoam liquid to the recovery tank.
	The floor is not very dirty.	Dilute the detergent more.
THE MACHINE DOES NOT VACUUM CORRECTLY	The recovery tank is full.	Empty the recovery tank (see "EMPTYING THE RECOVERY TANK").
	The vacuum device is obstructed	Read the section "THE SQUEEGEE DOES NOT DRY PERFECTLY" .

