



Thank you for purchasing Leick Furniture products.
Contact customer service for comments or concerns.

Sheboygan, WI







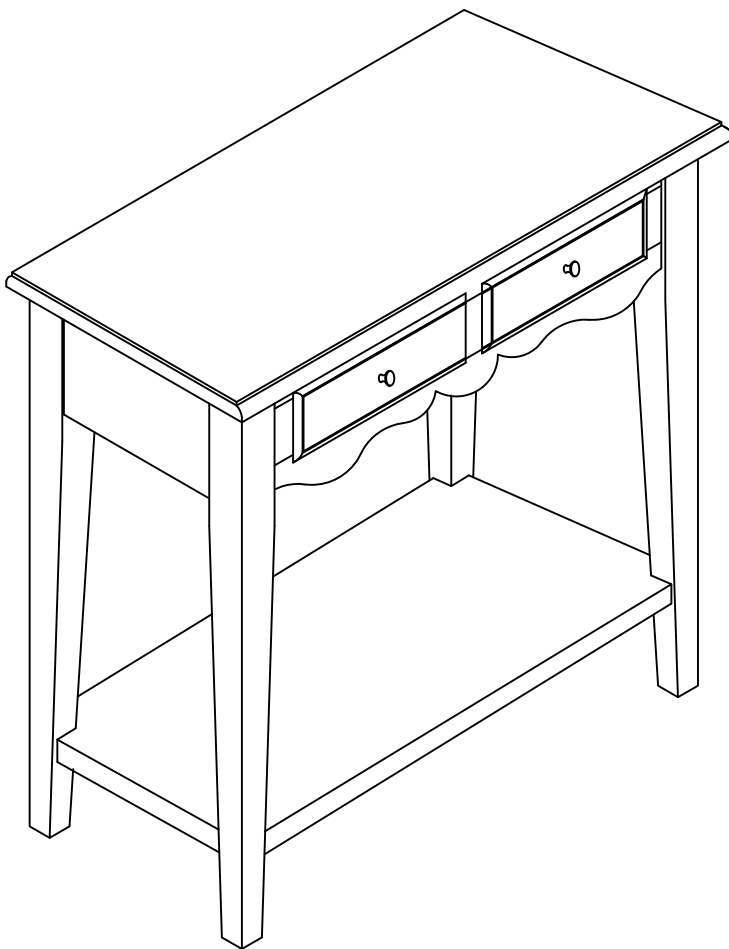

920-451-4060

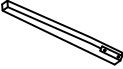
info@leickfurnituresince1910.com

www.leickfurnituresince1910.com

Assembly Instructions, #9027 Petite Console



A: Top Assembly	
B: (4) Legs	
C: (8) Flat washers	
D: (8) Lock Washers	
E: (8) Bolts	
F: Allen Wrench	
G: Shelf	
H: (4) Shelf Supports	
I : (2) Extra Drawer Glides	

Step 1

Remove drawer and place the top assembly upside down. Fasten the legs with (8) bolts, flat washers and lock washers. Do not tighten yet.

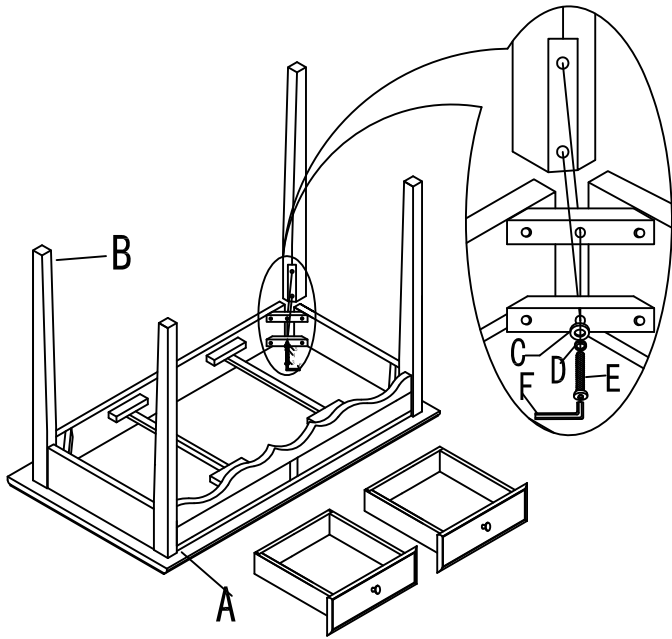

Step 2

Place the table right side up and put the shelf on shelf supports.

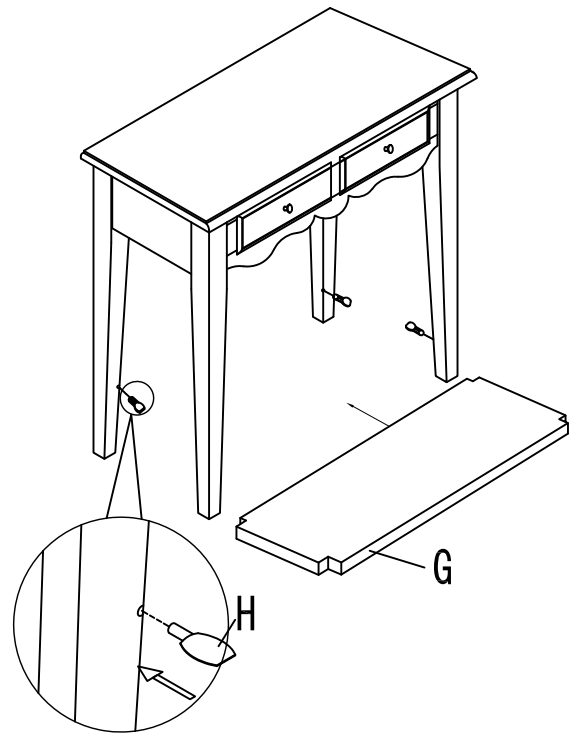

Step 3

Now tighten the bolts in Step 1 and put the drawers back into the table.

