

# **CLEAR VIEW LEVER ACTION GREASE GUN**

*PISTOLA PARA GRASA CON PALANCA*

Item Number W54293

## **OWNER'S MANUAL / INSTRUCTIVO**



*Performance Tool*

### **SPECIFICATIONS / CARACTERÍSTICAS**

Capacity:..... Bulk - 16 oz. (473 ml), Cartridge - 14 oz. (414 ml)  
Develops up to:..... 10,000 PSI  
Delivers:..... 1 oz. / 18 Strokes (29.5 ml)  
Hose Type / Length: ..... 6 in. Rigid 1/8 in. NPT

**Specifications are subject to change without notice.**

**▲WARNING: READ, UNDERSTAND AND FOLLOW ALL INSTRUCTIONS AND WARNINGS BEFORE OPERATING THIS TOOL. FAILURE TO DO SO MAY RESULT IN PERSONAL INJURY AND/OR PROPERTY DAMAGE AND WILL VOID WARRANTY.**

**PT**<sup>®</sup>  
Performance Tool

## GREASE CARTRIDGE LOADING / PARA LLENAR CARTUCHO DE GRASA

**NOTE:** This is a basic instruction manual which covers various models of grease guns. The illustrations below may not depict exactly your specific gun.

1. Rotating counter clockwise, unscrew Head Cap from gun Barrel. (Fig. 1)

**NOTA:** Este es un manual de instrucciones básico que cubre varios modelos de pistolas de grasa. Las ilustraciones de abajo pueden no ser exactamente iguales que su pistola específica.

1. Desatornille la tapa del barril de la pistola girando en dirección opuesta a las manecillas del reloj. (Fig. 1)

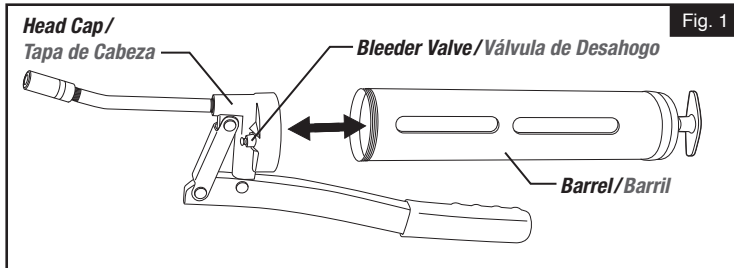

**NOTE:** Because they lack lubrication on the rubber plunger, new grease guns may be difficult to load with grease cartridges the first time. Apply a liberal coating of grease to plunger when using gun for the first time. **This grease gun requires a 14 oz. grease cartridge.**

2. Draw handle back fully so that the plunger rod catches and locks into place. (Fig. 2)

**CAUTION:** Depressing the lock release when empty causes the handle to snap back quickly.

3. After removing the plastic cap from the grease cartridge, apply a small amount of grease to the inside edge of the cartridge. This will make insertion of the plunger easier. (Fig. 3)

4. Push grease cartridge into gun barrel completely, until metal edge tightly seals on top of the grease gun barrel. Detach flip-top seal from cartridge. (Fig. 4)

5. Screw on head cap approximately two turns, being sure not to tighten. Release plunger rod from its locked position and push in. Push on plunger rod handle to force plunger into cartridge. At the same time, pump the lever or handle to release trapped air. When grease comes through vents and the head of the gun, fully tighten the head cap to the barrel.

6. As soon as the gun is pumping grease, carefully depress the lock release and push plunger rod back into gun.

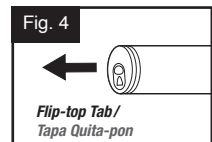
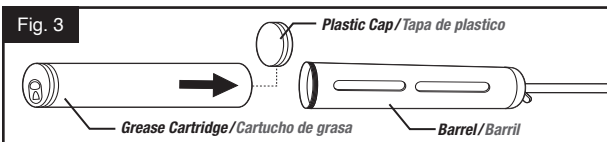
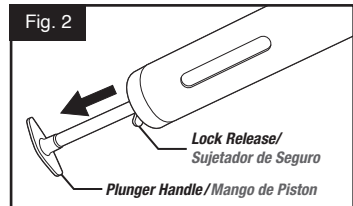

**NOTA:** Debido a la escasa lubricación del piston de goma, puede ser difícil llenar la primera vez de grasa los cartuchos. Aplique una capa suficiente de grasa a el piston cuandose usa la pistola por primera vez. **Esta pistola de grasa requiere un cartucho de grasa de 397 g.**

2. Jale completamente el mango hacia atras para que la cabeza del piston se asegure en su lugar (Fig. 2)

**PRECAUCIÓN:** Si se jala el sujetador del seguro al estar vacio, causa que el mango haga repentinamente para atras.

3. Después de remover la tapa de plastico del cartucho de grasa, aplique una pequeña cantidad de grasa al borde interior del cartucho. (Fig. 3)

4. Empuje el cartucho de grasa hacia el barril completamente, hasta que el metal selle con la parte superior de la pistola de grasa. Retire le sello de arriba del cartucho. (Fig. 4)

5. Atornille la cabeza de la tapa aproximadamente dos vueltas, asegurandose que no apriete. Saque el piston de su posición asegurada. Empuje el mango para forzar la cabeza del piston contra el cartucho. Al mismo tiempo, bombee el mango para liberar el aire. Cuando la grasa salga de los extremos de la pistola, apriete la cabeza de la tapa contra al barril.

6. Al momento que la pistola bombee grasa, cuidadosamente jale el sujetador del seguro y empuje la cabeza del piston de vuelta en la pistola.

## BULK LOADING WITH DISPENSER/RELLENO EN VOLUMEN CON DISPENSADOR

**NOTE:** Used cartridges must be removed prior to bulk loading.

1. Make sure the bulk loading filler valve is compatible with the adapter on the pump. (Figure 5)
2. Attach the filler valve to the adapter by pushing in and rotating slightly.
3. Operate the pump handle while holding the gun firmly to the pump. As the grease pumps into the grease gun barrel the plunger handle will extend. Loading is complete when the plunger rod is fully extended.
4. A slight twist of the gun will detach it from the pump. Depress lock release and push the plunger rod back into the gun.

**NOTA:** Los cartuchos usados de deben remover antes de ser recargados en volumen.

1. Asegurese que la válvula sea compatible con el adaptador en la bomba. (Fig. 5)
2. Sujete la válvula de relleno al adaptador empujandola y rotando ligeramente.
3. Opere el mango de la bomba mientras sujeta la pistola firmemente hacia la bomba. La barra del piston se extendera al momento de entrar la grasa al barril. El relleno se termina cuando la barra del piston esta completamente extendida.
4. La pistola se desprende de la bomba con un pequeño giro. Quite el sujetador del seguro y empuje la barra del piston de nuevo en la pistola.

**⚠ WARNING / PRECAUCIÓN**  
DO NOT REFILL  
USED CARTRIDGES  
NO RELLENE CARTUCHOS  
USADOS

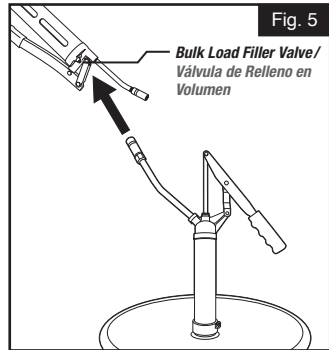

## SUCTION FILLING/RELLENO A SUCCIÓN

**NOTE:** Used cartridges must be removed prior to suction filling.

1. Remove the gun head cap from the barrel.
2. Submerge open end of the barrel into grease bucket. Be sure the plunger handle is depressed completely. Grasp the barrel firmly and pull back slowly on the plunger handle. Be sure the mouth of the barrel is always under the surface so that air is not transferred into the barrel. (Figure 6)
3. Loading is complete when plunger rod is fully extended.
4. Reattach the gun head cap to the barrel. Depress lock release and push the plunger rod back into the gun.

**NOTE:** Grease guns may lose their prime on occasion, because of air pockets in the grease. If this occurs, remove the trapped air by bleeding the head cap and resume pumping.

**NOTA:** Los cartuchos usados se deben remover antes de llenar a succión.

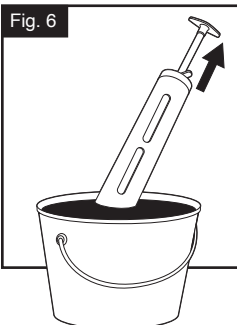

1. Remueva la tapa de la cabeza de la pistola del barril.
2. Sumerja la parte abierta del barril en el cubo de grasa. Aseruse que el mango del piston esta completamente suelto. Sujete el barril firmemente y jale despacio el mango del piston. Asegurese que la boca del barril este siempre sumergida en el cubo para que no pase aire a el barril. (Fig. 6)
3. El relleno se termina cuando la barra del piston esta completamente extendida.
4. Ponga de nuevo la tapa de la cabeza de la pistola a el barril. Quite el sujetador del seguro y ponga la barra del piston de nuevo en la pistola.

**NOTA:** En ocasiones las pistolas de grasa pueden perder su fuerza debido a bolsas de aire en la grasa, si esto ocurre, remueva el aire atrapado purgando la tapa de la cabeza y siga bombeando.

# TROUBLE SHOOTING

Problem:	Possible cause:	Solution:
Coupler won't fit or stay on the grease fitting.....	Grease couplers jaws are threaded closed.	The coupler has adjustable jaws. Twist nose of coupler, this will open and close the 4 internal jaws.
When gun is operated grease escapes from around the fitting and/or coupler.....	Either fitting is plugged with solidified grease, or couplers not tight enough on fitting.	Coupler is adjustable, a slight turn of the nose opens the jaws. Turn the nose the opposite direction to firm up the connection. Positive pressure will ensure grease enters grease fitting, and coupler won't detach. Done correctly this can clear out any solidified grease without needing to clean fitting.
 <div style="border: 1px solid black; padding: 5px; display: inline-block; margin-top: 10px;"> <p><i><b>NOTE: Twist coupler head to open and close the jaws, to fit different sizes of fittings.</b></i></p> </div>		
Grease gun pumps little or no grease.....	Air is trapped in head of the grease gun.	Unscrew the barrel of the grease gun two turns. Move Plunger rod back & forth in and out to force out any trapped air. Expel air by pressing the air purge valve or pumping the handle.
	Blocked hose.	Remove the hose and operate the grease gun. If the gun dispenses grease then the gun is fine and you need to either clean the extension or replace it.
	Grease too thick or cold.	Store grease gun and grease away from extreme cold, best if stored at room temp..

## LIMITED WARRANTY

PERFORMANCE TOOL® extends only the following warranties, and only to original retail purchasers. These warranties give specific legal rights. Except where prohibited by local law, the law of the State of Washington governs all warranties and all exclusions and limitations of warranties and remedies. There may be other rights which vary from state to state.

PERFORMANCE TOOL® warrants the product to be free from defects in materials and workmanship under normal use and service. A defective product may be returned for a free replacement within 90 days from the date of purchase, provided that product is returned to place of purchase immediately after discovery of defect. After 90 days PERFORMANCE TOOL® will replace at no charge any parts which our examination shall disclose to be defective and under warranty. These warranties shall be valid only when a sales receipt showing the date of purchase accompanies the defective product or defective part (s) being returned. For part (s) after 90 days, please remit your request, postage prepaid to:

PERFORMANCE TOOL, P.O. Box 88259 Tukwila, WA 98138

These warranties exclude blades, bits, punches, dies, bulbs, fuses, hoses, and other consumables which must be replaced under normal use and service. These warranties shall not apply to any product or part which is used for a purpose for which it is not designed, or which has been repaired or altered in any way so as to affect adversely its performance or reliability, nor shall these warranties apply to any product or part which has been subject to misuse, neglect, accident or wear and tear incident to normal use and service.

PERFORMANCE TOOL® does not authorize any other person to make any warranty or to assume any liability in connection with its products.

Except for warranties of title and the limited express warranties set forth above, PERFORMANCE TOOL® makes no express or implied warranties of any kind with respect to its products. In particular, PERFORMANCE TOOL® makes no implied warranty of merchantability and no implied warranty of fitness for any particular purpose, except that for goods purchased primarily for personal, family or household use and not for commercial or business use, PERFORMANCE TOOL® makes an implied warranty of merchantability (and, if otherwise applicable, an implied warranty of fitness for a particular purpose), but only for the particular qualities or characteristics, and for the duration, expressly warranted above.

The laws on limitation of implied warranties may differ from state to state, so the above limitations may not apply in all cases.

PERFORMANCE TOOL® shall not be liable for consequential, incidental or special damages resulting from or in any manner related to any product, or to the design, use, or any inability to use the product. The sole and exclusive remedy for a defective product or part shall be the repair, or replacement thereof as provided above. The laws on limitation of remedies or on consequential, incidental or special damages may vary from state to state, so the above limitations may not apply in all cases.