

Medusa

HEL-BPH180

180 Degree
Glass-to-Glass
Pivot Hinge

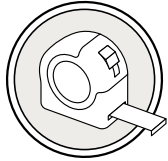

Do not measure images.
Use specified dimensions.

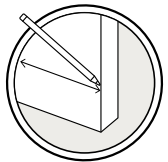

Measure from finished
edge of glass.

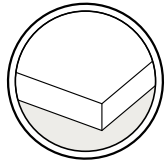

Use monolithic glass.

- > **Glass Sizes:**
5/16" (8mm) to 3/8" (10mm) thick
tempered safety glass

- > **Maximum Door Capacities
for Two Hinges:**

Maximum Door Weight:
100 lbs. (46 kg)

Maximum Door Width:
31" (787mm)

Edge Mount Preferred Method 1/8" (3mm) to 3/16" (5mm) Clearance

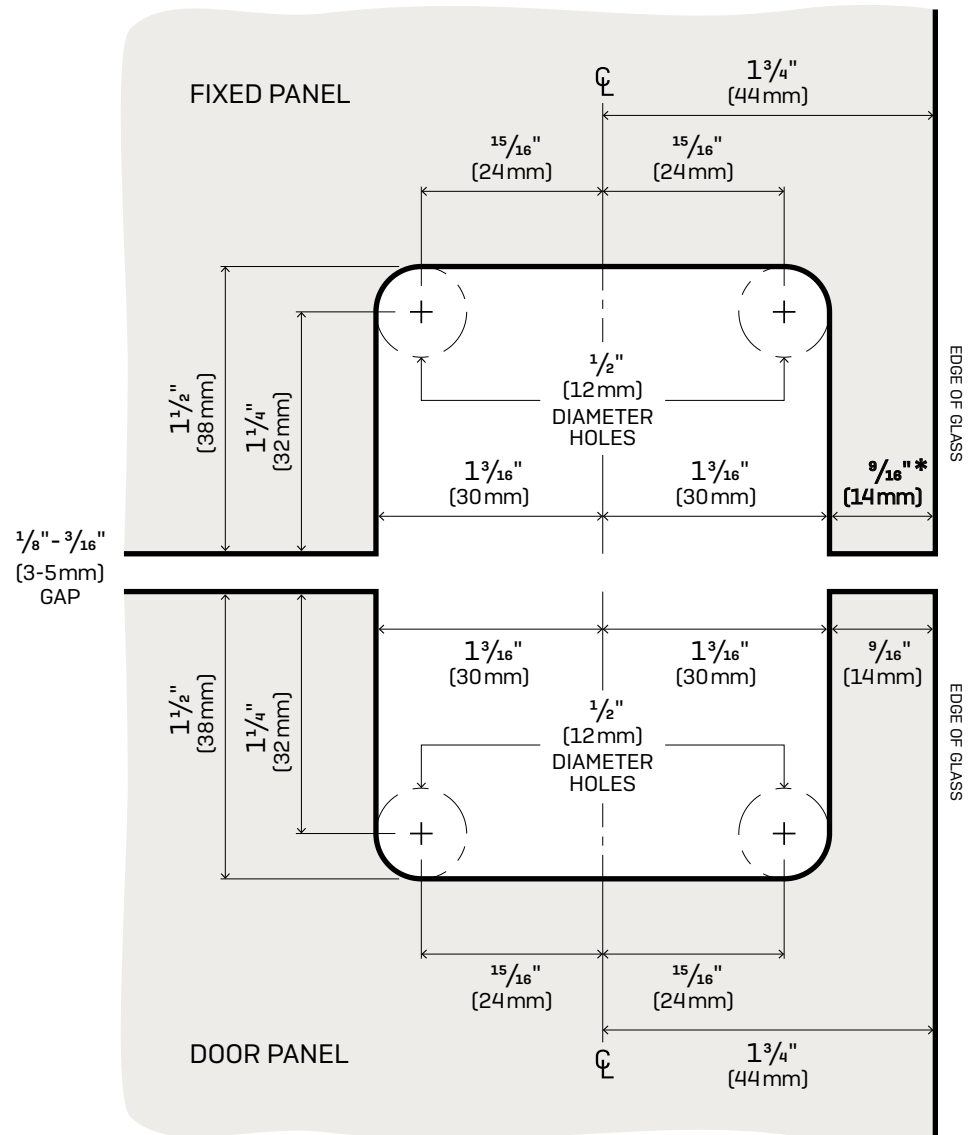
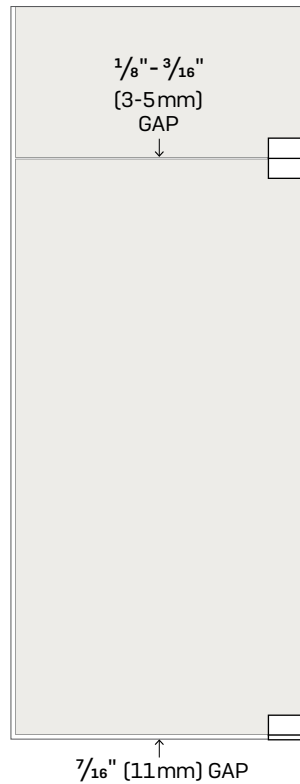

- * The 9/16" (14mm) measurement on the fixed panel outer edge is dependent on the horizontal alignment of the fixed panel being inline with the door panel outer edge. If the fixed panel location is not inline with the door panel, revise this measurement and adjust accordingly.

Medusa

HEL-BPH180

180 Degree
Glass-to-Glass
Pivot Hinge

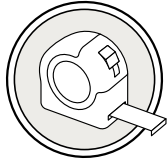

Do not measure images.
Use specified dimensions.

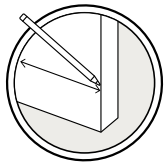

Measure from finished
edge of glass.

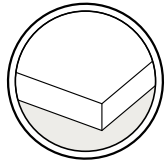

Use monolithic glass.

- > **Glass Sizes:**
5/16" (8mm) to 3/8" (10mm) thick
tempered safety glass

- > **Maximum Door Capacities
for Two Hinges:**

Maximum Door Weight:
100 lbs. (46 kg)

Maximum Door Width:
31" (787mm)

Edge Mount Alternate Method 1/8" (3mm) to 3/16" (5mm) Clearance

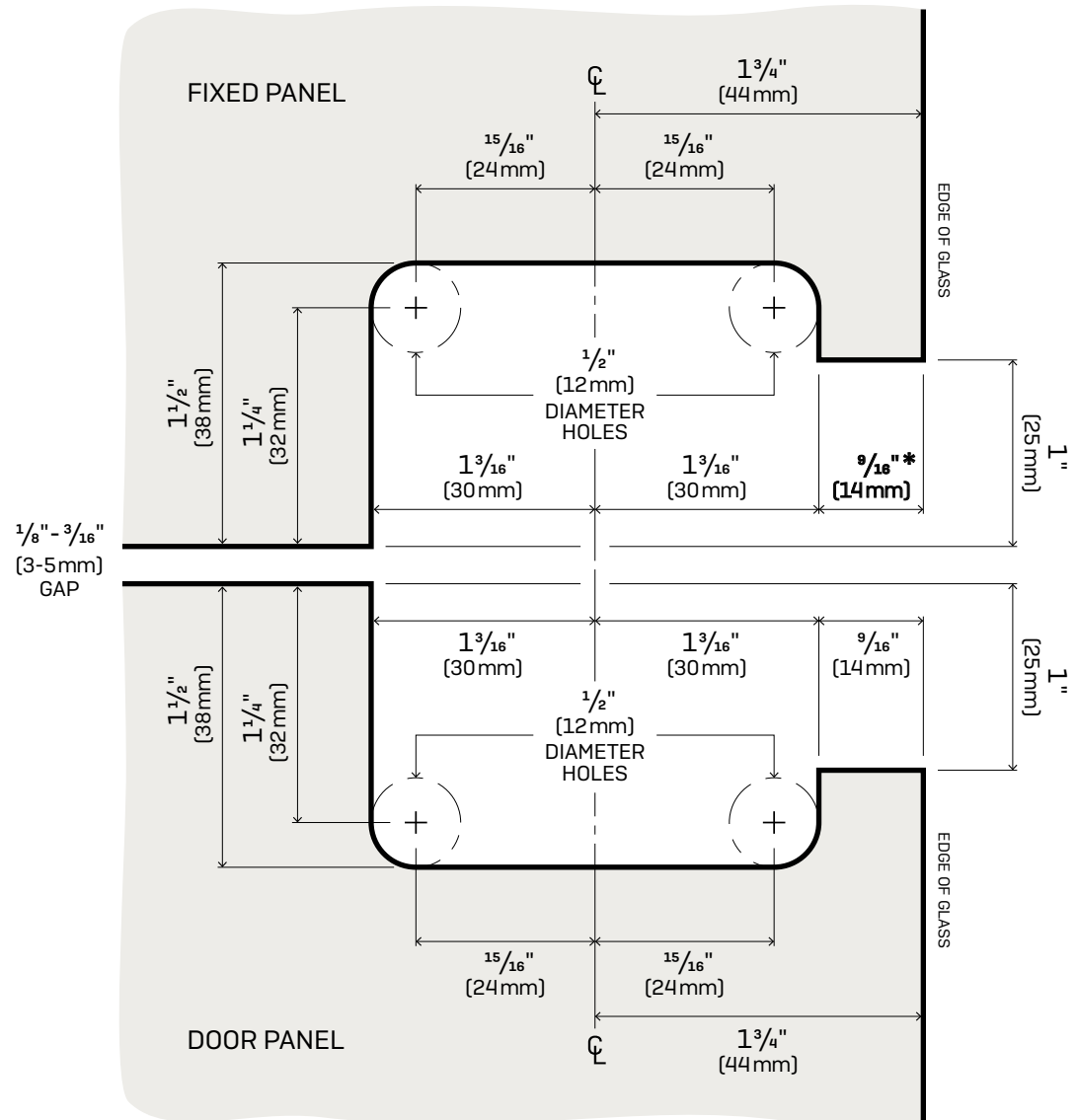
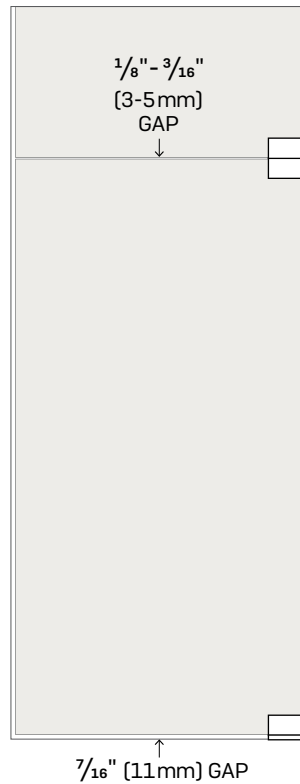

- * The 9/16" (14mm) measurement on the fixed panel outer edge is dependent on the horizontal alignment of the fixed panel being inline with the door panel outer edge. If the fixed panel location is not inline with the door panel, revise this measurement and adjust accordingly.

Medusa

HEL-BPH180

180 Degree
Glass-to-Glass
Pivot Hinge

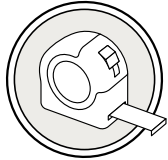

Do not measure images.
Use specified dimensions.

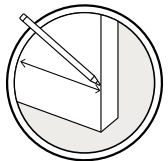

Measure from finished
edge of glass.

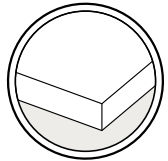

Use monolithic glass.

> **Glass Sizes:**
5/16" (8mm) to 3/8" (10mm) thick
tempered safety glass

> **Maximum Door Capacities
for Two Hinges:**

Maximum Door Weight:
100 lbs. (46 kg)

Maximum Door Width:
31" (787mm)

Variable Inset Mount Method 1/8" (3mm) to 3/16" (5mm) Clearance



1/8" - 3/16"
(3-5mm)
GAP

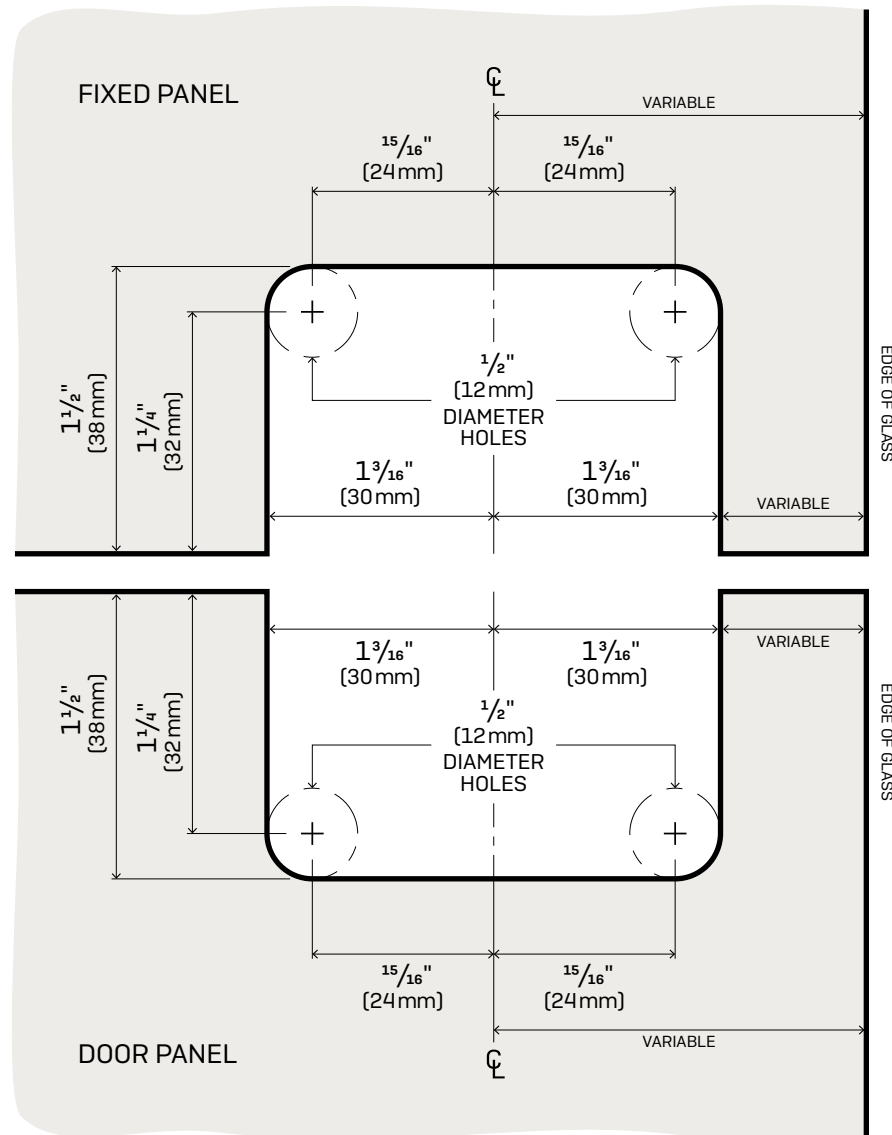

Medusa

HEL-BPH180

180 Degree
Glass-to-Glass
Pivot Hinge

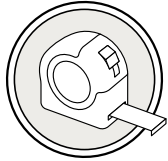

Do not measure images.
Use specified dimensions.

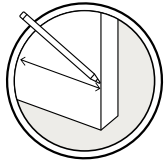

Measure from finished
edge of glass.

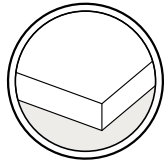

Use monolithic glass.

> **Glass Sizes:**
5/16" (8mm) to 3/8" (10mm) thick
tempered safety glass

> **Maximum Door Capacities
for Two Hinges:**

Maximum Door Weight:
100 lbs. (46 kg)

Maximum Door Width:
31" (787mm)

Transom Mount Method 1/8" (3mm) to 3/16" (5mm) Clearance

